



# EVM54304-MN-01A

## 4V to 16V Input, Four-Channel Output Power Module with an I<sup>2</sup>C Interface and MTP Evaluation Board

### DESCRIPTION

The EVM54304-MN-01A is an evaluation board designed to demonstrate the capabilities of the MPM54304, a four-channel output power module with an I<sup>2</sup>C interface. Channels 1 and 2 can deliver up to 3A (or a shared 6A) of continuous output current. Channels 3 and 4 can deliver up to 2A (or a shared 4A) of continuous output current. The MPM54304 integrates four high-efficiency, step-down DC/DC converters, four inductors, and an I<sup>2</sup>C interface.

Channels 1 and 2 can be paralleled to provide up to 6A of output current. Channels 3 and 4 can be paralleled to provide up to 4A of output current. The MPM54304 features constant-on-time (COT) control to provide fast load transient response.

The output voltage ( $V_{OUT}$ ) can be configured via the I<sup>2</sup>C bus or preset two times by the multiple-time programmable (MTP) e-fuse.  $V_{OUT}$  can also be adjusted via the external resistor divider. When  $V_{OUT}$  is set via the resistor divider, each channel's soft-start time is the same. The start-up and shutdown sequences are configurable via the MTP.

The MPM54304 requires a minimal number of external components, and is available in a space-saving LGA (7mmx7mmx2mm) package.

### ELECTRICAL SPECIFICATIONS

Parameter	Symbol	Value	Units
Input voltage	$V_{IN}$	12	V
Output voltage (channels 1, 2, 3, and 4)	$V_{OUT}$	1, 3.3, 1.8, 1.5 <sup>(1)</sup>	V
Output current (channels 1, 2, 3, and 4)	$I_{OUT}$	3, 3, 1, 1 <sup>(2)</sup>	A

#### Notes:

- 1) The evaluation board's default voltage value can be configured by the I<sup>2</sup>C.
- 2) The output current can also be set to 3A, 2A, 2A, 2A.

### FEATURES

- 4V to 16V Operating Input Voltage Range
- Wide Output Voltage Range
- 0.55V to 5.4V Configurable I<sup>2</sup>C Interface
- 0.6V to 7V or  $V_{IN} \times D_{MAX}$  (If  $V_{IN}$  Exceeds 7V) External Resistor Divider
- Continuous Output Current ( $I_{OUT}$ )
  - Channels 1 and 2: 3A, Shared 6A
  - Channels 3 and 4: 2A, Shared 4A
- Interleaved Operation
- Configurable, Multi-Functional GPIO Pin
- I<sup>2</sup>C Interface and Configurable Parameters
  - Paralleled Channels 1 and 2
  - Paralleled Channels 3 and 4
  - Switching Frequency ( $f_{sw}$ )
  - Output Voltage ( $V_{OUT}$ )
  - Over-Current Protection (OCP) Threshold
  - Over-Voltage Protection (OVP) Threshold
  - Start-Up and Shutdown Sequencing
  - Forced Pulse-Width Modulation (PWM), Auto-PWM, and Auto-Pulse Frequency Modulation (Auto-PFM) Modes
- Preset to MPM54304GMN-0000 Configuration
- Available in an LGA (7mmx7mmx2mm) Package

### APPLICATIONS

- Field-Programmable Gate Arrays (FPGAs)
- Multi-Rail Power Systems
- Microcontroller (MCU) Power Supplies
- Digital Signal Processors (DSPs)

All MPS parts are lead-free, halogen-free, and adhere to the RoHS directive. For MPS green status, please visit the MPS website under Quality Assurance. "MPS", the MPS logo, and "Simple, Easy Solutions" are registered trademarks of Monolithic Power Systems, Inc. or its subsidiaries.

### EVM54304-MN-01A EVALUATION BOARD

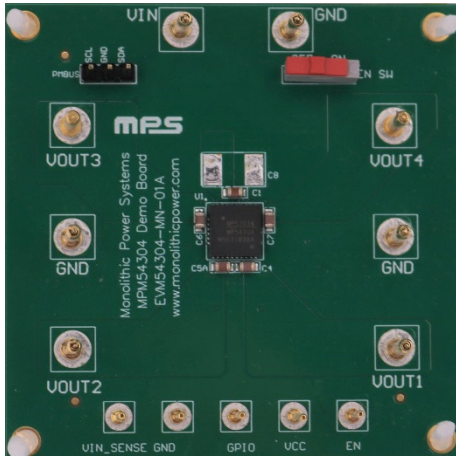

LxW (63.5mmx63.5mm)

Board Number	MPS IC Number
EVM54304-MN-01A	MPM54304GMN-0000

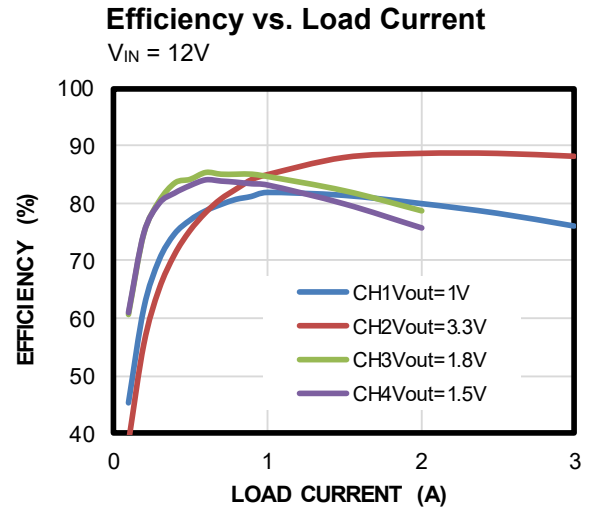

## QUICK START GUIDE

1. Preset the power supply to 12V, then turn off the power supply.
2. Connect the power supply terminals to:
  - a. Positive (+): VIN
  - b. Negative (-): GND
3. Connect VOUT1, VOUT2, VOUT3, VOUT4, and GND to the load terminals:
  - a. Positive (+): VOUT1, VOUT2, VOUT3, and VOUT4
  - b. Negative (-): GND
4. After making the connections, turn on the power supply and the EN switch. The board should automatically start up.
5. To configure the I<sup>2</sup>C interface:
  - a. Connect the SCL, SDA, and GND pins to the I<sup>2</sup>C start kit board.
  - b. Connect the I<sup>2</sup>C start kit board to a PC.
  - c. Run the MPM54304 GUI software to program the MPM54304 I<sup>2</sup>C registers. <sup>(3)</sup>

**Notes:**

- 3) The GUI software can be downloaded from the MPS website.

### EVALUATION BOARD SCHEMATIC

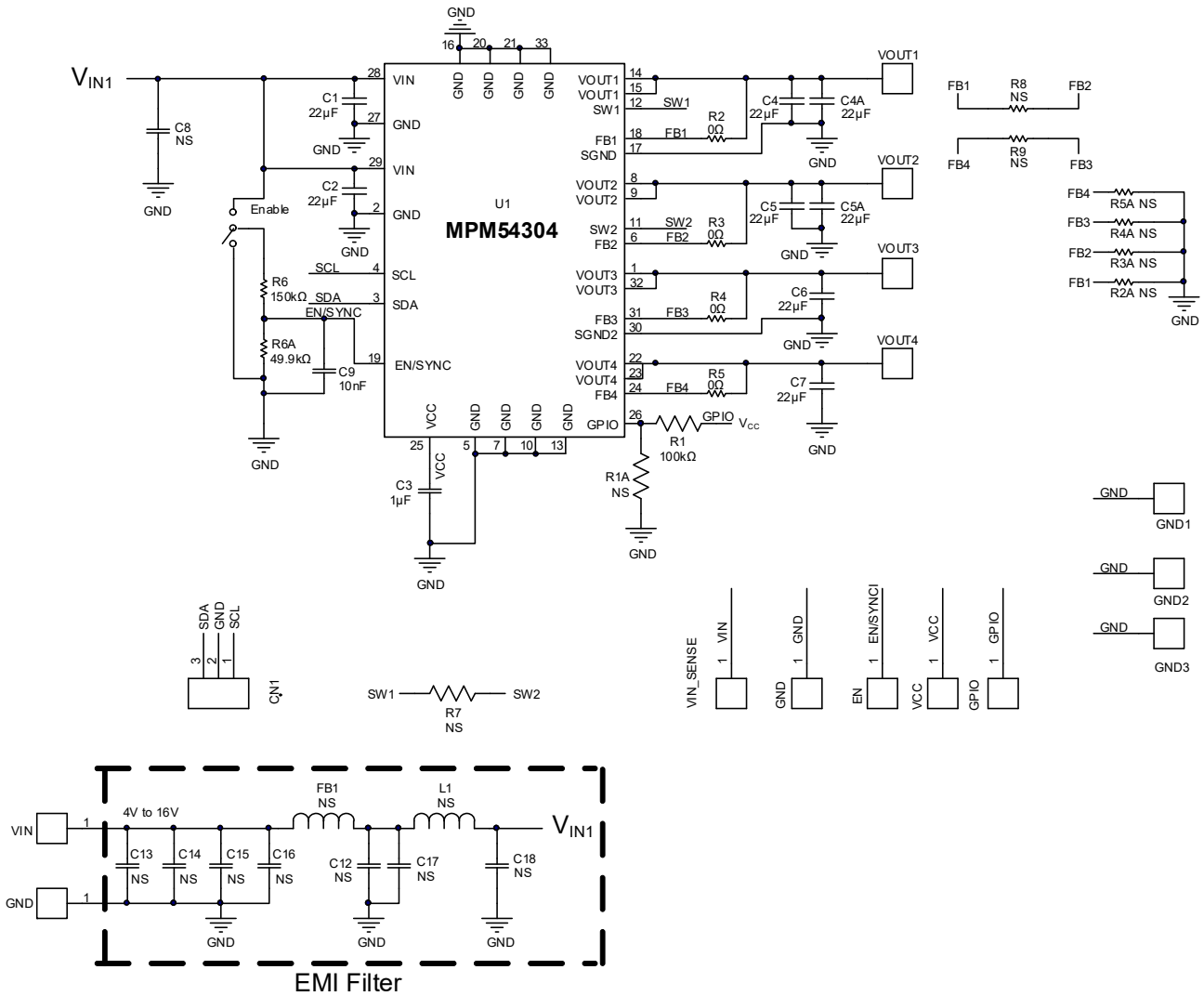

Figure 1: Evaluation Board Schematic

**EVM54304-MN-01A BILL OF MATERIALS**

Qty	Ref	Value	Description	Package	Manufacturer	Manufacturer PN
8	C1, C2, C4, C5, C6, C7, C4A, C5A	22μF	Ceramic capacitor, 25V, X5R	0805	Murata	GRM21BR61E226ME44L
1	C3	1μF	Ceramic capacitor, 16V, X6S	0402	Murata	GRM155C81C105KE11D
1	C9	10nF	Ceramic capacitor, 16V, X7R	0402	Murata	GRM155R71C103KA01D
1	R6	150kΩ	Film resistor, 1%	0603	Yageo	RC0603FR-07150KL
1	R6A	49.9kΩ	Film resistor, 1%	0603	Yageo	RC0603FR-0749K9L
4	R2, R3, R4, R5	0Ω	Film resistor, 1%	0603	Yageo	RC0603FR-070RL
1	R1	100kΩ	Film resistor, 1%	0402	Yageo	RC0402FR-07100KL
1	PMBus		3 pins, 1 row, straight	DIP	Wurth	61300311121
1	Switch		Tact switch, on-on, vertical type, through hole technology, bulk	DIP	Wurth	450301014042
1	U1	MPM54304	PMIC module	LGA (7mmx 7mmx2mm)	MPS	MPM54304GMN-0000

## EVB TEST RESULTS

Performance curves and waveforms are tested on the evaluation board.  $V_{IN} = 12V$ ,  $V_{OUT1} = 1V$ ,  $V_{OUT2} = 3.3V$ ,  $V_{OUT3} = 1.8V$ ,  $V_{OUT4} = 1.5V$ ,  $f_{SW} = 800kHz$ ,  $T_A = 25^{\circ}C$ , continuous conduction mode (CCM), unless otherwise noted.

**Efficiency vs. Load Current vs. Power Loss**

$V_{IN} = 12V$

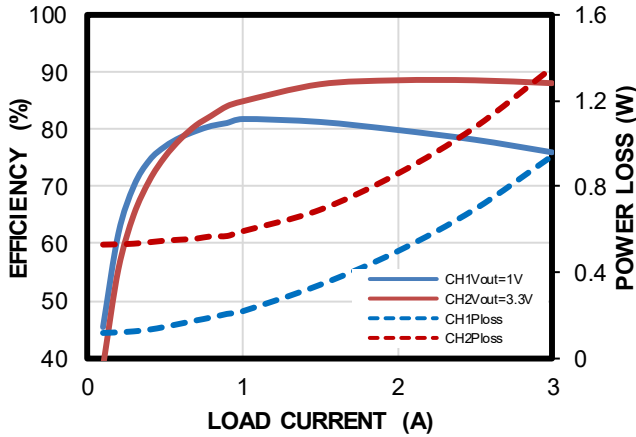

**Efficiency vs. Load Current**

$V_{IN} = 12V$

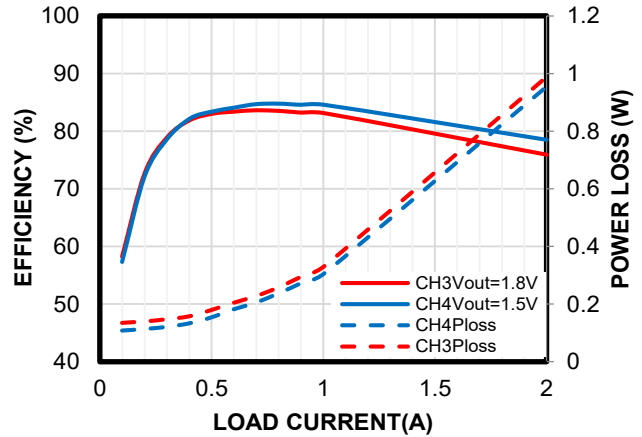

**Load Regulation vs. Load Current**

$V_{IN} = 12V$

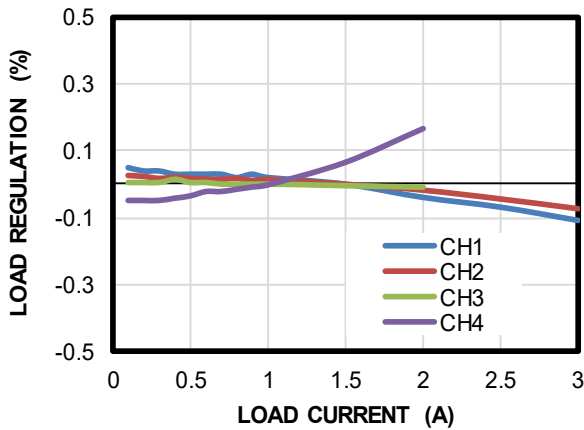

**Line Regulation vs. Input Voltage**

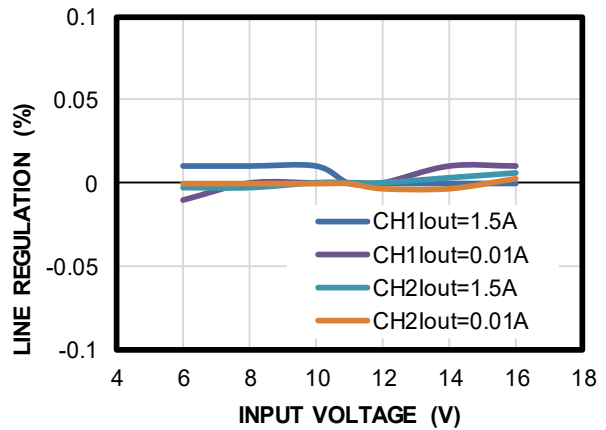

**Line Regulation vs. Input Voltage**

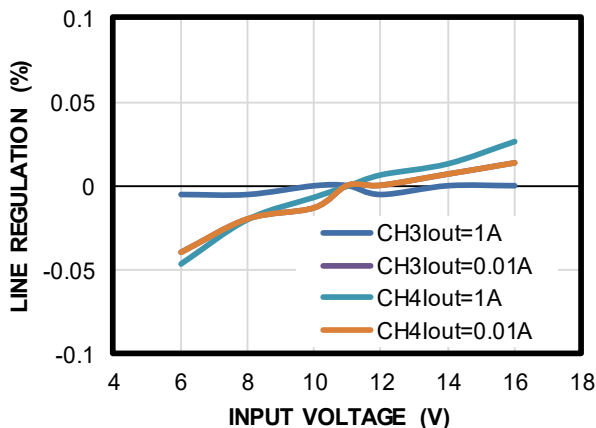

**Max Power Loss vs. Temperature**

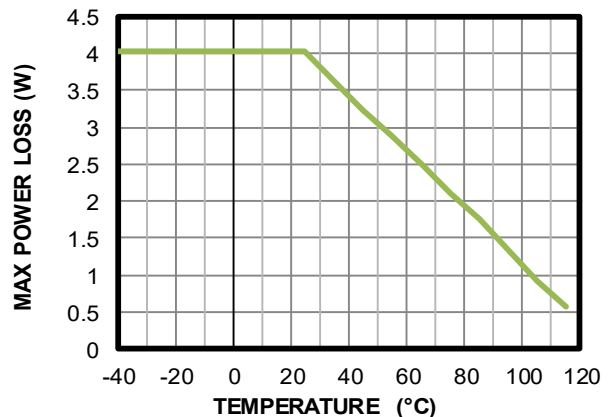

### EVB TEST RESULTS (continued)

Performance curves and waveforms are tested on the evaluation board.  $V_{IN} = 12V$ ,  $V_{OUT1} = 1V$ ,  $V_{OUT2} = 3.3V$ ,  $V_{OUT3} = 1.8V$ ,  $V_{OUT4} = 1.5V$ ,  $f_{SW} = 800kHz$ ,  $T_A = 25^{\circ}C$ , CCM mode, unless otherwise noted.

**Steady State**  
Full load

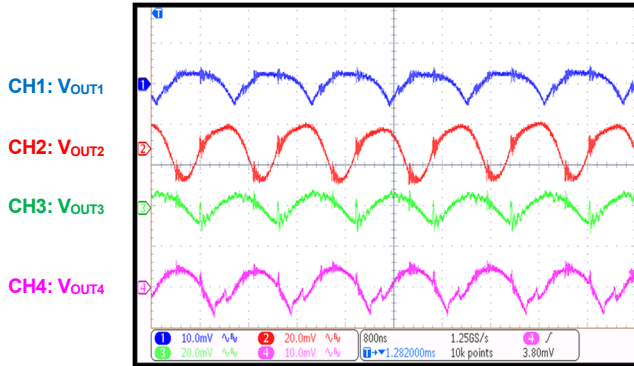

**Steady State**  
No load

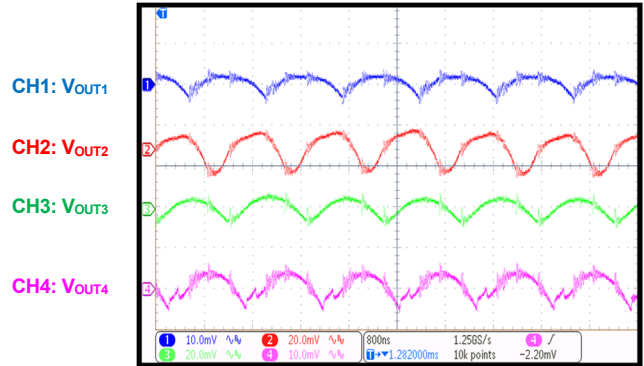

**Start-Up through EN**  
Full load

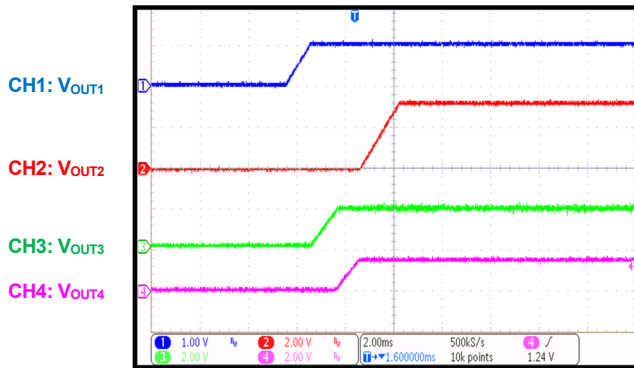

**Shutdown through EN**  
Full load

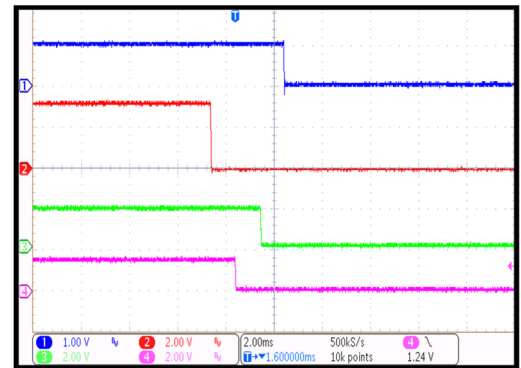

**Start-Up through EN**  
No load

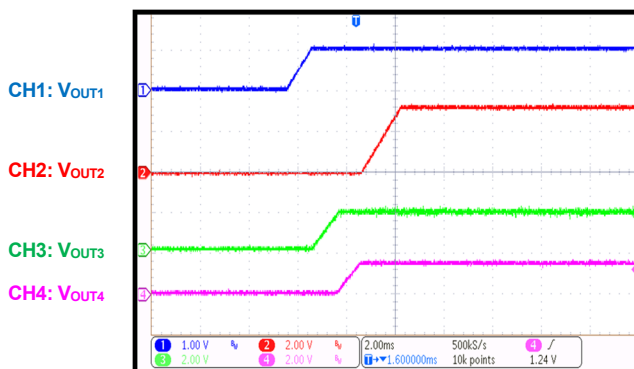

**Shutdown through EN**  
No load

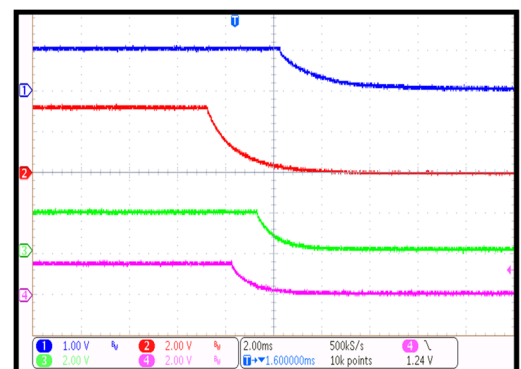

### EVB TEST RESULTS (continued)

Performance curves and waveforms are tested on the evaluation board.  $V_{IN} = 12V$ ,  $V_{OUT1} = 1V$ ,  $V_{OUT2} = 3.3V$ ,  $V_{OUT3} = 1.8V$ ,  $V_{OUT4} = 1.5V$ ,  $f_{SW} = 800kHz$ ,  $T_A = 25^{\circ}C$ , CCM mode, unless otherwise noted.

**Start-Up through VIN**  
No load

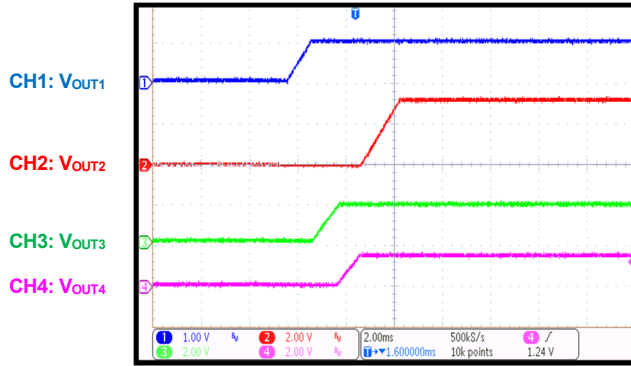

**Shutdown through VIN**  
No load

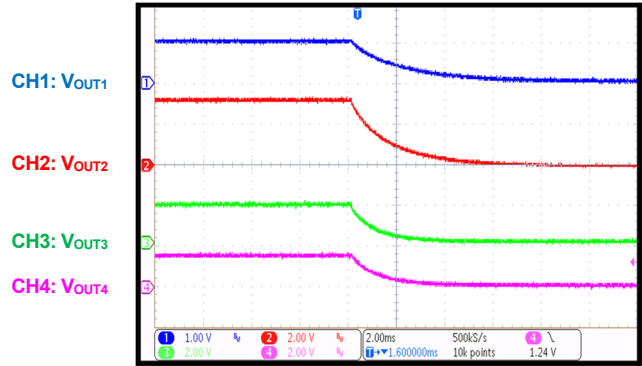

**Start-Up through VIN**  
With load

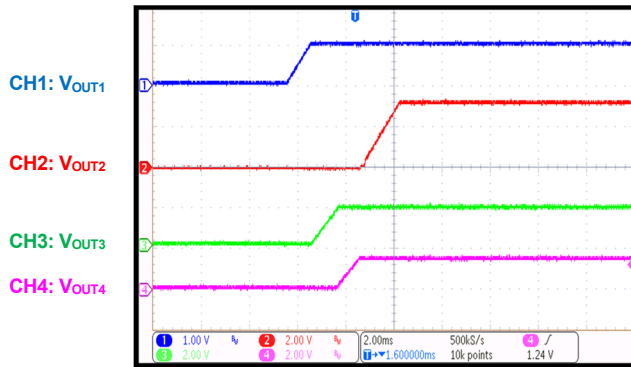

**Shutdown through VIN**  
With load

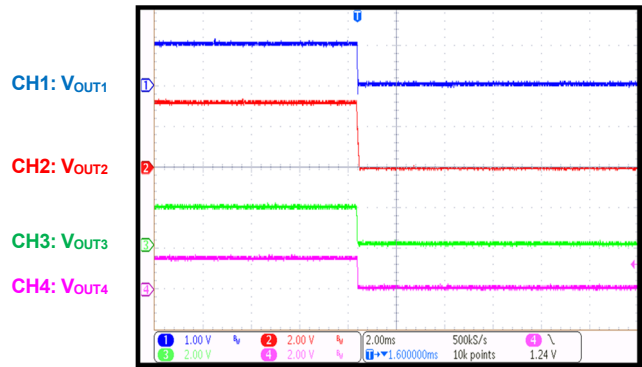

**SCP Entry**  
With load

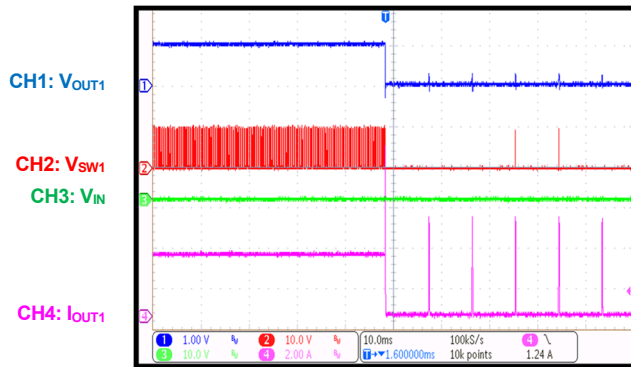

**SCP Recovery**  
Full load

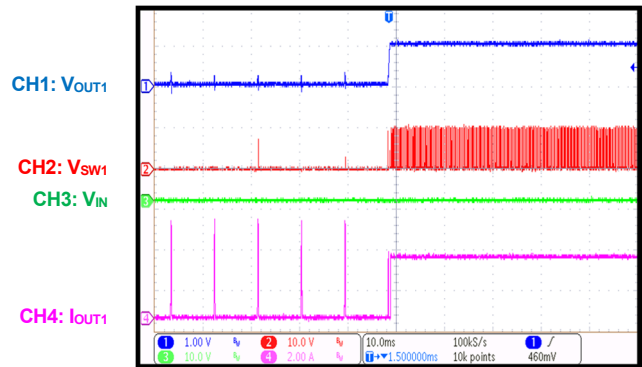



### EVB TEST RESULTS *(continued)*

Performance curves and waveforms are tested on the evaluation board.  $V_{IN} = 12V$ ,  $V_{OUT1} = 1V$ ,  $V_{OUT2} = 3.3V$ ,  $V_{OUT3} = 1.8V$ ,  $V_{OUT4} = 1.5V$ ,  $f_{SW} = 800kHz$ ,  $T_A = 25^{\circ}C$ , CCM mode, unless otherwise noted.

**Load Transient**  
0A to 1.5A

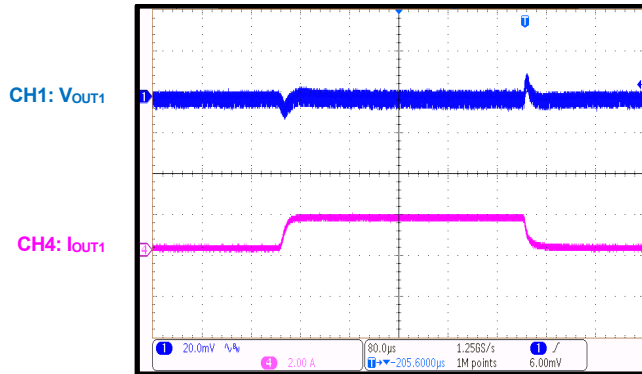

**Load Transient**  
0A to 1.5A

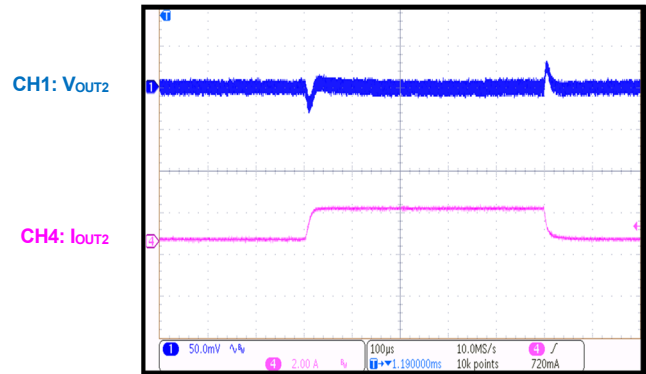

**Load Transient**  
1.5A to 3A

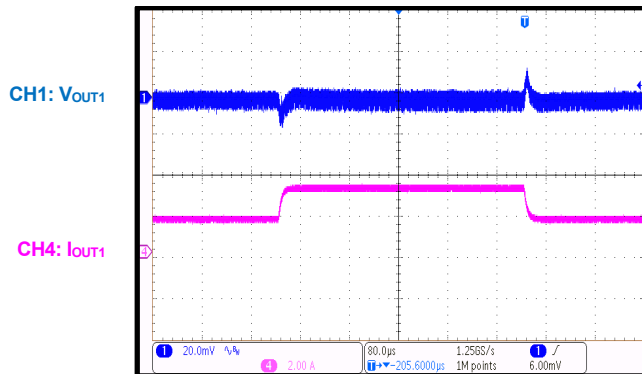

**Load Transient**  
1.5A to 3A

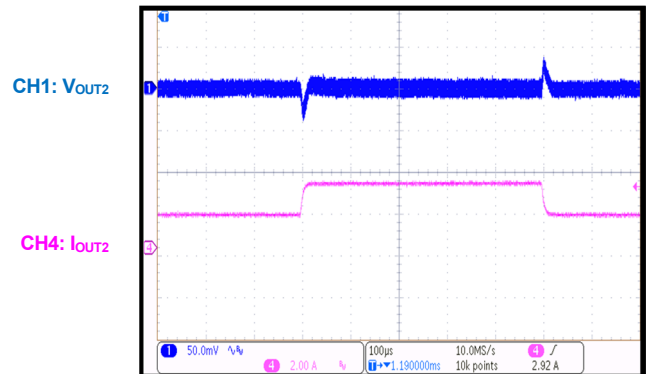

**Load Transient**  
0A to 1A

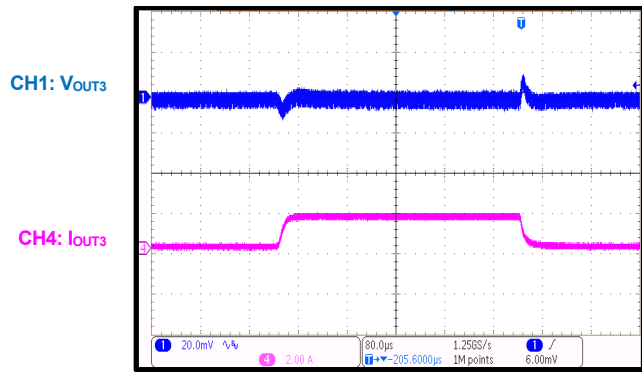

**Load Transient**  
0A to 1A

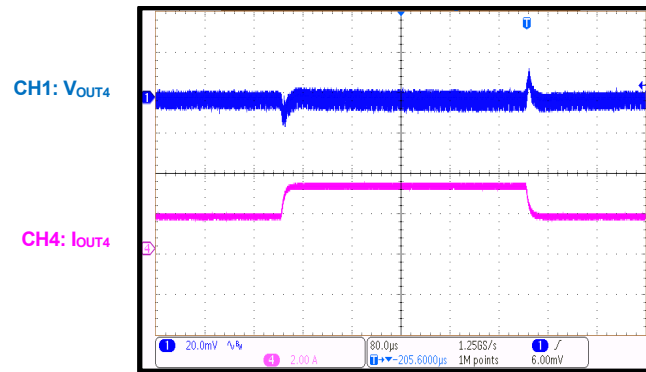

### EVB TEST RESULTS *(continued)*

Performance curves and waveforms are tested on the evaluation board.  $V_{IN} = 12V$ ,  $V_{OUT1} = 1V$ ,  $V_{OUT2} = 3.3V$ ,  $V_{OUT3} = 1.8V$ ,  $V_{OUT4} = 1.5V$ ,  $f_{SW} = 800kHz$ ,  $T_A = 25^{\circ}C$ , CCM mode, unless otherwise noted.

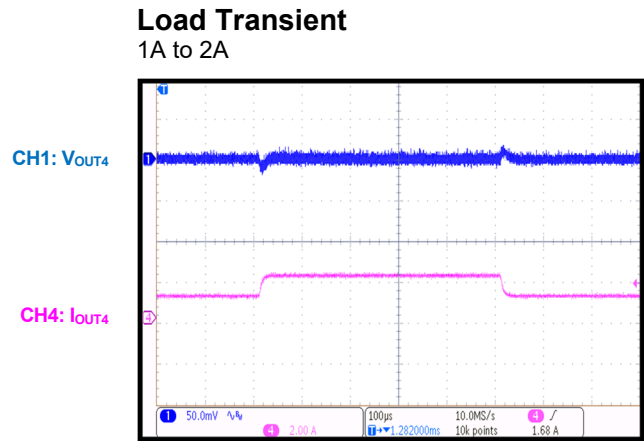
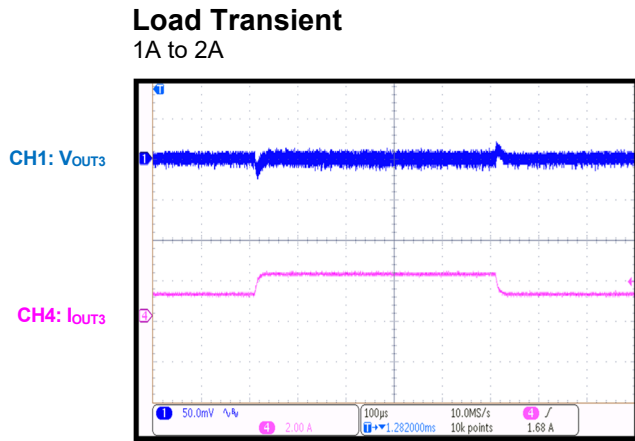

### PCB LAYOUT

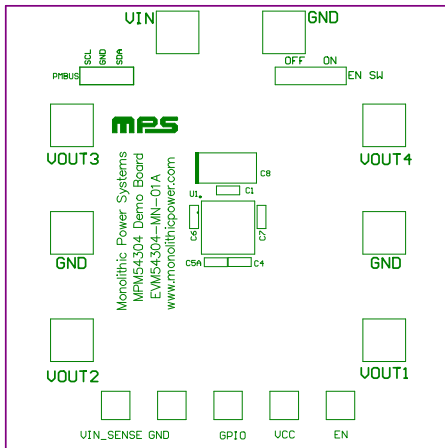

Figure 2: Top Silk

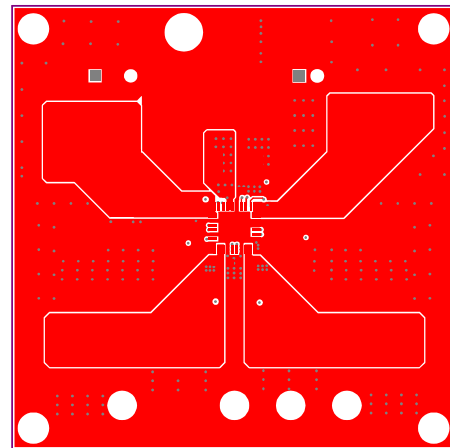

Figure 3: Top Layer

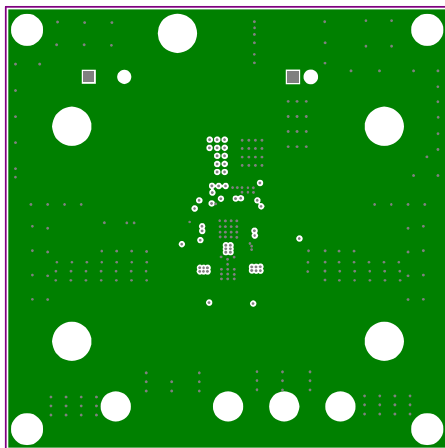

Figure 4: Mid-Layer 1

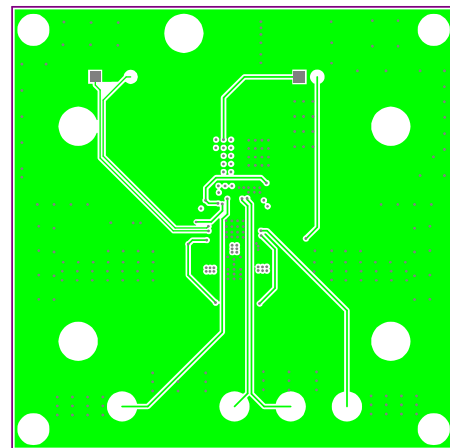

Figure 5: Mid-Layer 2

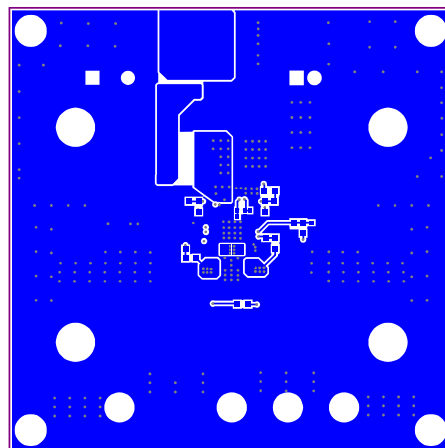

Figure 6: Bottom Layer

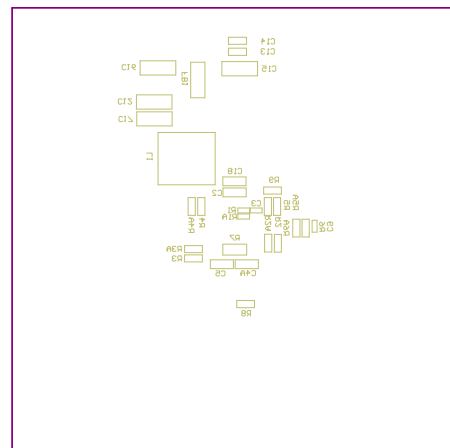

Figure 7: Bottom Silk



## REVISION HISTORY

Revision #	Revision Date	Description	Pages Updated
1.0	3/12/2021	Initial Release	-

**Notice:** The information in this document is subject to change without notice. Please contact MPS for current specifications. Users should warrant and guarantee that third-party Intellectual Property rights are not infringed upon when integrating MPS products into any application. MPS will not assume any legal responsibility for any said applications.