

Using the UCC28950EVM-442

User's Guide



Literature Number: SLUU421A
May 2010—Revised May 2010

600-W, Phase-Shifted, Full-Bridge Converter

1 Introduction

This 600-W EVM was designed to demonstrate how the UCC28950 control device could be used in high-efficiency applications by achieving ZVS from 50% to 100% load. To achieve this high efficiency the UCC28950 was designed to drive synchronous rectifiers on the secondary side of the full bridge converter. The UCC28950 also incorporates a burst mode and DCM function to improve no-load efficiency. Please see UCC28950 data sheet for details ([TI Literature Number SLUSA16](#)).

The DCM (Discontinuous Current Mode) comparator was designed to turn off the synchronous rectifiers before the output current reaches critical conduction at lighter loads (< 20%). This does two things. First it removes the energy that is required to drive the FETs at lighter loads. Second the DCM feature prevents the output inductor from developing a negative current that can damage the output synchronous rectifiers under no load/transient conditions.

2 Description

The UCC28950EVM is a 600-W phase-shifted full-bridge converter that converts a 370 V to 410-V DC input to a regulated 12-V output. This converter was designed to maintain ZVS down to 50% load.

3 Typical Applications

- Server, Telecom Power Supplies
- Industrial Power Systems
- High-Density Power Architectures

4 Features

- ZVS from 50% to 100% load
- Higher Efficiency for 80 + Applications
- Burst Mode/DCM Function to Reduce No-Load Power Dissipation to Meet Green-Mode Requirements

5 Electrical Performance Specifications

Table 1. UCC28950EVM-442 Electrical Specifications⁽¹⁾

PARAMETER	TEST CONDITIONS	MIN	TYP	MAX	UNITS
Input Characteristics					
DC input voltage range		370	390	410	V
Maximum input current	$V_{IN} = 370 V_{DC}$ to $410 V_{DC}$			2	A
Output Characteristics					
Output voltage (V_{OUT})	$V_{IN} = 370 V_{DC}$ to $410 V_{DC}$	11.4	12	12.6	V
Output current (I_{OUT})	$V_{IN} = 370 V_{DC}$ to $410 V_{DC}$			50	A
Continuous output power (P_{OUT})	$V_{IN} = 370 V_{DC}$ to $410 V_{DC}$			600	W
Load regulation	$V_{IN} = 370 V_{DC}$ to $410 V_{DC}$, $I_{OUT} = 5 A$ to $50 A$			150	mV
Line regulation	$V_{IN} = 370 V_{DC}$ to $410 V_{DC}$, $I_{OUT} = 5 A$ to $50 A$			150	
Output ripple voltage	$V_{IN} = 370 V_{DC}$ to $410 V_{DC}$, $I_{OUT} = 5 A$ to $50 A$			200	
System					
Full load efficiency	$V_{IN} 370 V$ to $390 V$, $P_{OUT} = 500 W$	93%	94%		

⁽¹⁾ Operation ambient temperature full load, forced air cooling LFM 25°C.

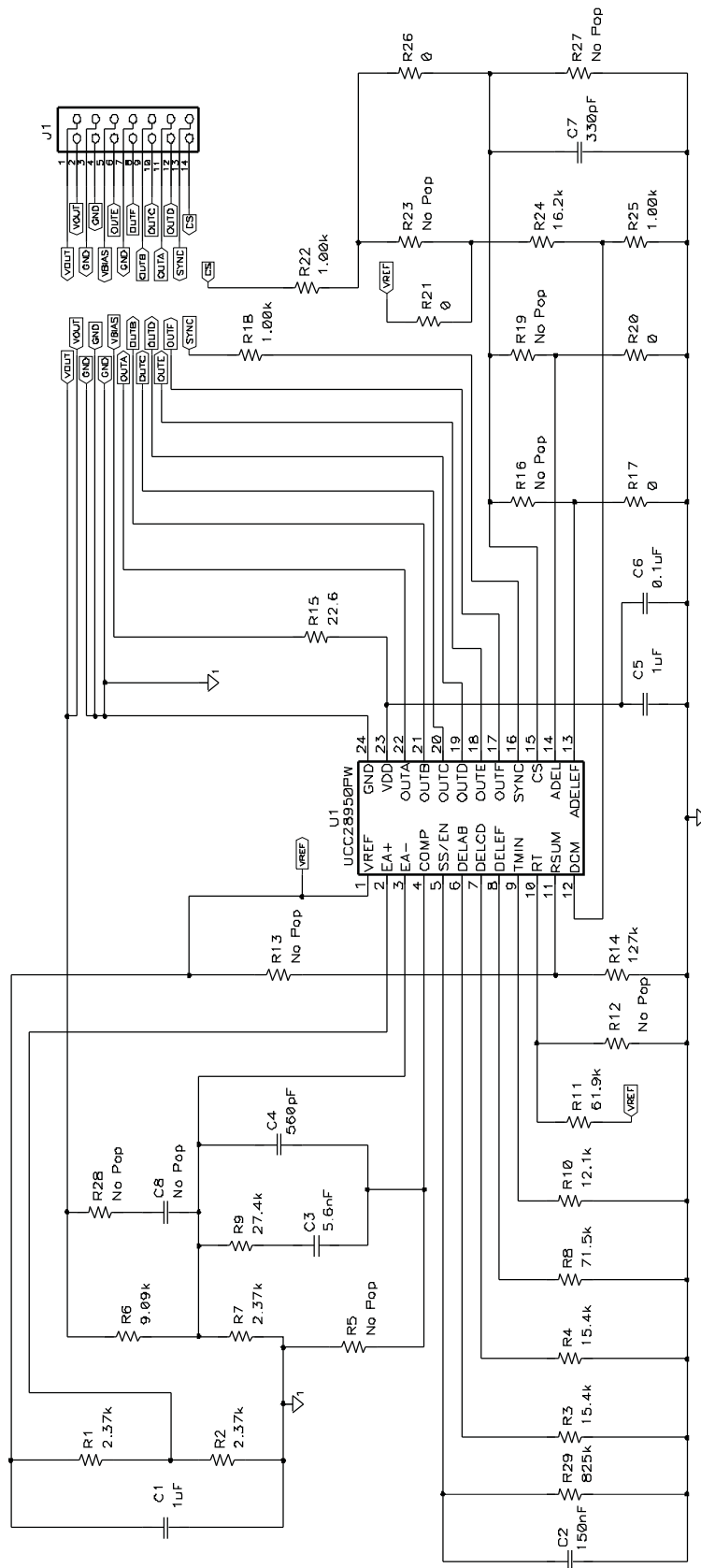

Figure 2. UCC28950EVM-442 Daughter Card Controller Schematic

6 Recommended Test Equipment

6.1 Differential Probe

- Capable of measuring 500 V

6.2 Voltage Sources

- 500-V DC source capable of 750 W
- 0-V to 20-V DC power supply

6.3 Volt Meters

- 4-V meters

6.4 Network Analyzer

- Needed to measure voltage loop stability

6.5 Output Load

25-V/750-W load

6.6 Oscilloscope

- 4 Channel 100 MHz
- Probes capable of 500 V or differential probes

6.7 Precision Shunt Resistors

- $R_{\text{SHUNT1}} = 5 \text{ A}/100 \text{ mV}$
- $R_{\text{SHUNT2}} = 50 \text{ A}/50 \text{ mV}$

6.8 Fan

- 400 LFM

6.9 Recommended Wire Gauge

- 18 AWG at VIN +, VIN – to source
- 8 AWG at VOUT +, VOUT – to electronic/ resistive loads

7 Recommended Test Setup

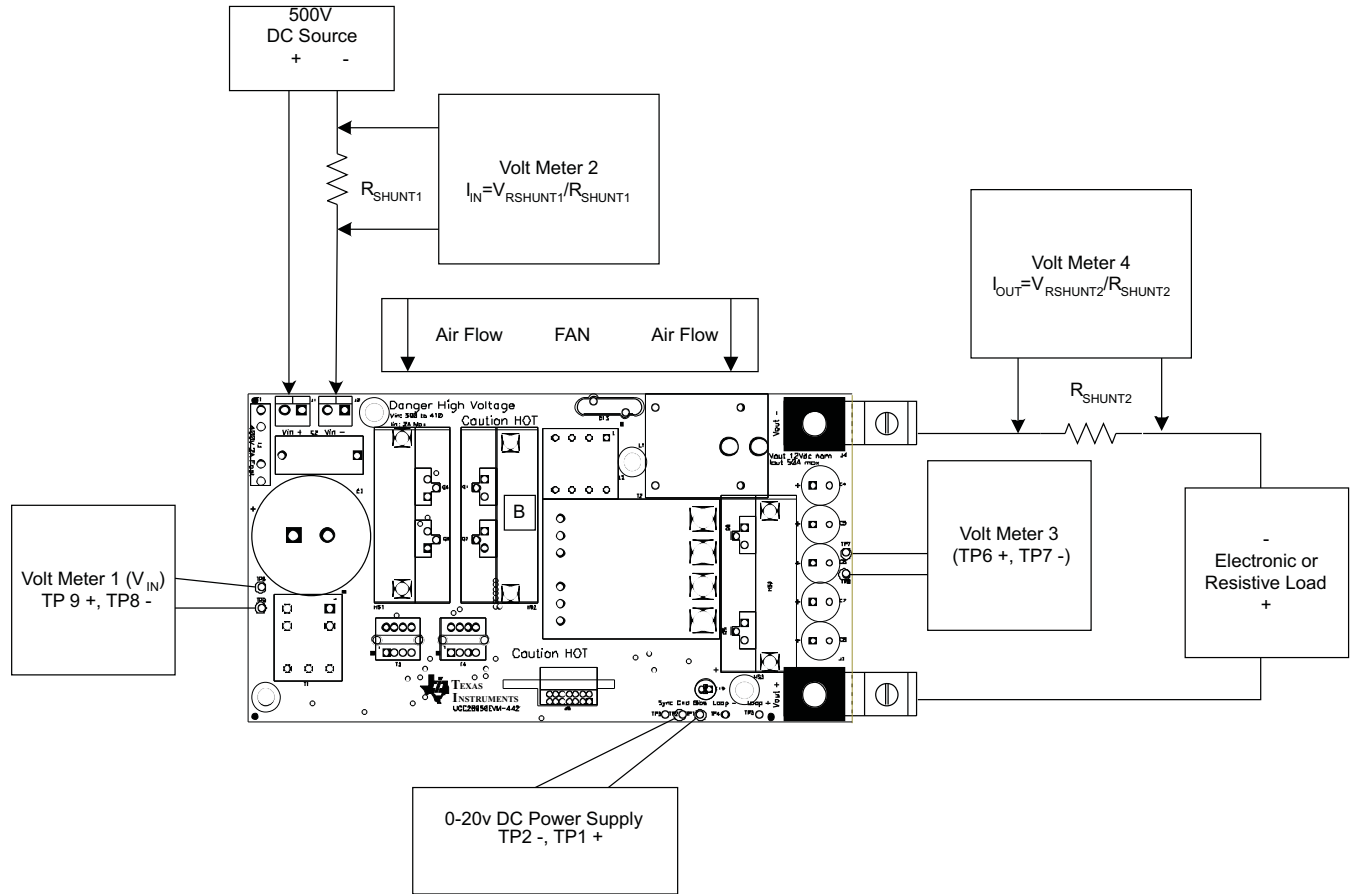

Figure 3. Test Setup to Measure Efficiency

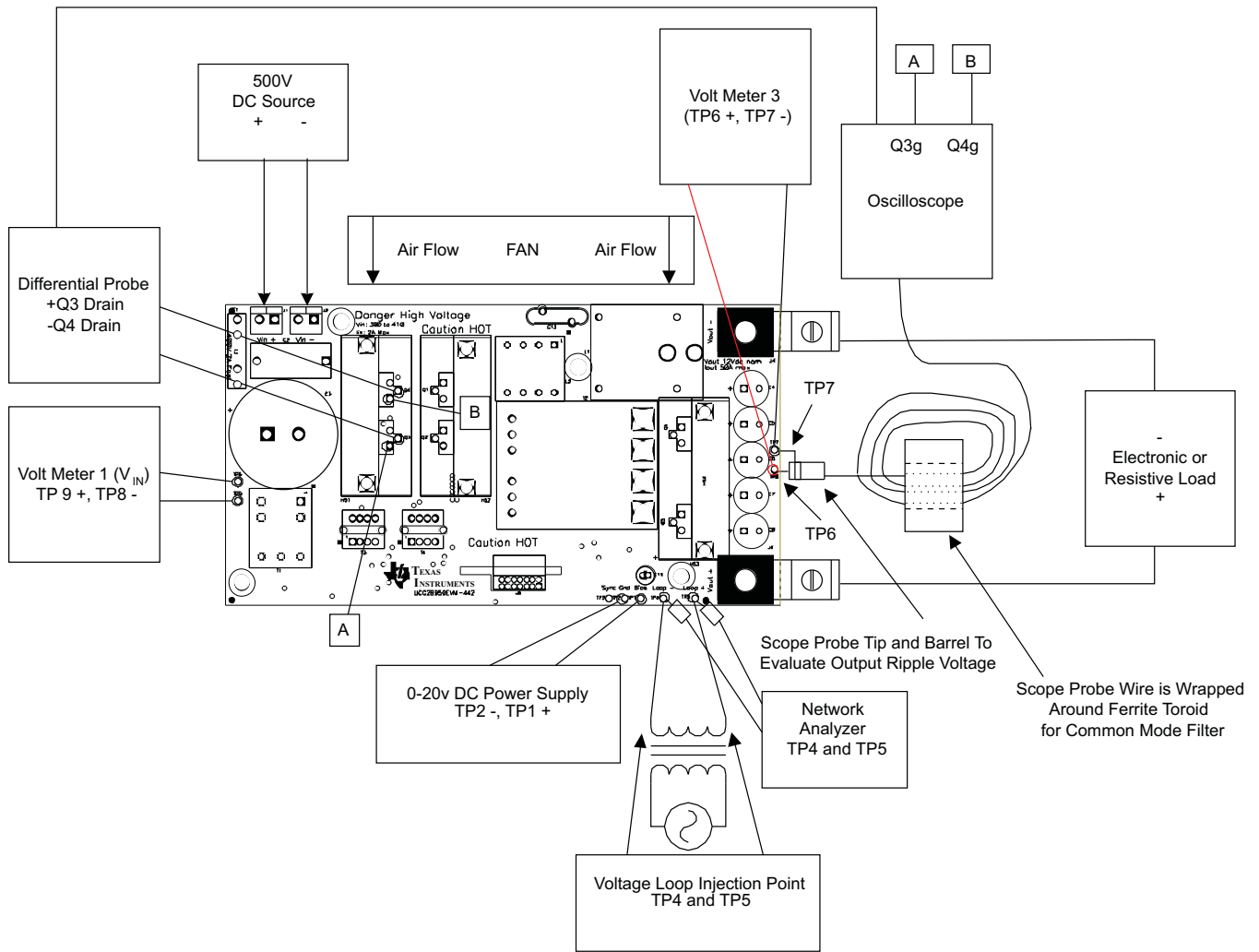

Figure 4. Test Setup for Evaluating the Voltage Loop and ZVS

8 Test Points

Table 2. Test Points

TEST POINTS	NAME	DESCRIPTION
TP1	BIAS	12-V bias supply
TP2	GND	Bias supply ground
TP3	SYNC	Synchronization input
TP4	N/A	Voltage loop injection point 1
TP5	N/A	Voltage loop injection point 2
TP6	N/A	VOUT +
TP7	N/A	VOUT -
TP8	N/A	VIN -
TP9	N/A	VIN +

9 Power On/Off Procedure

1. It is important to follow the power-up and power-down procedure to ensure the EVM does not get damaged
2. This EVM was designed to show the performance of the UCC28950 in a phase-shifted full bridge and is not a standalone power supply. This EVM does not include input Under Voltage Lockout (UVLO) circuitry that would be present in a standalone power supply.
3. The EVM was not designed to startup from 0-V input voltage. Please make sure the input voltage is in-between 370 V and 410 V before applying the bias voltage.
4. Connect test setup similar to [Figure 3](#) before applying power to the EVM.
5. Apply 370 V to 410 V_{DC} to the input of the power converter with the 500-V_{DC} source.
6. Set the 0-V to 20-V power supply to 12 V. (This powers the UCC28950 PWM controller)
7. When powering down the unit set the 0-V to 20-V DC supply to 0 V.
8. For safety before handling the EVM make sure there are not voltages present on the EVM greater than 50 V (volt meter 1).

10 Test Data
Table 3. Line/Load Regulation and Efficiency Test Data

SET V_{IN}	MEASURED V_{IN}	$V_{RSHUNT1}$ mV	I_{IN}	V_{OUT}	$V_{RSHUNT2}$ mV	I_{OUT}	EFFICIENCY
370	371.3	3.87	0.194	12.189	5.02	5.02	85.2%
370	371.3	5.94	0.297	12.187	8.02	8.02	88.6%
370	371.2	6.98	0.349	12.178	10.02	10.02	94.2%
370	371.1	17.14	0.857	12.145	25.04	25.04	95.6%
370	370.8	34.64	1.732	12.086	50.06	50.06	94.2%
390	390.8	3.70	0.185	12.186	5.01	5.01	84.4%
390	390.8	5.67	0.2835	12.187	8.01	8.01	88.1%
390	390.8	6.65	0.3325	12.176	10.02	10.02	93.9%
390	390.6	16.31	0.8155	12.144	25.04	25.04	95.5%
390	390.3	32.92	1.646	12.087	50.07	50.07	94.2%
410	410.0	3.56	0.178	12.185	5.02	5.02	83.8%
410	409.5	5.44	0.272	12.185	8.02	8.02	87.7%
410	409.9	6.37	0.319	12.175	10.03	10.03	93.5%
410	409.8	15.58	0.779	12.144	25.04	25.04	95.3%
410	409.5	31.41	1.571	12.086	50.07	50.07	94.1%

10.1 Efficiency and Loop Gain/Phase

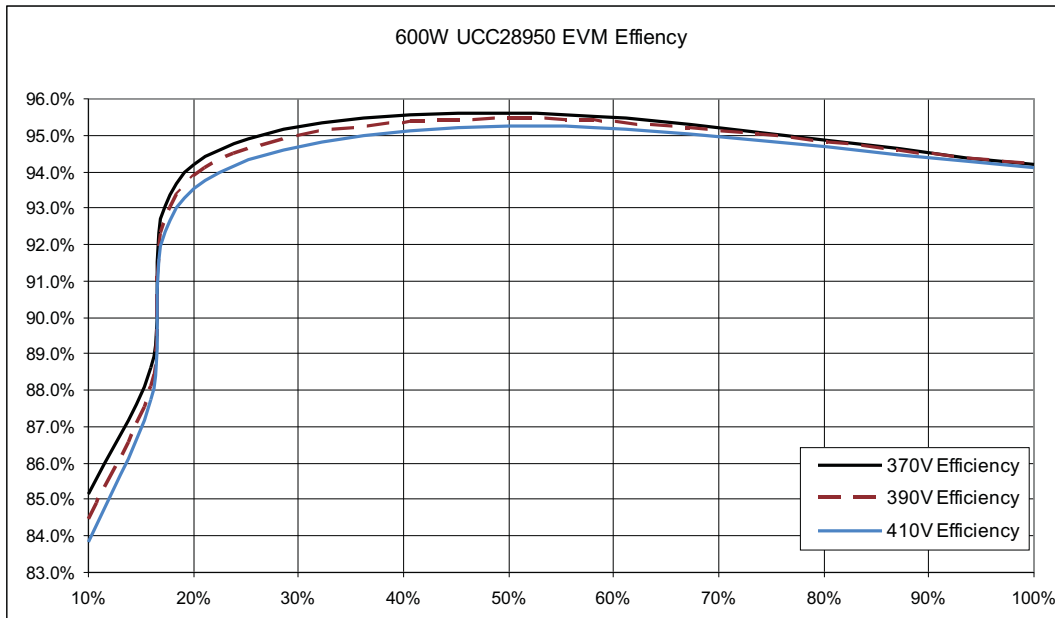

Figure 5. Efficiency 10% to 100% Load

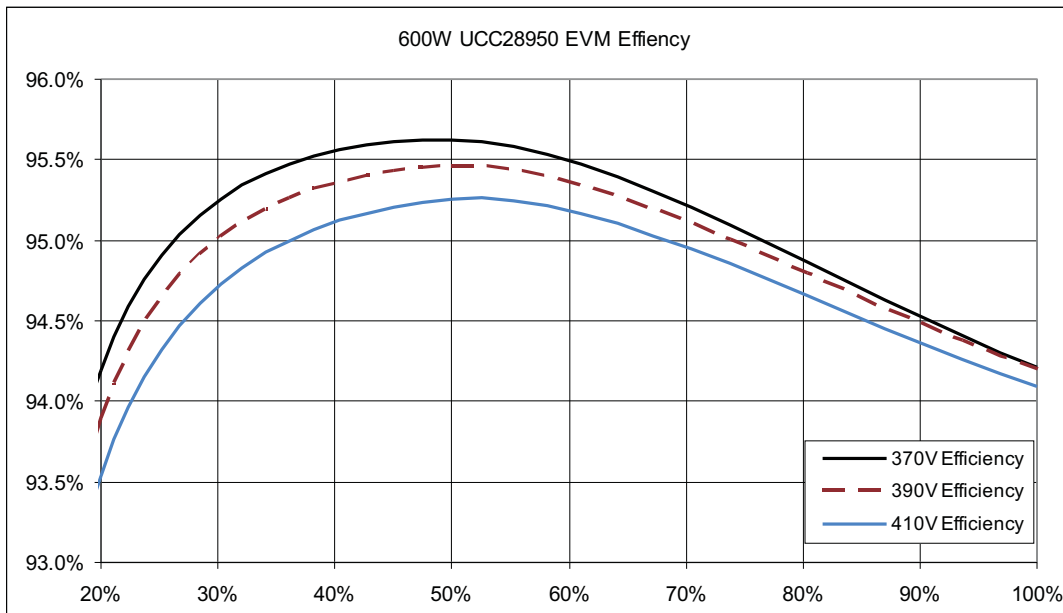

Figure 6. Efficiency 20% to 100% Load

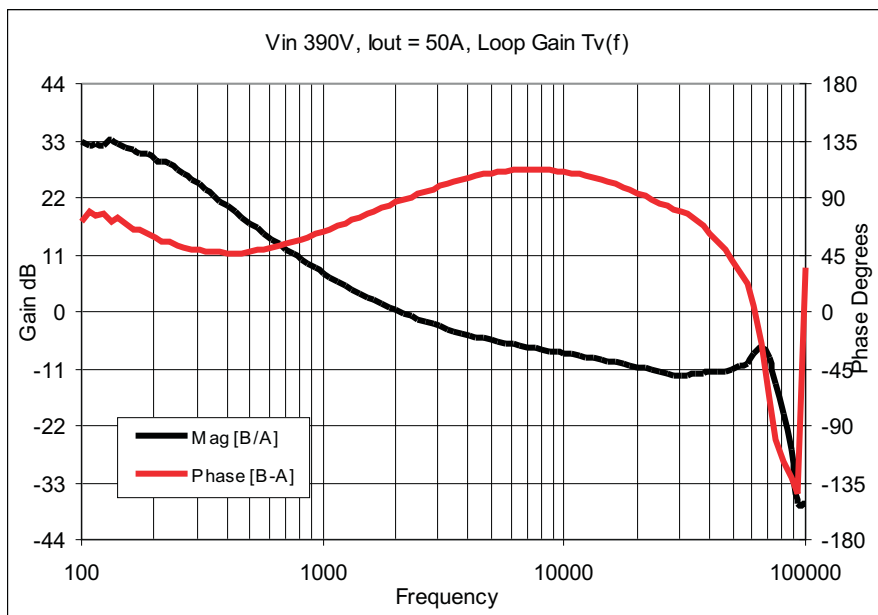

Figure 7. Loop Gain/Phase at 50 A, $f_c = 2$ kHz, PM > 90 Degrees

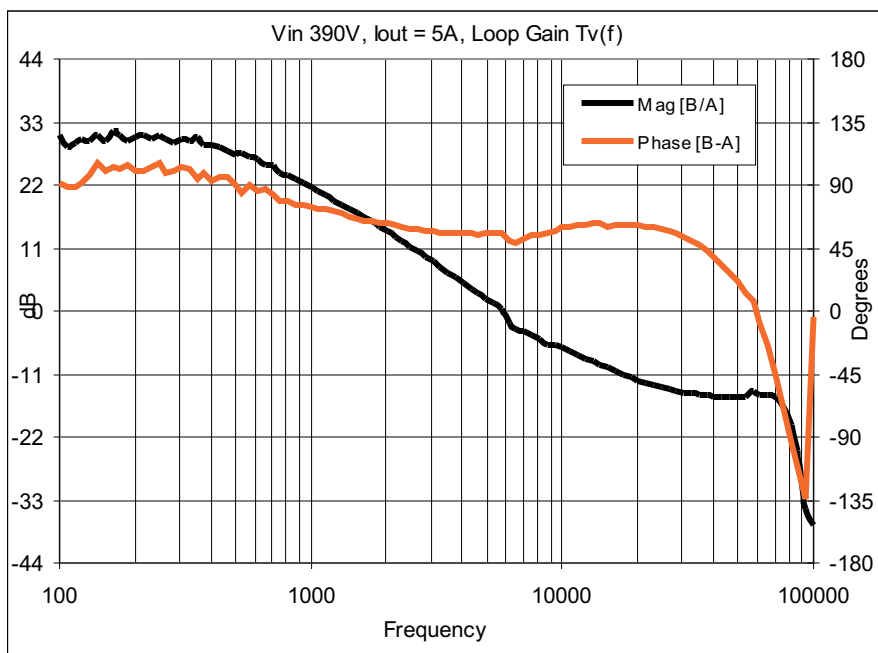

Figure 8. Loop Gain/Phase at 5 A, $f_c = 6$ kHz, PM > 45 Degrees

10.2 Transient Response

Startup CH3 = V_{OUT} .

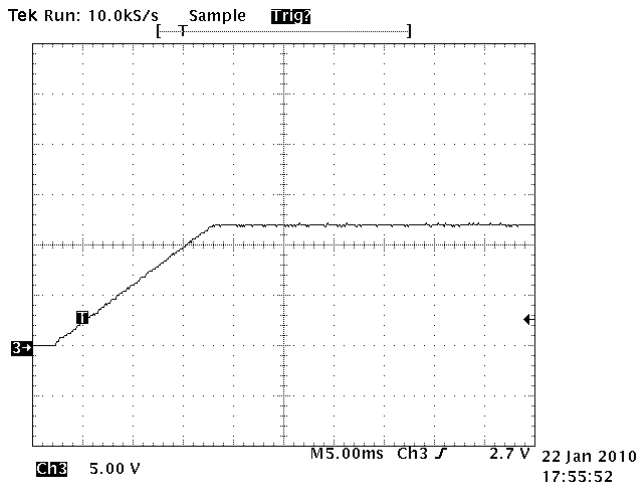

Figure 9. $V_{IN} = 390\text{ V}$, $I_{OUT} = 0\text{ A}$

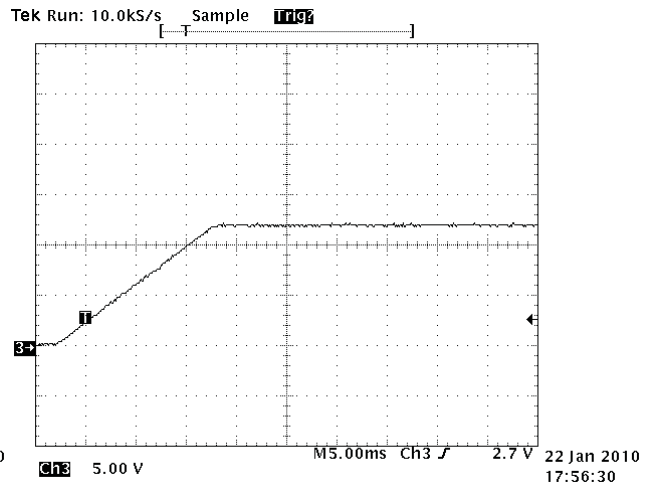

Figure 10. $V_{IN} = 390\text{ V}$, $I_{OUT} = 5\text{ A}$

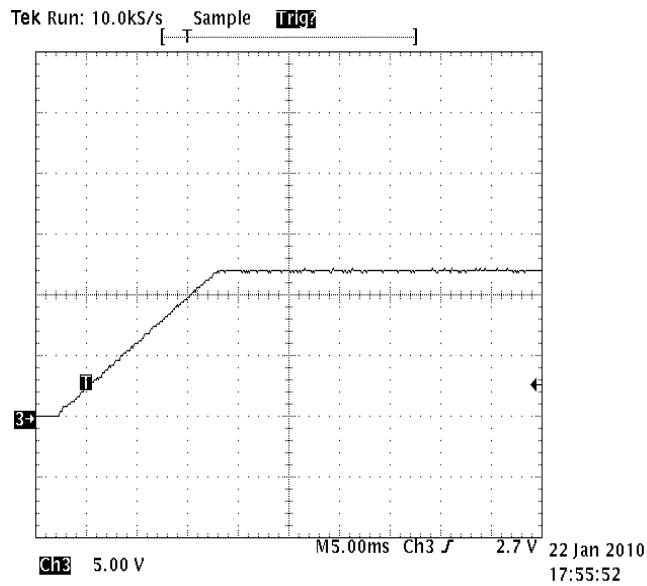

Figure 11. $V_{IN} = 390\text{ V}$, $I_{OUT} = 50\text{ A}$

10.3 2. Load Transient Response

CH4 = I_{OUT} , CH3 = V_{OUT} with 10-V DC offset.

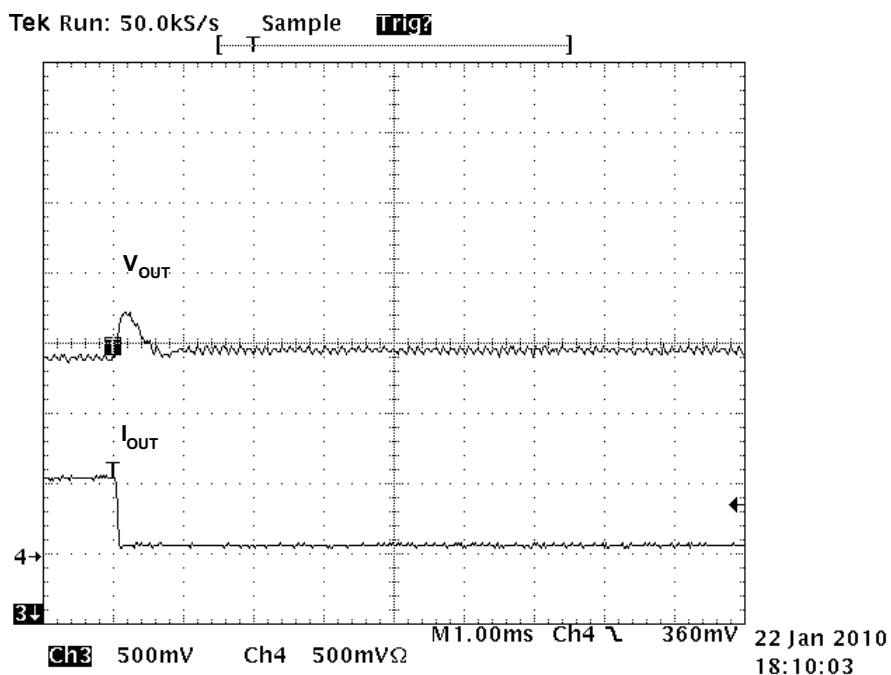

Figure 12. $V_{IN} = 390\text{ V}$, $I_{OUT} = 5\text{ A to } 50\text{ A}$

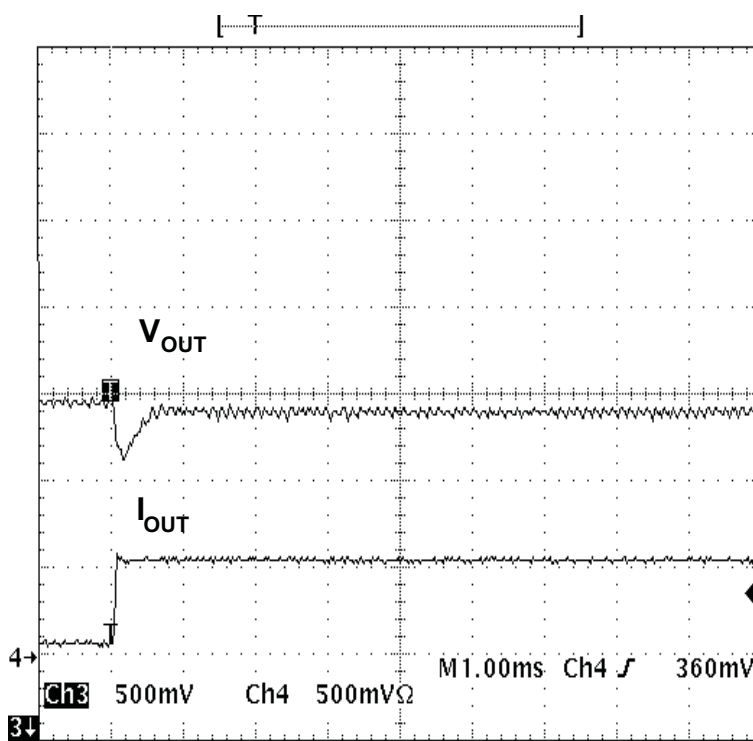

Figure 13. $V_{IN} = 390\text{ V}$, $I_{OUT} = \text{stepped from } 5\text{ A to } 50\text{ A}$

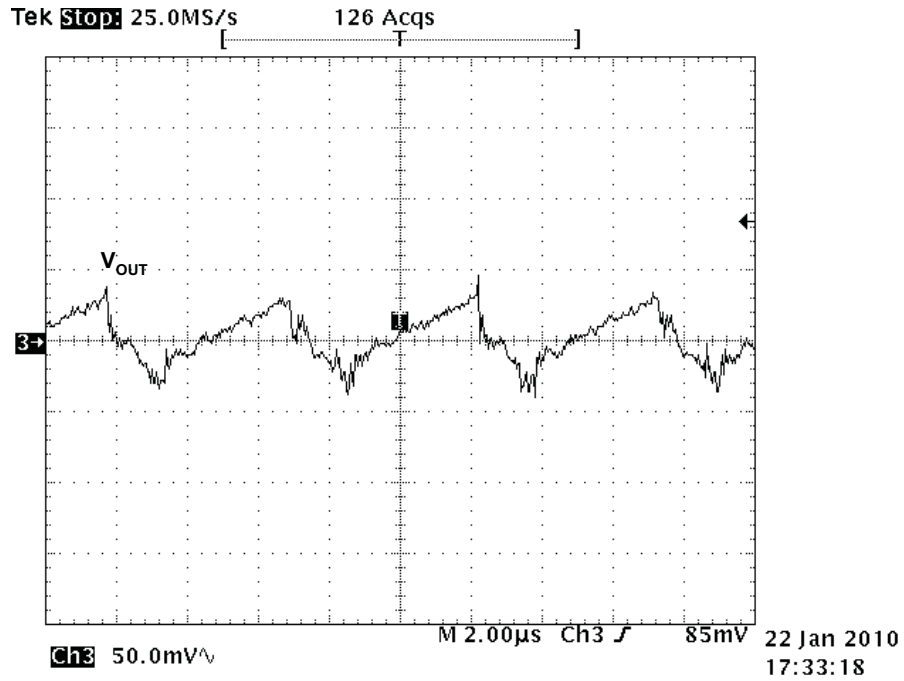

Figure 14. $V_{IN} = 390\text{ V}$, $I_{OUT} = 50\text{ A}$

10.4 Valley Switching

1. At loads lower than 25 A the switch nodes valley switch
2. CH1 = differential probe $+(Q3_d)$ and $-(Q4_d)$, 200:1, CH3 = $Q3_g$, CH2 = $Q4_g$.

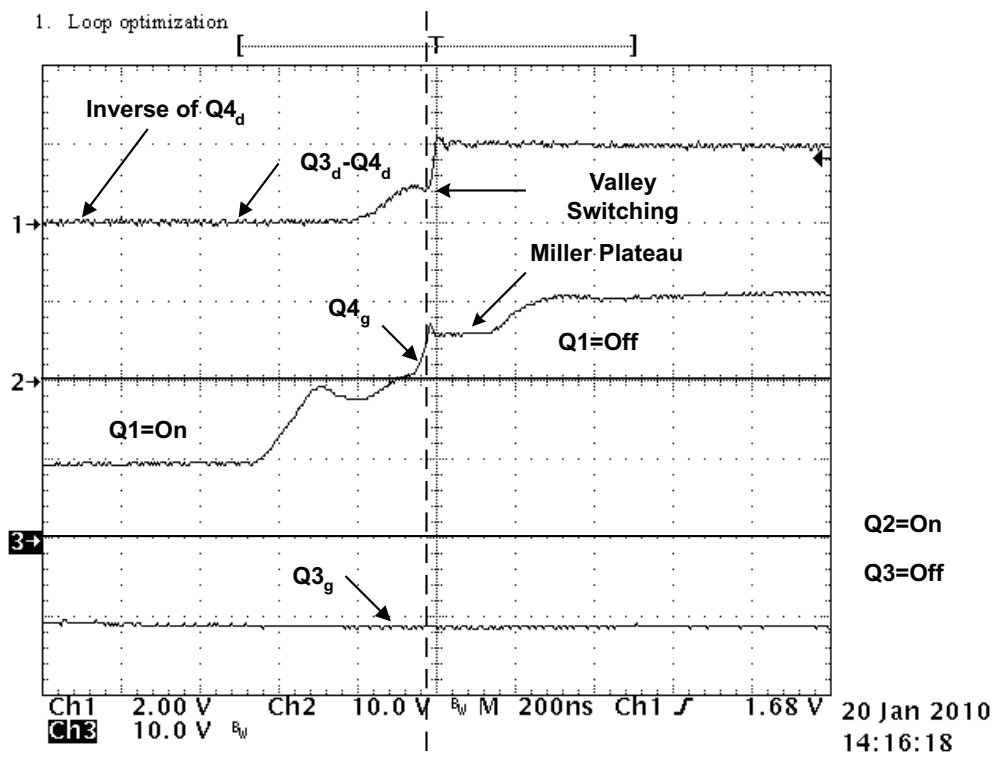

Figure 15. $V_{IN} = 390\text{ V}$, $I_{OUT} = 5\text{ A}$

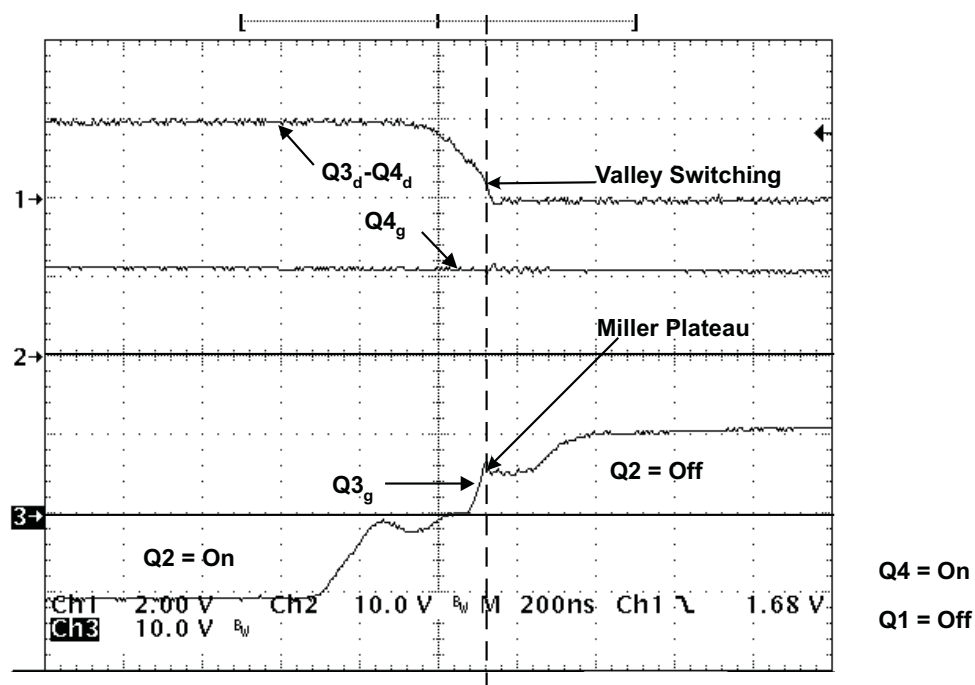

Figure 16. $V_{IN} = 390\text{ V}$, $I_{OUT} = 5\text{ A}$

3. At loads greater than 25 A the switch nodes ZVS

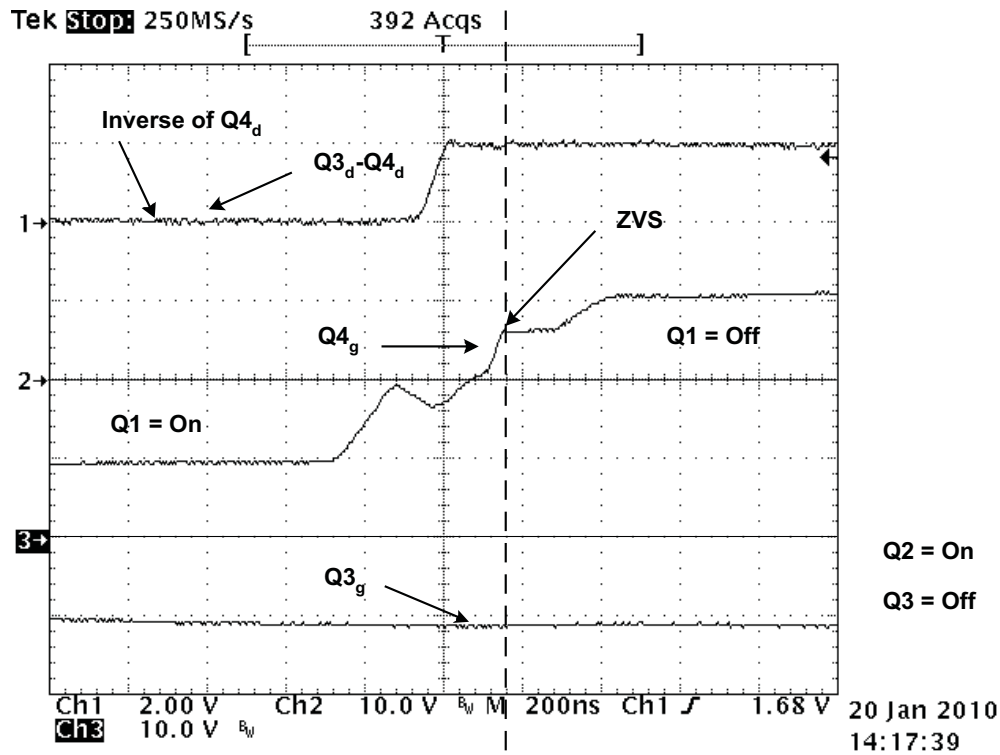

Figure 17. $V_{IN} = 390\text{ V}$, $I_{OUT} = 25\text{ A}$

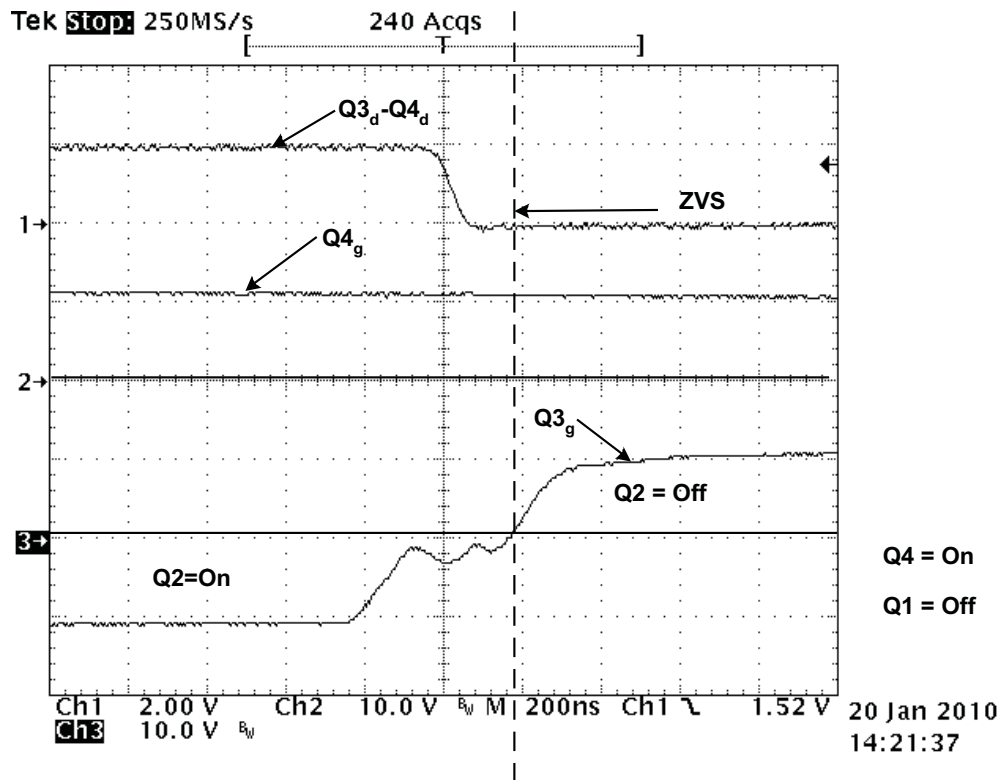

Figure 18. $V_{IN} = 390\text{ V}$, $I_{OUT} = 25\text{ A}$

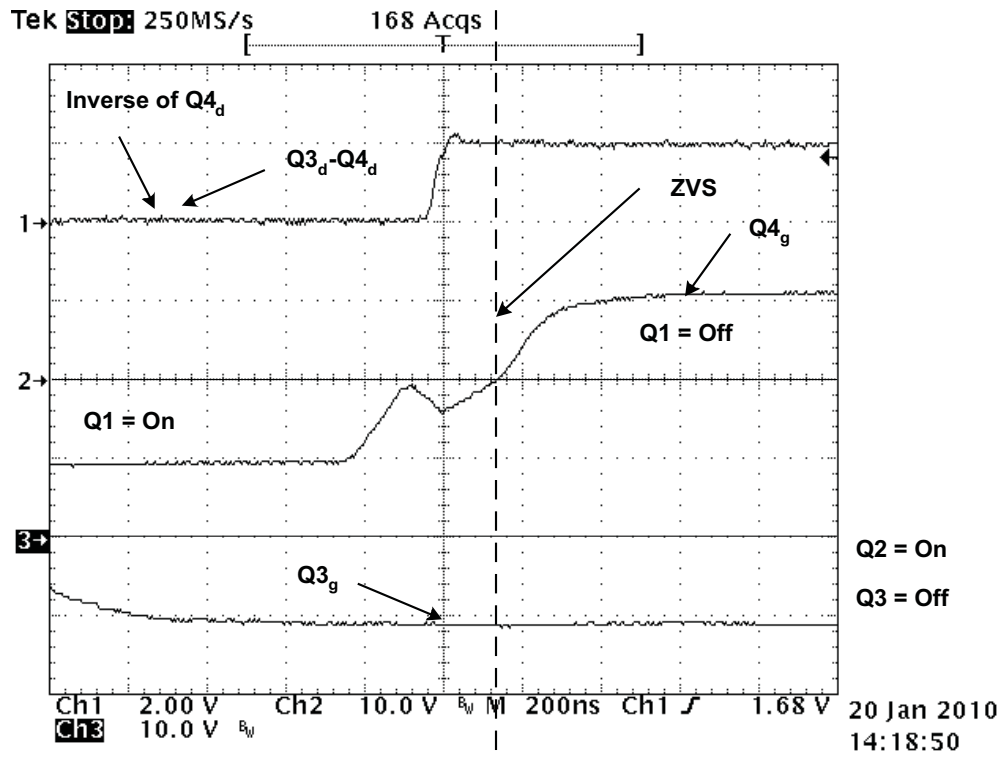

Figure 19. $V_{IN} = 390 \text{ V}$, $I_{OUT} = 50 \text{ A}$

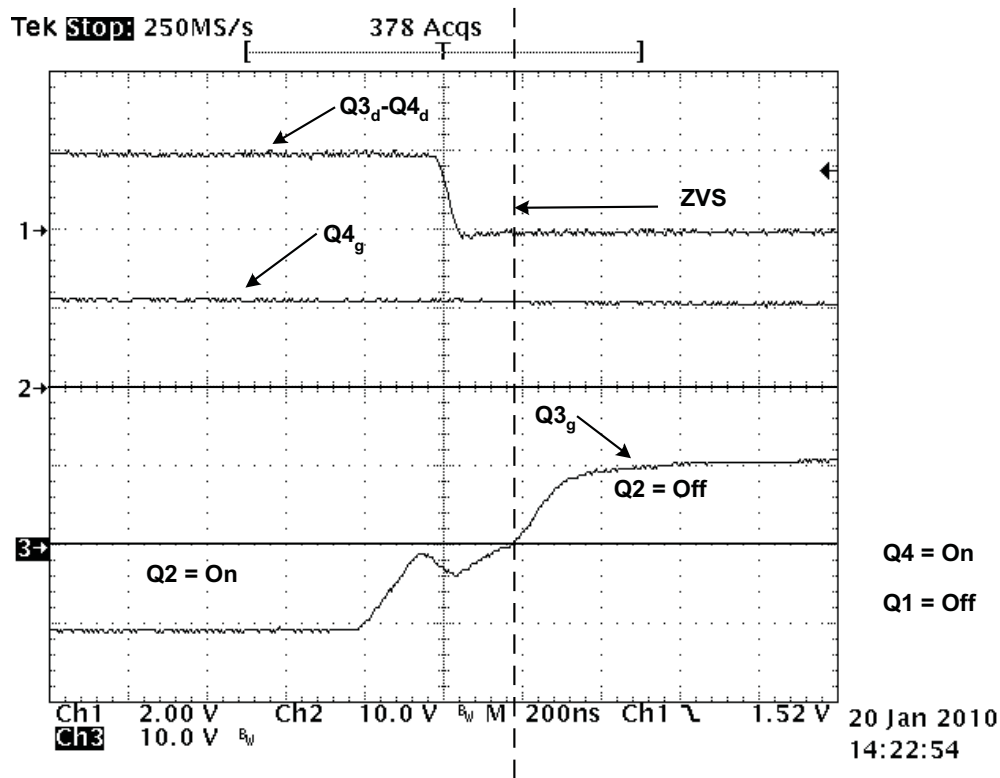

Figure 20. $V_{IN} = 390 \text{ V}$, $I_{OUT} = 50 \text{ A}$

Duty-cycle jitter is present on this EVM and it is less than 200 ns. This is because the transformer turns ratio is not exact between the primary and secondary windings of the power transformer (T2). The behavior is just peak current mode control correcting the duty cycle to ensuring the transformer properly resets after every cycle. Please refer to [Figure 21](#) and [Figure 22](#) for example of the duty-cycle jitter. CH3 = Q3 gate, CH2 = Q4 gate, CH4 = current sense signal (voltage across C7 on the daughter card controller), CH1 = T2 primary.

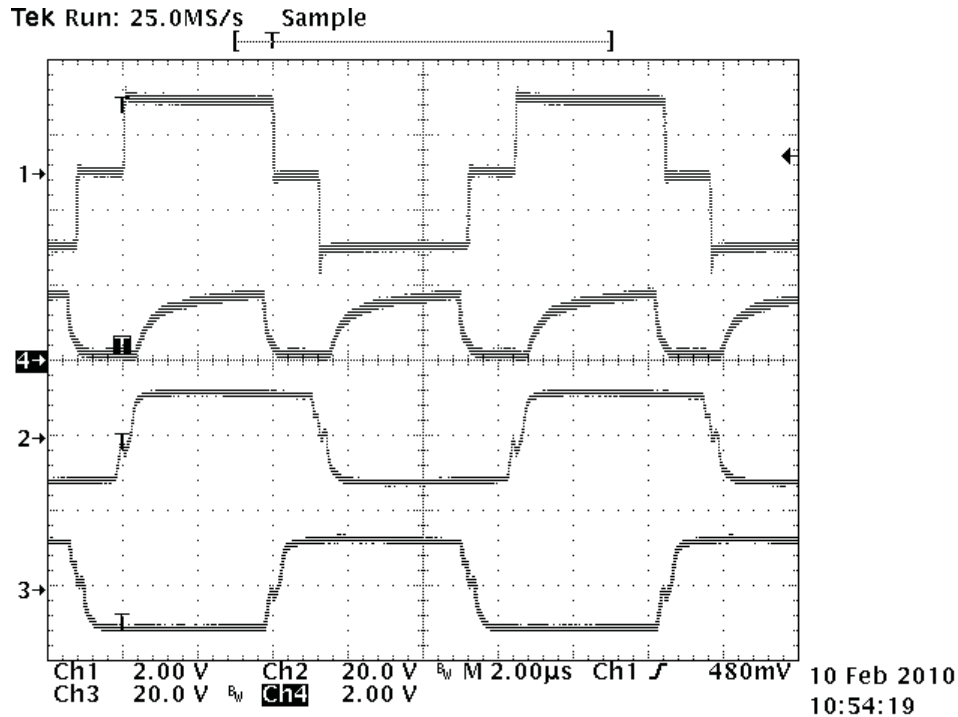

Figure 21. $V_{IN} = 390\text{ V}$, $I_{OUT} = 50\text{ A}$, 200-ns Jitter

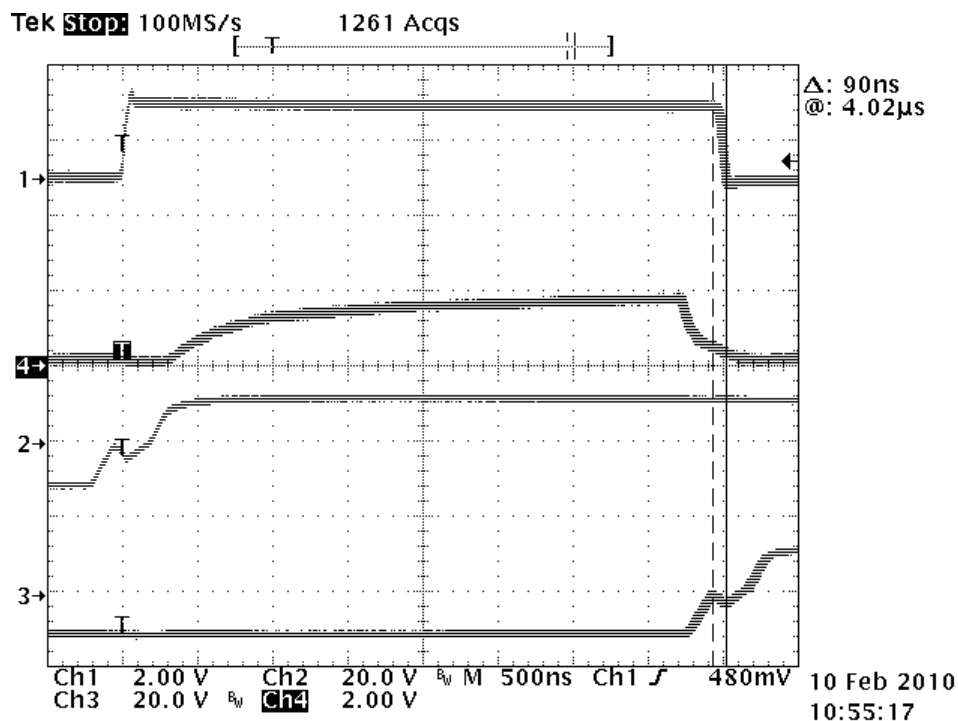

Figure 22. $V_{IN} = 390\text{ V}$, $I_{OUT} = 50\text{ A}$

The UCC28950EVM under no-load conditions will go into a burst mode to conserve energy. Please refer to the data sheet for details. Figure 23 show behavior under burst mode at $V_{IN} = 390\text{ V}$ and $I_{OUT} = 0\text{ A}$. Note that the total power consumed by the bias supply and power converter was less than 500 mW during burst mode.

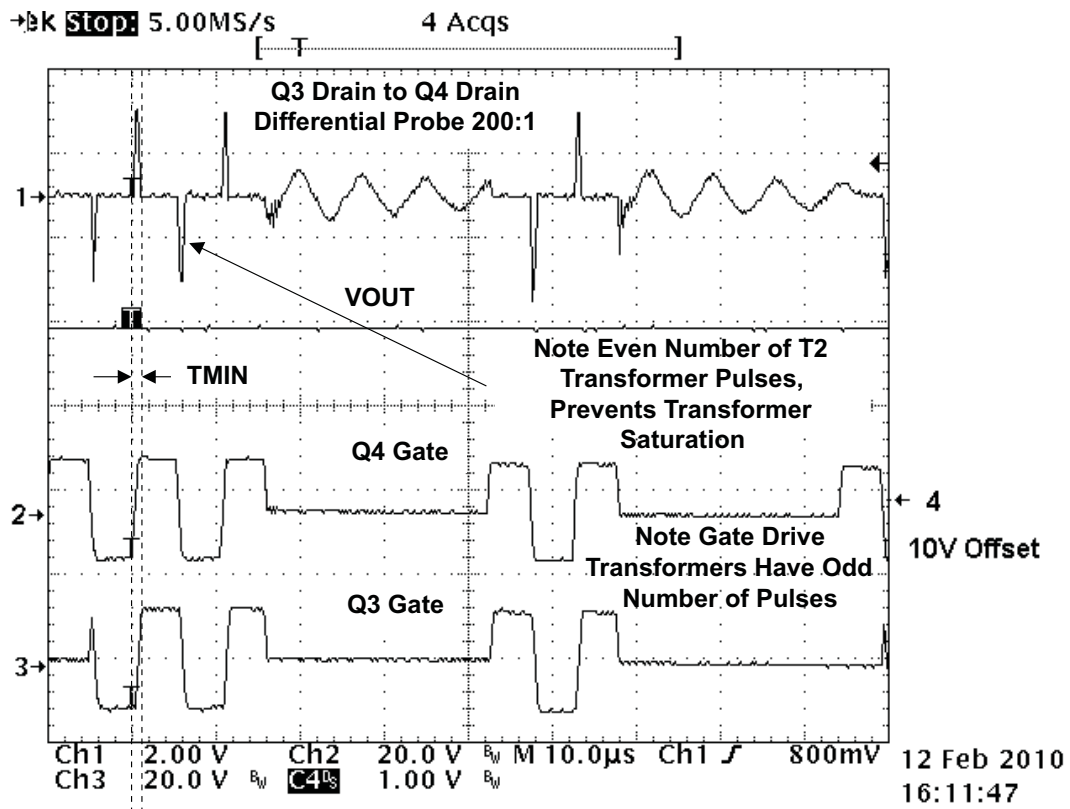

Figure 23. Burst Mode

Burst mode does cause the power supply to be slightly audible. The following plot shows voltage across the primary differentially (200:1) across Q3 Drain and Q4 drain. From this plot it can be observed that the power supply is bursting at 8.6 kHz which is in the audible range. This is very light audible noise that is lower in amplitude than the noise generated by the fan. In most cases this will not be noticed. To reduce this audible noise a designer can varnish or pot the magnetics used in the design.

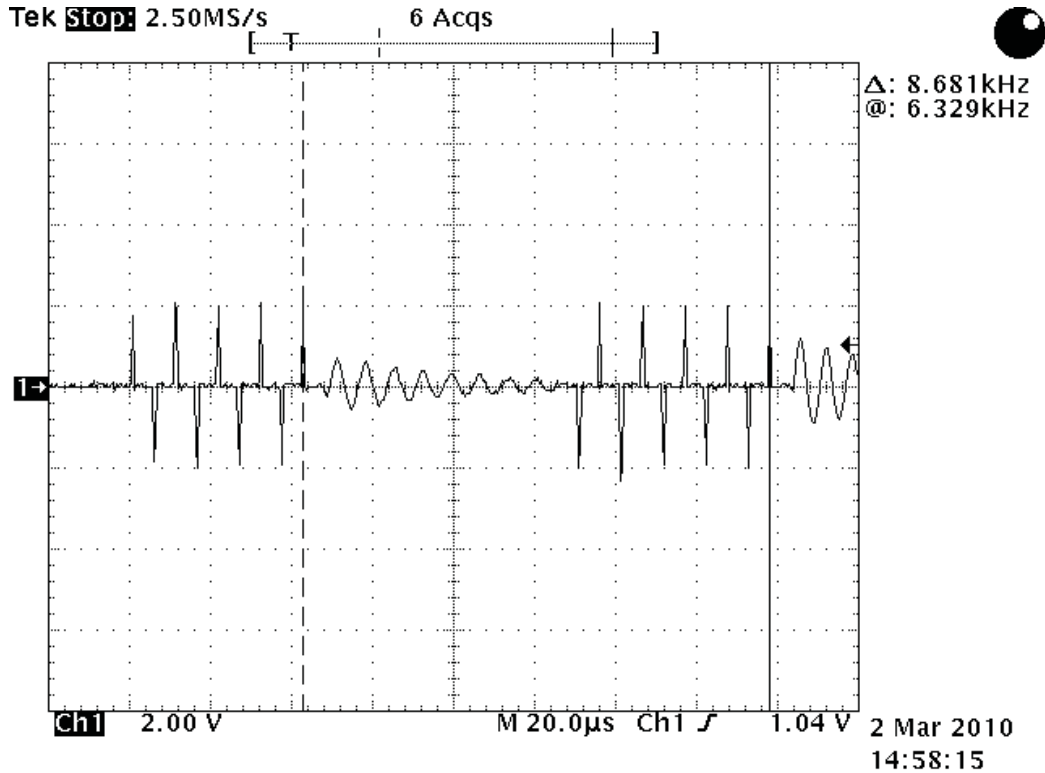

Figure 24. Burst Mode

11 Assembly Drawings and Layout

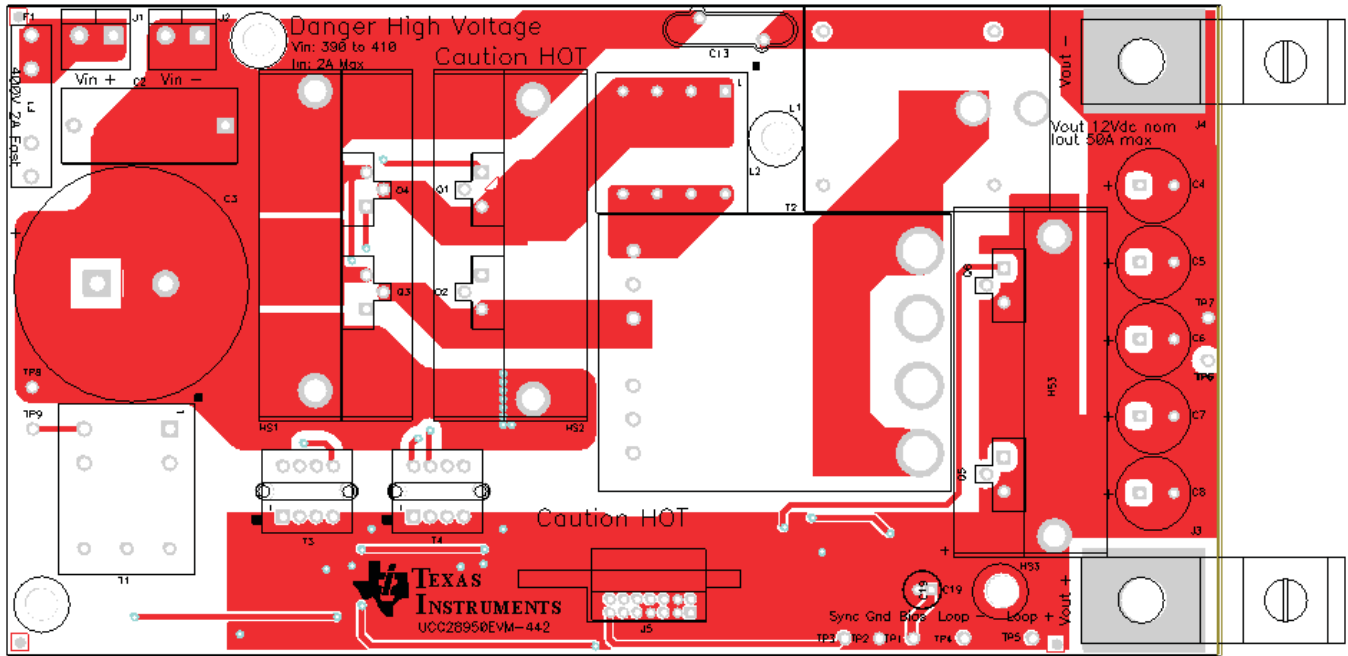

Figure 25. UCC28950EVM-442 Power Stage Top Layer Assembly Drawing (top view)

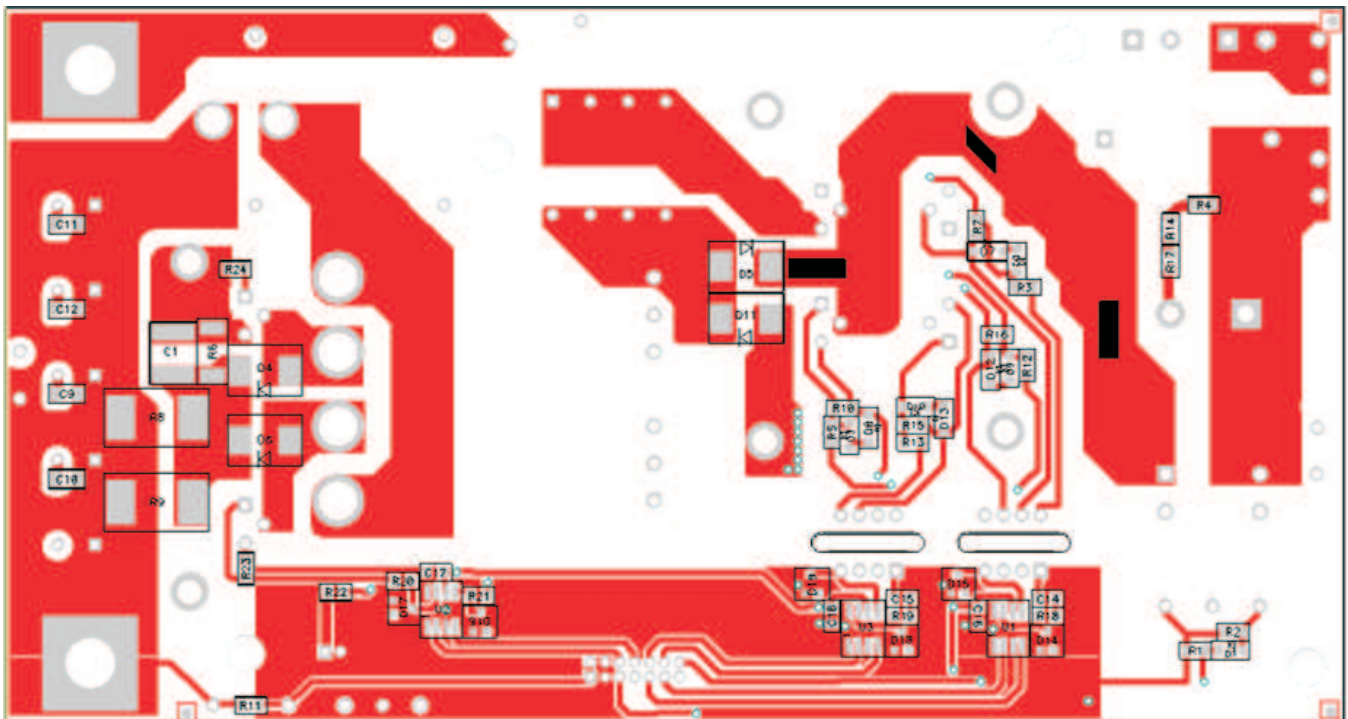

Figure 26. UCC28950EVM-442 Power Stage Bottom Layer Assembly Drawing (bottom view)

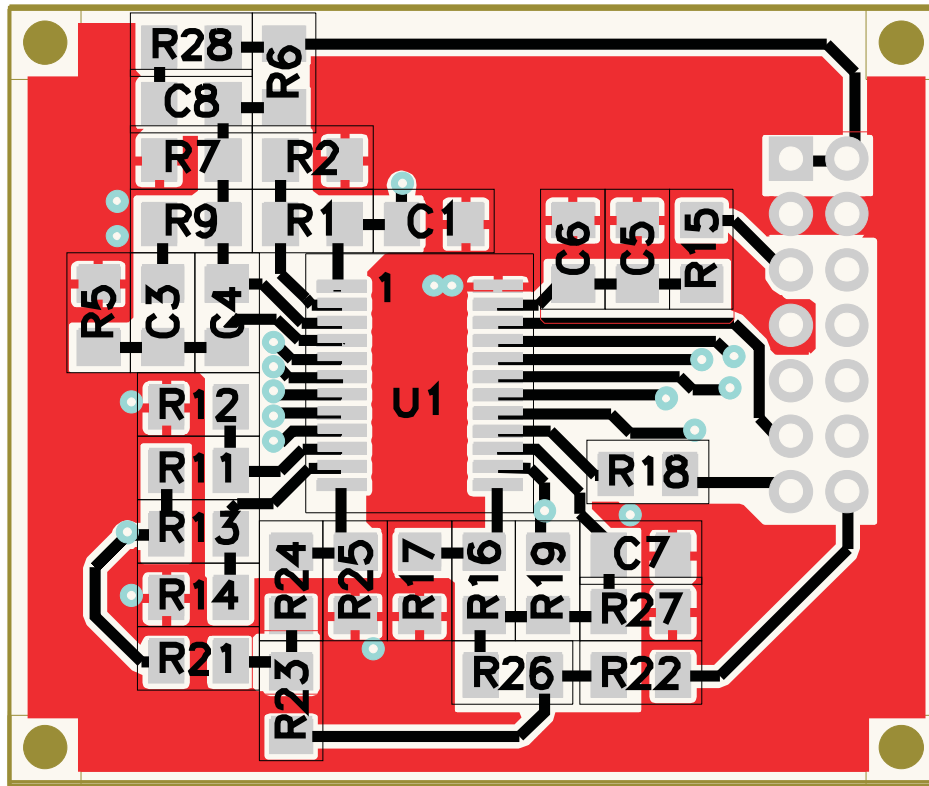

Figure 27. UCC28950EVM-442 Daughter Controller Card Top Layer Assembly Drawing (top view)

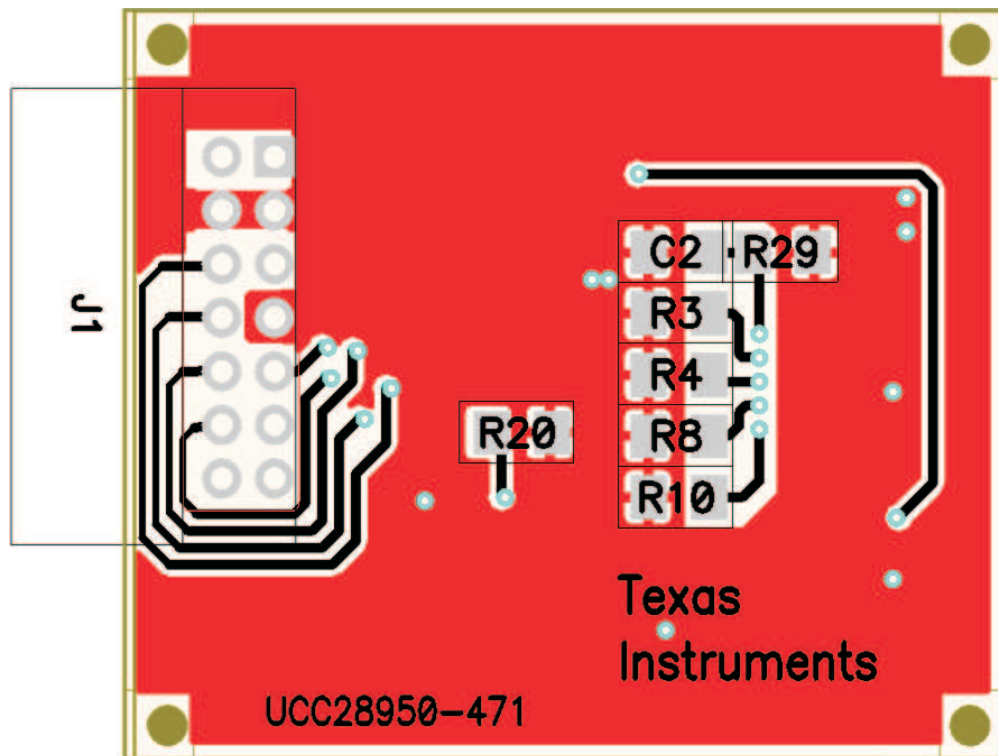

Figure 28. UCC28950EVM-442 Daughter Controller Card Bottom Layer Assembly Drawing (bottom view)

12 List of Materials

The UCC28950EVM-442 power stage components list according to the schematic in [Figure 1](#).

Table 4. UCC28950EVM-442 List of Materials

COUNT	REF DES	DESCRIPTION	PART NUMBER	MFR
1	C1	Capacitor, ceramic, 100 V X7R, 220 nF, +/- 10%, 2220	Std	Std
1	C13	Capacitor, ceramic disk, 1000 pF, 500 VAC	440LD10	Vishay-Sprague
5	C14, C15, C16, C17, C18	Capacitor, ceramic, 50 V, X7R, 1 μF, +/- 10%, 0805	Std	Std
1	C19	Capacitor, aluminum, 35 V, 22 μF, ±20%	ECA-1VM220-R	Panasonic
1	C2	Capacitor, film, 275 VAC, 0.47 μF, 20±%	ECQ-U2A474MG	Panasonic
1	C3	Capacitor, 450V, 330 μF, temp. -255 to +105°C, ±20%	EETHC2W331EA	Panasonic
5	C4, C5, C6, C7, C8	Capacitor, low impedance, 16 V, 1500 μF, ±20%	EKY-160ELL152MJ30S	Nippon
4	C9, C10, C11, C12	Capacitor, ceramic, 25 V, 1 μF, X7R, +/-10%, 1206	Std	Std
5	D1, D2, D3, D9, D10	Diode, signal, 200 mA, 100 V, 350 mW, SOD-123	1N4148W-7-F	Diodes
6	D14, D15, D16, D17, D18, D19	Diode, Schottky, 200 mA, 30 V, SOT23	BAT54	Vishay-Liteon
2	D4, D6	Diode, 3000 mA, 100 V, SMC	ES3BB	Diodes Inc
2	D5, D11	Diode, 3000 mA, 600 V, SMC	MURS360T3G	ON Semiconductor
4	D7, D8, D12, D13	Diode, Zener, 12 V, 500 mW, SOD-123	MMSZ5242BT1G	ON Semiconductor
2	F1	Fuse clip, 5x20 mm	0100056H	Wickmann
3	HS1, HS2, HS3	Heatsink, vertical mount, clip extrusion	782653B02000	Aavid
2	J1, J2	Terminal block, 2 pin, 15 A, 5.1 mm	ED120/2DS	OST
2	J3, J4	Copper, single barrel, one-hole, straight tongue (fixed) lug, #14 - #4 AWG wire, 1/4 stud hole."	CX70-14-CY	Panduit
1	J5	Conn recept 14 POS 2 mm PCB tin female	DF11-14DS-2DSA(05)	HRS
1	L1	Inductor, 2.0 μH	75PR8108	Vitec Electronics Corp
1	L2	Inductor, 26 μH, quad, ±18%	60PR964	Vitec Electronics Corp
4	Q1, Q2, Q3, Q4	MOSFET, N-channel, 650 V, 20 A, 220 mΩ, TO-220V	SPP20N60CFD	Infineon
2	Q5, Q6	MOSFET, N-channel, 75-V, 120-A, 2.5 mΩ, TO-220 V	FDP032N08	Fairchild
1	R1	Resistor, chip, 1/10 W, 48.7 Ω, 1%, 0805	Std	Std
1	R11	Resistor, chip, 1/10 W, 49.9 Ω, 1%, 0805	Std	Std
1	R2	Resistor, chip, 1/10 W, 4.87 kΩ, 1%, 0805	Std	Std
1	R22	Resistor, chip, 1/10 W, 0 Ω, 1%, 0805	Std	Std

Table 4. UCC28950EVM-442 List of Materials (continued)

COUNT	REF DES	DESCRIPTION	PART NUMBER	MFR
8	R3, R5, R12, R13, R18, R19, R20, R21	Resistor, chip, 1/10 W, 3.01 Ω , 1%, 0805	Std	Std
3	R4, R14, R17	Resistor, chip, 1/10 W, 1.00 M Ω , 5%, 0805	Std	Std
1	R6	Resistor, chip, 1 W, 100 k Ω , 1%, 2512	Std	Std
6	R7, R10, R15, R16, R23, R24	Resistor, chip, 1/10 W, 10.0 k Ω , 1%, 0805	Std	Std
2	R8, R9	Resistor, power metal strip, 2 W, 1 k Ω , \pm 5%, 4527	Std	Std
1	T1	XFMR, current sense	PE63587	Pulse
1	T2	Transformer	75PR8107	Vitec Electronics
2	T3, T4	Transformer, gate drive	56PR3362	Vitec Electronics
3	U1, U2, U3	High Speed Low Side Power MOSFET driver, S08	UCC27324D	TI
1	--	PCB, 7.1 In x 3.8 In x 0.062 In	HPA442	Any
Additional Hardware				
1	X1 @ F1	Fast acting fuse, 2 A	BK/S501-2-R	Cooper/Bussman
6	"X1 @ HS1,HS2, HS3"	Screw steel M3 thr 6 mm	29311	Keystone Electronics
6	"X1 @ HS1,HS2, HS3"	Washer lock metric M3 zinc	MLWZ 003	B&F Fastener Supply
6	"X1 @ HS1,HS2, HS3,Q1, Q2 Q3, Q4, Q5, Q6"	Thermal pad tube, needs to be cut to 22 mm	BER156-ND	Bergquist
6	"X1 @ HS1,HS2, HS3,Q1, Q2, Q3, Q4, Q5, Q6"	MAX clip	MAX01G	Aavid
1	X2@J5	UCC28950 daughter card assembly	HPA471	Any

UCC28950EVM-442 daughter controller card power stage list according to the schematic in [Figure 2](#).

Table 5. UCC28950EVM-442 List of Materials

COUNT	REFDES	DESCRIPTION	PART NUMBER	MFR
2	C1, C5	Capacitor, ceramic, 25 V, X7R, 1 μ F, +/-10% 0805	Std	Std
1	C2	Capacitor, ceramic, 25 V, X7R, 150 nF, +/-10% 0805	Std	Std
1	C3	Capacitor, ceramic, 25 V, X7R, 5.6 nF, +/-10% 0805	Std	Std
1	C4	Capacitor, ceramic, 25 V, X7R, 560 pF, +/-10% 0805	Std	Std
1	C6	Capacitor, ceramic, 25 V, X7R, 0.1 μ F, +/-10% 0805	Std	Std
1	C7	Capacitor, ceramic, 25 V, X7R, 330 pF, +/-10% 0805	Std	Std
1	C8	No pop capacitor, ceramic, 25 V, X7R, +/-10% 0805	Std	Std
1	J1	Header, right angle 14 pins	DF11-14DP-2DSxx	HRS
1		HPA471 EVM daughter board PCB		
3	R1, R2, R7	Resistor, chip, 1/10 W, 2.37 k Ω , 1% 0805	Std	Std
1	R10	Resistor, chip, 1/10 W, 12.1 k Ω , 1% 0805	Std	Std
1	R11	Resistor, chip, 1/10 W, 61.9 k Ω , 1% 0805	Std	Std
1	R14	Resistor, chip, 1/10 W, 127 k Ω , 1% 0805	Std	Std
1	R15	Resistor, chip, 1/10 W, 22.6 Ω , 1% 0805	Std	Std
4	R17, R20, R21, R26	Resistor, chip, 1/10 W, 0, 1% 0805	Std	Std
3	R18, R22, R25	Resistor, chip, 1/10 W, 1.00 k Ω , 1% 0805	Std	Std
1	R24	Resistor, chip, 1/10 W, 16.2 k Ω , 1% 0805	Std	Std
2	R3, R4	Resistor, chip, 1/10 W, 15.4 k Ω , 1% 0805	Std	Std
8	R5, R12, R13, R16, R19, R23, R27, R28	No pop resistor, chip, 1/10 W, 1% 0805	Std	Std
1	R6	Resistor, chip, 1/10 W, 9.09 k Ω , 1% 0805	Std	Std
1	R8	Resistor, chip, 1/10 W, 71.5 k Ω , 1% 0805	Std	Std
1	R9	Resistor, chip, 1/10 W, 27.4 k Ω , 1%0805	Std	Std
1	U1	UCC28950PW, Advanced Phase-Shifted PWM Controller TSSOP-24	UCC28950PW	TI

Evaluation Board/Kit Important Notice

Texas Instruments (TI) provides the enclosed product(s) under the following conditions:

This evaluation board/kit is intended for use for **ENGINEERING DEVELOPMENT, DEMONSTRATION, OR EVALUATION PURPOSES ONLY** and is not considered by TI to be a finished end-product fit for general consumer use. Persons handling the product(s) must have electronics training and observe good engineering practice standards. As such, the goods being provided are not intended to be complete in terms of required design-, marketing-, and/or manufacturing-related protective considerations, including product safety and environmental measures typically found in end products that incorporate such semiconductor components or circuit boards. This evaluation board/kit does not fall within the scope of the European Union directives regarding electromagnetic compatibility, restricted substances (RoHS), recycling (WEEE), FCC, CE or UL, and therefore may not meet the technical requirements of these directives or other related directives.

Should this evaluation board/kit not meet the specifications indicated in the User's Guide, the board/kit may be returned within 30 days from the date of delivery for a full refund. **THE FOREGOING WARRANTY IS THE EXCLUSIVE WARRANTY MADE BY SELLER TO BUYER AND IS IN LIEU OF ALL OTHER WARRANTIES, EXPRESSED, IMPLIED, OR STATUTORY, INCLUDING ANY WARRANTY OF MERCHANTABILITY OR FITNESS FOR ANY PARTICULAR PURPOSE.**

The user assumes all responsibility and liability for proper and safe handling of the goods. Further, the user indemnifies TI from all claims arising from the handling or use of the goods. Due to the open construction of the product, it is the user's responsibility to take any and all appropriate precautions with regard to electrostatic discharge.

EXCEPT TO THE EXTENT OF THE INDEMNITY SET FORTH ABOVE, NEITHER PARTY SHALL BE LIABLE TO THE OTHER FOR ANY INDIRECT, SPECIAL, INCIDENTAL, OR CONSEQUENTIAL DAMAGES.

TI currently deals with a variety of customers for products, and therefore our arrangement with the user **is not exclusive.**

TI assumes **no liability for applications assistance, customer product design, software performance, or infringement of patents or services described herein.**

Please read the User's Guide and, specifically, the Warnings and Restrictions notice in the User's Guide prior to handling the product. This notice contains important safety information about temperatures and voltages. For additional information on TI's environmental and/or safety programs, please contact the TI application engineer or visit www.ti.com/esh.

No license is granted under any patent right or other intellectual property right of TI covering or relating to any machine, process, or combination in which such TI products or services might be or are used.

FCC Warning

This evaluation board/kit is intended for use for **ENGINEERING DEVELOPMENT, DEMONSTRATION, OR EVALUATION PURPOSES ONLY** and is not considered by TI to be a finished end-product fit for general consumer use. It generates, uses, and can radiate radio frequency energy and has not been tested for compliance with the limits of computing devices pursuant to part 15 of FCC rules, which are designed to provide reasonable protection against radio frequency interference. Operation of this equipment in other environments may cause interference with radio communications, in which case the user at his own expense will be required to take whatever measures may be required to correct this interference.

EVM Warnings and Restrictions

It is important to operate this EVM within the input voltage range of 370 V to 410 V and the output voltage range of 11.4 V to 12.6 V.

Exceeding the specified input range may cause unexpected operation and/or irreversible damage to the EVM. If there are questions concerning the input range, please contact a TI field representative prior to connecting the input power.

Applying loads outside of the specified output range may result in unintended operation and/or possible permanent damage to the EVM. Please consult the EVM User's Guide prior to connecting any load to the EVM output. If there is uncertainty as to the load specification, please contact a TI field representative.

During normal operation, some circuit components may have case temperatures greater than 50° C. The EVM is designed to operate properly with certain components above 50° C as long as the input and output ranges are maintained. These components include but are not limited to linear regulators, switching transistors, pass transistors, and current sense resistors. These types of devices can be identified using the EVM schematic located in the EVM User's Guide. When placing measurement probes near these devices during operation, please be aware that these devices may be very warm to the touch.

Mailing Address: Texas Instruments, Post Office Box 655303, Dallas, Texas 75265
Copyright © 2010, Texas Instruments Incorporated

IMPORTANT NOTICE

Texas Instruments Incorporated and its subsidiaries (TI) reserve the right to make corrections, modifications, enhancements, improvements, and other changes to its products and services at any time and to discontinue any product or service without notice. Customers should obtain the latest relevant information before placing orders and should verify that such information is current and complete. All products are sold subject to TI's terms and conditions of sale supplied at the time of order acknowledgment.

TI warrants performance of its hardware products to the specifications applicable at the time of sale in accordance with TI's standard warranty. Testing and other quality control techniques are used to the extent TI deems necessary to support this warranty. Except where mandated by government requirements, testing of all parameters of each product is not necessarily performed.

TI assumes no liability for applications assistance or customer product design. Customers are responsible for their products and applications using TI components. To minimize the risks associated with customer products and applications, customers should provide adequate design and operating safeguards.

TI does not warrant or represent that any license, either express or implied, is granted under any TI patent right, copyright, mask work right, or other TI intellectual property right relating to any combination, machine, or process in which TI products or services are used. Information published by TI regarding third-party products or services does not constitute a license from TI to use such products or services or a warranty or endorsement thereof. Use of such information may require a license from a third party under the patents or other intellectual property of the third party, or a license from TI under the patents or other intellectual property of TI.

Reproduction of TI information in TI data books or data sheets is permissible only if reproduction is without alteration and is accompanied by all associated warranties, conditions, limitations, and notices. Reproduction of this information with alteration is an unfair and deceptive business practice. TI is not responsible or liable for such altered documentation. Information of third parties may be subject to additional restrictions.

Resale of TI products or services with statements different from or beyond the parameters stated by TI for that product or service voids all express and any implied warranties for the associated TI product or service and is an unfair and deceptive business practice. TI is not responsible or liable for any such statements.

TI products are not authorized for use in safety-critical applications (such as life support) where a failure of the TI product would reasonably be expected to cause severe personal injury or death, unless officers of the parties have executed an agreement specifically governing such use. Buyers represent that they have all necessary expertise in the safety and regulatory ramifications of their applications, and acknowledge and agree that they are solely responsible for all legal, regulatory and safety-related requirements concerning their products and any use of TI products in such safety-critical applications, notwithstanding any applications-related information or support that may be provided by TI. Further, Buyers must fully indemnify TI and its representatives against any damages arising out of the use of TI products in such safety-critical applications.

TI products are neither designed nor intended for use in military/aerospace applications or environments unless the TI products are specifically designated by TI as military-grade or "enhanced plastic." Only products designated by TI as military-grade meet military specifications. Buyers acknowledge and agree that any such use of TI products which TI has not designated as military-grade is solely at the Buyer's risk, and that they are solely responsible for compliance with all legal and regulatory requirements in connection with such use.

TI products are neither designed nor intended for use in automotive applications or environments unless the specific TI products are designated by TI as compliant with ISO/TS 16949 requirements. Buyers acknowledge and agree that, if they use any non-designated products in automotive applications, TI will not be responsible for any failure to meet such requirements.

Following are URLs where you can obtain information on other Texas Instruments products and application solutions:

Products		Applications	
Amplifiers	amplifier.ti.com	Audio	www.ti.com/audio
Data Converters	dataconverter.ti.com	Automotive	www.ti.com/automotive
DLP® Products	www.dlp.com	Communications and Telecom	www.ti.com/communications
DSP	dsp.ti.com	Computers and Peripherals	www.ti.com/computers
Clocks and Timers	www.ti.com/clocks	Consumer Electronics	www.ti.com/consumer-apps
Interface	interface.ti.com	Energy	www.ti.com/energy
Logic	logic.ti.com	Industrial	www.ti.com/industrial
Power Mgmt	power.ti.com	Medical	www.ti.com/medical
Microcontrollers	microcontroller.ti.com	Security	www.ti.com/security
RFID	www.ti-rfid.com	Space, Avionics & Defense	www.ti.com/space-avionics-defense
RF/IF and ZigBee® Solutions	www.ti.com/lprf	Video and Imaging	www.ti.com/video
		Wireless	www.ti.com/wireless-apps