

DRV10963 Evaluation Module

This document is provided with the DRV10963 customer evaluation module (EVM) as a supplement to the DRV10963 datasheet ([SLAS955A](#)). It details the hardware implementation of the EVM and gives a step-by-step introduction to the device operation and tuning process using DRV10963 GUI.

Contents

1	DRV10963 EVM Kit Contents	2
2	Introduction	3
3	DRV10963 Motherboard Connectors	4
	3.1 Power Input	4
	3.2 Interface Connectors to Mount Daughterboard P1, P2	4
	3.3 USB to Any Connector	5
4	DRV10963 Daughterboard Connectors	5
	4.1 Motor Output Connector	5
	4.2 Interface Connectors to Motherboard P1, P2	5
5	Quick Start Guide	6
	5.1 Installation of Software	6
	5.2 Initial Hardware Settings	6
	5.3 Jumpers and Switch Setup Settings	7
	5.4 Powering-Up EVM	7
	5.5 Tuning GUI: to Configure Motor Parameter	8
6	Tuning Guide.....	13
	6.1 Configuring the Device	13
	6.2 Writing to the OTP Registers	16
	6.3 Reading the OTP Values.....	18
	6.4 Notes.....	18
7	Schematic and Bill of Materials.....	20
	7.1 Schematic	20
	7.2 Bill of Materials (BOM).....	22

List of Figures

1	DRV10963 Motherboard with Socket Daughterboard Mounted on top	3
2	DRV10963 Daughterboard Mounting on Motherboard	6
3	DRV10963 Orientation Inside Daughterboard Socket	7
4	GUI Initial Screen With Demo Mode	8
5	GUI Screen With Successful I2C Interface	9
6	Default Configuration Parameters.....	10
7	Loading DRV10963JM Configuration Parameter to Device	11
8	DRV10963JM Configuration Parameter	12
9	Initial Tuning Flow Chart.....	12
10	Error Message	13
11	Correct Align Time and Acceleration Rate	14
12	Align Time Too Long.....	14
13	Align Time Too Short	14
14	Open to Close Loop Threshold Too Low.....	14

15	Open to Close Loop Threshold Too High	14
16	Current Limit Too High	15
17	Current Limit Very Small	15
18	Load Custom Configurations to GUI	17
19	Motor Hitting Current Limit and Trying Again	18
20	OTC Threshold not Optimized	18
21	Register Error Message	19
22	DRV10963 Motherboard Schematic	20
23	DRV10963 Daughterboard Schematic	21

List of Tables

1	Connector P1: Daughterboard	4
2	Connector P2: Daughterboard	4
3	Connector P1: Motherboard	5
4	Connector P2: Motherboard	5
5	DRV10963 Motherboard Bill of Materials	22
6	DRV10963 Daughterboard Bill of Materials	23

1 **DRV10963 EVM Kit Contents**

The DRV10963 evaluation kit contains following:

1. DRV10963 motherboard circuit card
2. DRV10963 daughterboard circuit card
3. USB2ANY communication board for I2C GUI interaction
4. USB cable
5. 10-pin ribbon cable to connect USB2ANY and DRV10963 motherboard
6. DRV10963 EVM GUI

The DRV10963 EVM boards and GUI are designed to work together for tuning device to optimize the performance for a given application.

3 DRV10963 Motherboard Connectors

3.1 Power Input

The DRV 10963 requires two external power supply levels (6.2 V and 5 V) to operate the GUI via the I²C interface. Connector P3 provides the required interface for external power supply. The pin assignment of terminal P1 is as follows:

Pin	Description
1	GND
2	GND
3	Vtestmode-6.2 V to 7.2 V
3	Vpower-in-5.0 V to 6.0 V

3.2 Interface Connectors to Mount Daughterboard P1, P2

Connectors P1,P2 are used to interface the daughter socket board. The pin assignments are as follows:

Table 1. Connector P1: Daughterboard

Pin	Description
1, 2	NC
3	FR- Dual functionality: 1. Forward reverse for motor direction 2. Data signal for I ² C
4	PWM, Dual functionality: 1. Motor speed control 2. Clock signal for I ² C
5	FGS- Motor speed indicator selector
6	FG- Motor speed indicator output (open drain)
7	TOSC- To enable OTP programming
8, 9, 10, 11	NC

Table 2. Connector P2: Daughterboard

Pin	Description
1,2	VCC- 5-Volt power input
3	NC
4, 5	Phase-W
6, 7	Phase-U
8, 9	Phase-V
10, 11	GND

3.3 USB to Any Connector

The Connector USB2ANY is used for the I²C interconnection with the GUI. The pin assignment is as follows:

Pin	Description
1, 2, 3, 4, 5	NC
6	GND
7	NC
8	FGS Control- For Internal Factory Testing
9	SCLK- Clock signal for I2C communication with GUI
10	SDATA- Data signal for I2C communication with GUI

4 DRV10963 Daughterboard Connectors

4.1 Motor Output Connector

The DRV10963 daughterboard provides the 3-terminal connector P3 to connect 3-phase BLDC motor. Pin assignment of terminal P3 is as follows:

Pin	Description
1	U
2	W
3	V

4.2 Interface Connectors to Motherboard P1, P2

Connectors P1,P2 are used to interface signals coming from the motherboard to the device via socket. The pin assignments are as follows:

Table 3. Connector P1: Motherboard

Pin	Description
1, 2	NC
3	FR- Dual functionality: 1. Forward reverse for motor direction 2. Data signal for I ² C
4	PWM, Dual functionality: 1. Motor speed control 2. Clock signal for I ² C
5	FGS- Motor speed indicator selector
6	FG- Motor speed indicator output (open drain)
7	TOSC- To enable OTP programming

Table 4. Connector P2: Motherboard

Pin	Description
1, 2	VCC- 5-Volt power input
3	NC
4, 5	Phase-W
6, 7	Phase-U
8, 9	Phase-V
10, 11	GND

5 Quick Start Guide

5.1 Installation of Software

If this your first encounter with the DRV10963, before proceeding to next step, install the following software packages to use the DRV10963 GUI for tuning the motor:

1. The DRV10963 EVM is provided with a GUI to configure the device and tune the application. Refer to DRV10963_2P0 User Manual.pdf present (C:\Program Files (x86)\Texas Instruments\DRV10963_2P0 EVM\Documents) in the GUI-installed directory for instructions to download and install the GUI application. Create a desktop shortcut with the name DRV10963_2P0 EVM, for future use.
2. Install the Run-Time Engine LabVIEW-2014 from the following link, for complete instructions, refer to <http://www.ni.com/download/labview-run-time-engine-2014/4887/en>

CAUTION

Do not apply power to board before you have verified settings mentioned in [Section 5.2](#) and [Section 5.3](#)!

5.2 Initial Hardware Settings

The kit ships with the daughterboard already mounted on top of the motherboard. The daughter socket board also has a pre-inserted DRV0963 blank version device, however, ensure:

- The daughterboard is rigidly inserted on the motherboard without any loose connection. Check the orientation of the daughterboard with VCC_IN test-point connected to the right corner. Refer to [Figure 2](#) for details and read instructions written on the motherboard for proper orientation.
- The DRV10963 device is properly inserted with right orientation at the socket in the daughter card as per [Figure 3](#), referred to as U1.

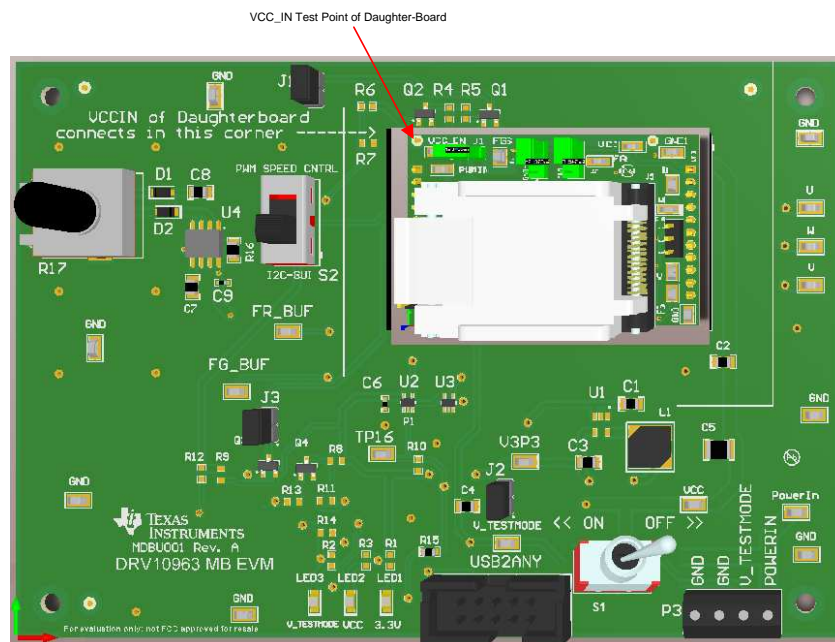

Figure 2. DRV10963 Daughterboard Mounting on Motherboard

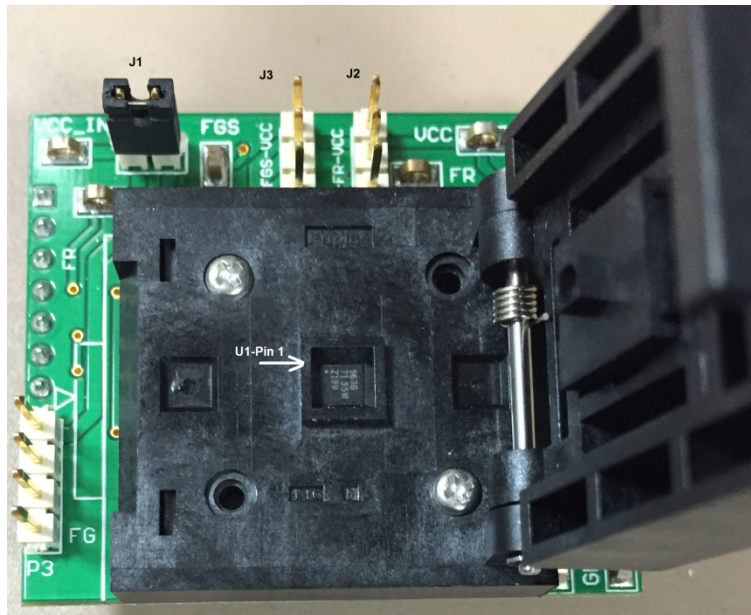

Figure 3. DRV10963 Orientation Inside Daughterboard Socket

5.3 Jumpers and Switch Setup Settings

On the daughterboard:

1. Make sure that only jumper J1 is populated, jumper J2 and J3 all 3-pins shall be open

On motherboard:

1. Make sure that all jumpers J1, J2, and J3 are populated
2. Switch S1 should be in the off position and switch S2 in the I²C-GUI position. DRV10963 PWM input pin has dual functionality, that is, it serves as speed control input as well as clock signal for I²C. Switch S2 provides a means to configure the PWM input pin for speed control or I²C clock.

5.4 Powering-Up EVM

DRV10963 EVM requires two power supply sources, that is, 5 V and 6.2 V to work with the GUI to enable I²C interface for register configuration. Note that programmed device needs only one 5-V supply in the final end-application circuit. Use the following sequence to power-up the EVM and to establish a successful connection with the GUI:

1. Do not power up the power supply. First, connect the power supply ground to pin GND, the 6.2 V to pin V_Testmode, and 5 V to PowerIn on the motherboard at connector P3. At this point, make sure that switch S1 is in the turn-off position and the “USB2Any” board is not connected to the motherboard. If using a lab power supply, it is recommended to set the current limit of both power supplies to 1.5 A.
2. Turn the POT-R17 fully CCW (counter-clock wise). This keeps the speed PWM input to the minimum value.
3. Connect the 3-phase terminal of motor to connector P4 on the daughterboard. It is not important to observe the polarity as it only determines the direction of rotation.
4. Now power up the board and turn switch S1 to the “on” position. Check LED1, LED2, and LED3. All should turn green.
5. Connect USB2Any box first, via the supplied USB cable to the computer. Then connect the 10-pin ribbon cable to the USB2ANY connector on the motherboard.

5.5 Tuning GUI: to Configure Motor Parameter

Use the following steps to configure the motor parameters.

1. Now launch the DRV10963EVM GUI by double clicking the DRV10963_2P0 EVM shortcut on the desktop. If "Demo Mode" is selected, the screen shown in [Figure 4](#) appears, deselect "Demo Mode" to go to the next step.

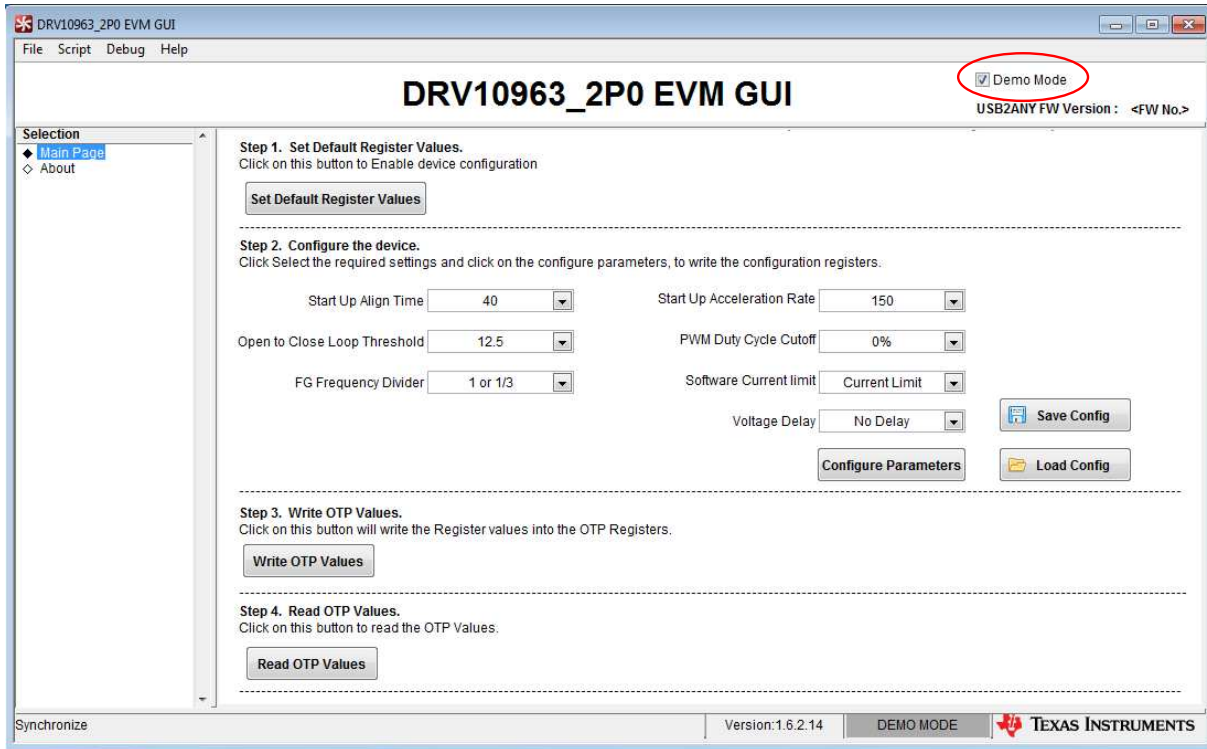

Figure 4. GUI Initial Screen With Demo Mode

2. If "Demo Mode" is not select previously, the screen shown in [Figure 5](#) appears as soon as the GUI launches. The "CONNECTED" block should turn green indicating that the GUI is successfully connected to USB2ANY.

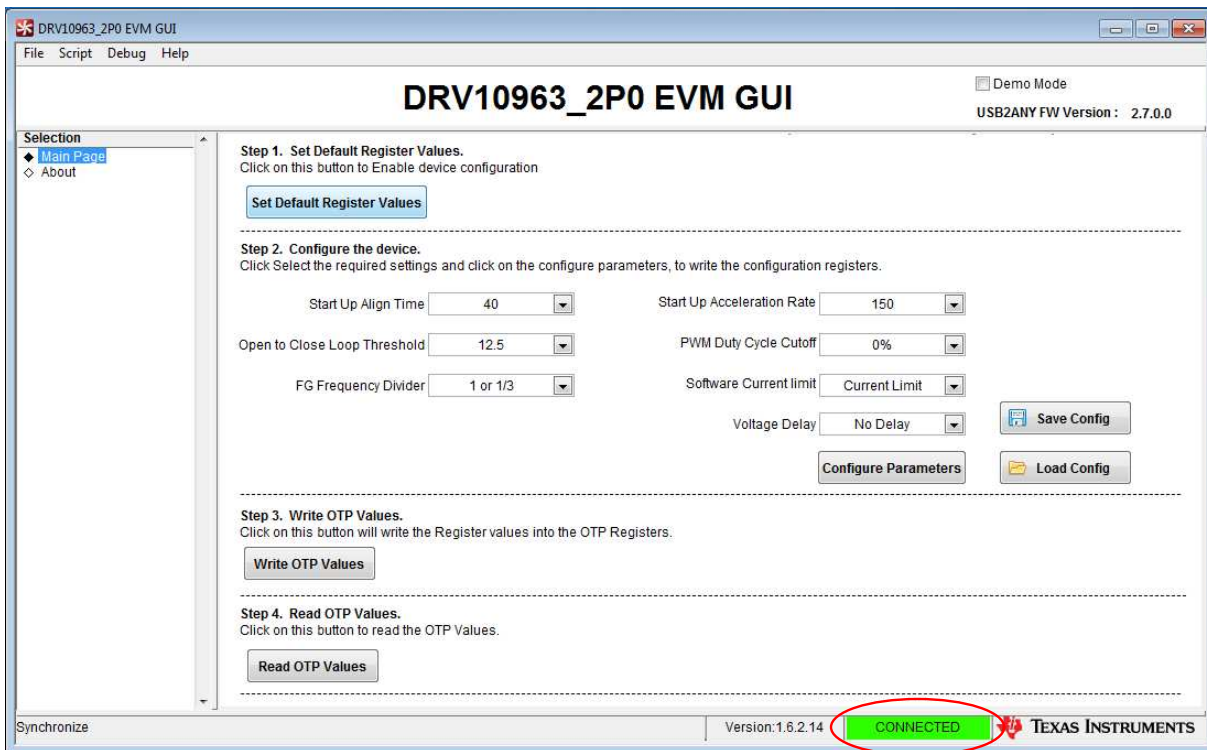

Figure 5. GUI Screen With Successful I2C Interface

- Left-click on the step 1 button "Set Default Resister Values". Step 1 is always mandatory before proceeding to step 2 to enable configuration of the device. This step programs the following parameters to the corresponding shadow register, as shown in [Figure 6](#). These default values correspond to the factory programmed part DRV10963JJ. Refer to the DRV10963 datasheet for a detailed explanation of different versions of DRV10963 and descriptions of tunable parameters.

- "Start Up Align Time" - 350 ms and "Start-up Acceleration Rate" - 80 Hz/s
- "Open to Close Loop Threshold" - 100 Hz
- "PWM Duty Cycle Cutoff" - 10%
- "FG Frequency Divider" - 1 or 1/3
- "Software Current limit" - 500 mA
- "Voltage Delay" - 120 μ s

To enable motor spin with the above parameters, open the jumper J1 on the motherboard. There is a high probability that the motor will start rotating with previously shown default values. This state is equivalent to driving the motor at maximum speed with 100% duty cycle because PWM input being connected to the I²C clock input continues to receive a high signal. Ensure that the parameters previously shown are optimized for their end application. Refer to [Section 6](#) for guidelines to optimally determine and tune motor parameters using the GUI.

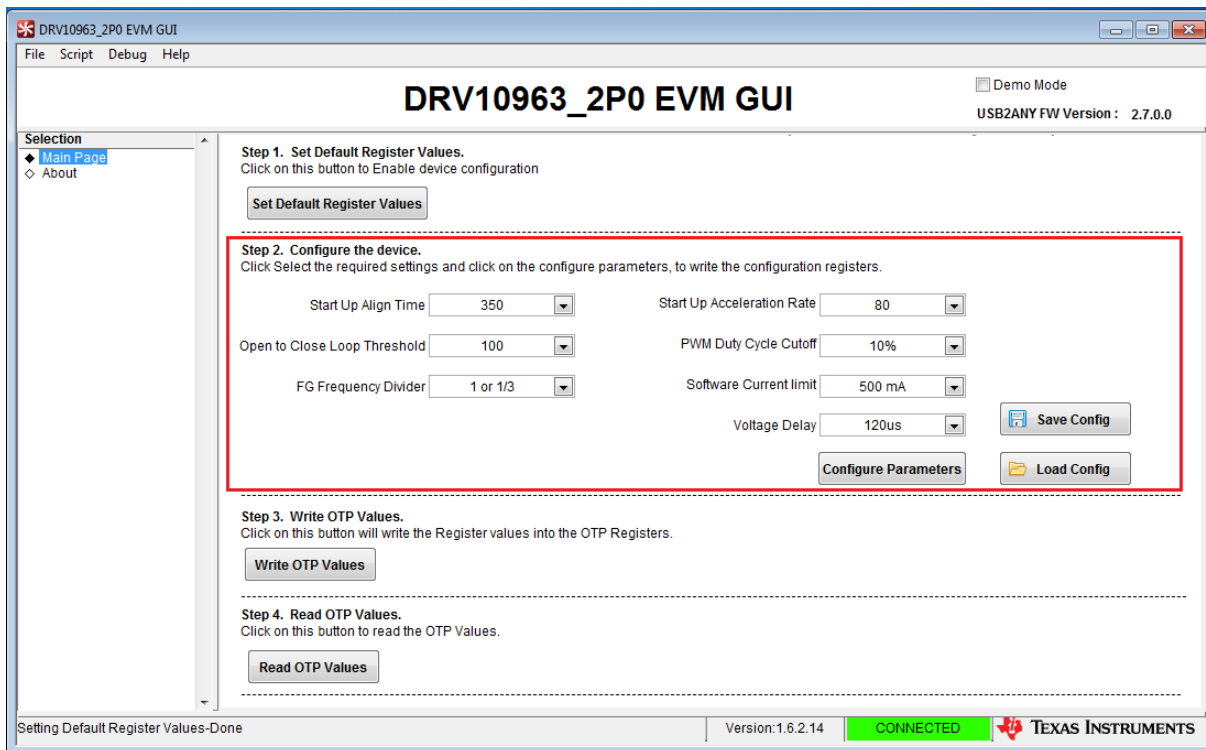

Figure 6. Default Configuration Parameters

4. To facilitate the tuning at different speeds or across a speed range, the EVM provides a TLC555 timer-based PWM generation circuit and potentiometer (R17) to adjust the duty cycle of PWM to control the speed of the motor. To enable speed control via POT-R17, change the switch S2 position to PWM Speed Control mode. Turn the POT-R17 clock-wise to increase the motor speed and counter-clockwise to reduce it.
5. In case motor performance is not satisfactory with default values or further optimization is desired, try three other factory-programmed device options before attempting to customize parameters. This would benefit in production phase because all versions of factory programmed devices can be easily procured and used directly without the burden to programming the OTP values. The GUI comes with three .txt files corresponding to the three remaining factory-programmed devices.
6. To test motor performance with the DRV10963JM version, short the jumper J1 back. This will stop the motor. Referring to [Figure 7](#), left-click the "Load Config" button, browse to the GUI installation directory for 3 .txt files in your PC and select DRV10963JM.txt. This will load the register with configuration parameters corresponding to DRV10963JM. Refer to [Figure 8](#) to check configuration parameters corresponding to the DRV10963JM version. In same way, load and configure other versions of DRV10963 to test the performance. To enable motor spin, open the jumper J1 on the motherboard and use POT R-17 for speed control.

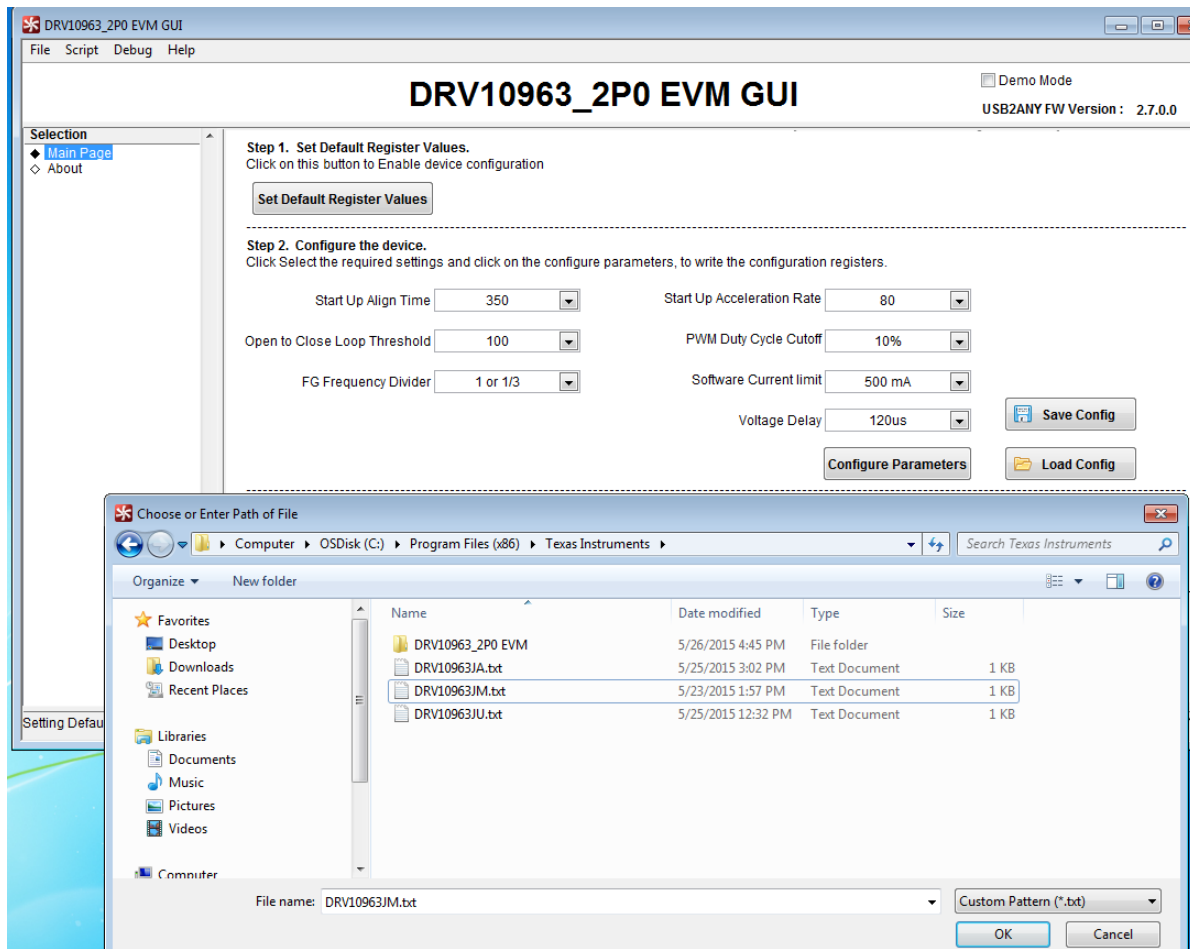

Figure 7. Loading DRV10963JM Configuration Parameter to Device

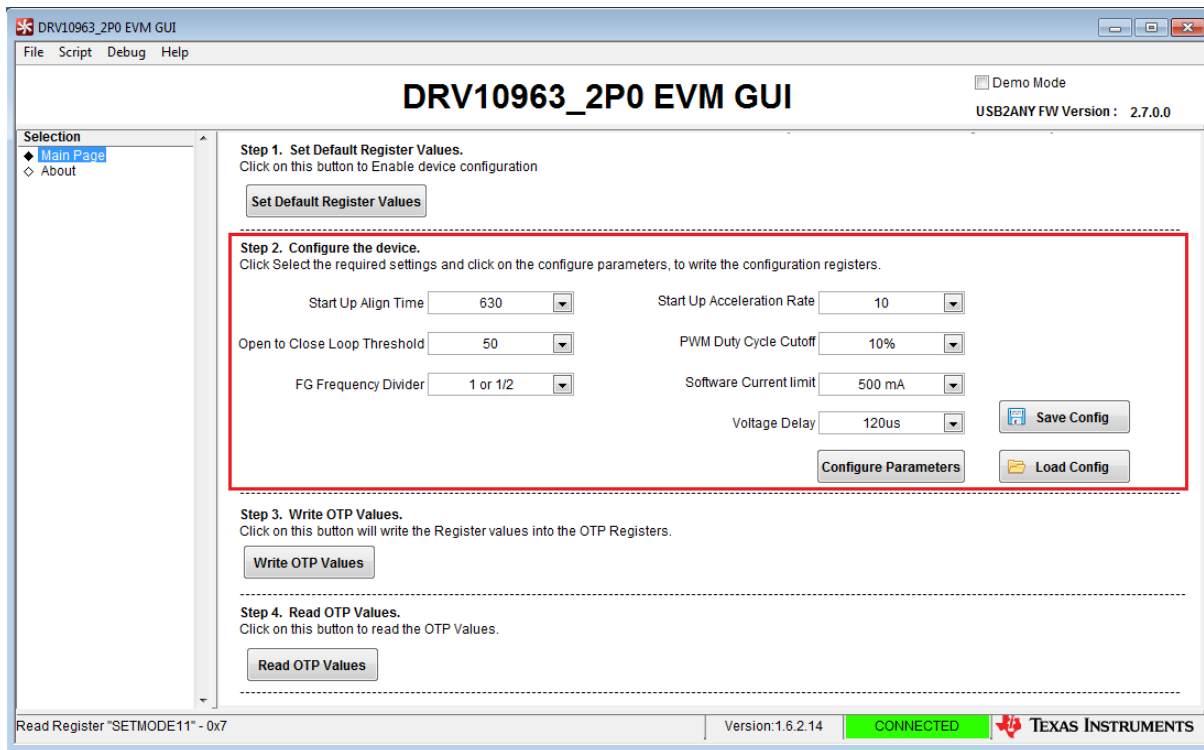

Figure 8. DRV10963JM Configuration Parameter

- After trying DRV10963JM, the next file to load is the DRV10963JU configuration followed by loading the DRV10963JA.
- If only one of the preloaded configurations spins the motor, then obviously that is the part number to order to control the motor. However, if two or more spin the motor, then refer to Figure 9.

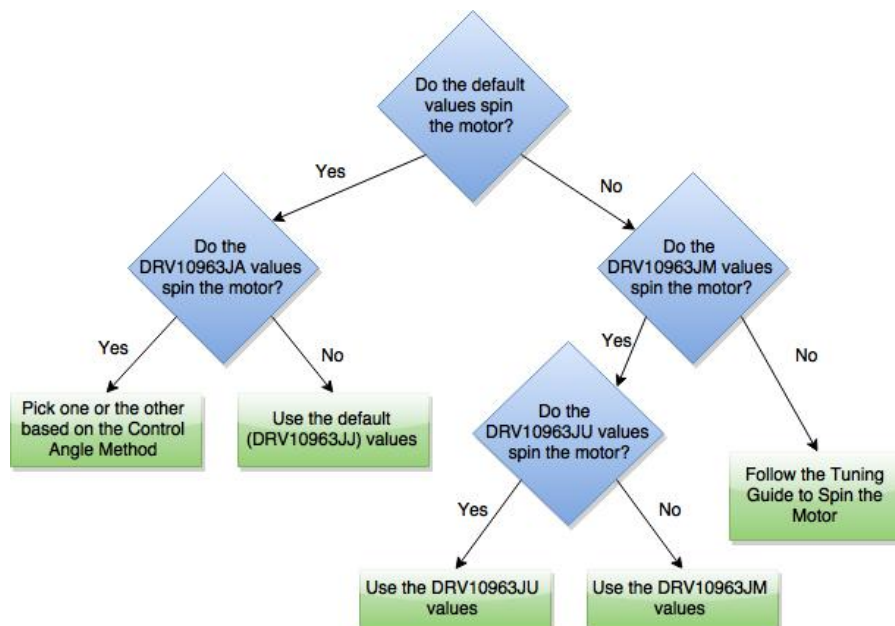

Figure 9. Initial Tuning Flow Chart

9. Even if one of the four factory-programmed settings do spin the motor, it may not be optimized for that motor. Using whichever DRV10963xx file as a starting point, then run through the tuning guide in [Section 6](#) to create the best settings. However, for convenience it would be easier to just order a factory-programmed part. The "Control Advance Angle Method is described in [Section 6.1.6](#).

6 Tuning Guide

If all four of the given factory-programmed settings have been tried (3 .txt files and the default values) and the motor still will not spin or you would like to further optimize your motor then you can try the following steps to custom tune the DRV10963 for your motor.

6.1 Configuring the Device

Leave the device connected to the motor and the computer. Next, make sure that the DRV10963EVM is powered up in test mode and the GUI is open. If an error message like the one in [Figure 10](#) is returned, just close the GUI and reopen it and make sure that it reconnects to the device.

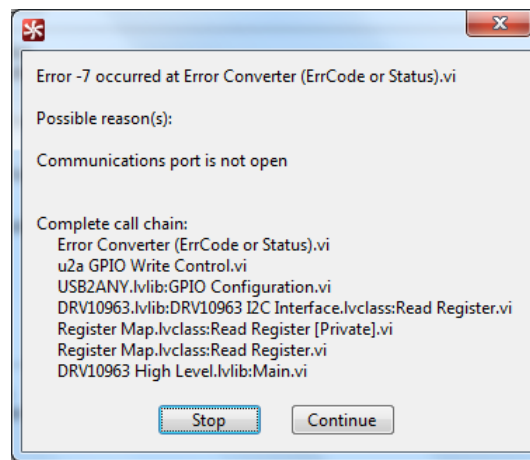

Figure 10. Error Message

Each one of the parameters that you can configure with the GUI will change how your motor reacts to the DRV10963 device. Read the description of each one of the parameters below and then choose if you would like to make the changes suggested. Be sure to connect a current probe to phase V to observe the phase current during tuning.

6.1.1 Start UP Align Time and Start Up Acceleration Rate

Start-up align time and acceleration rate determines how fast the motor can reach a particular set speed from standstill, so these values should be chosen to get the fastest possible start-up time. Note that too aggressive values of acceleration rate can cause higher inrush current in starting and may hit overcurrent protection, in which case the motor may not be able to start successfully. It is better to start with slower values and gradually increases to get the fastest possible start-up time based on the application. In the DRV10963 device, both the values are dependent on each other. They can only be configured as a dependent pair. The values tunable from the GUI of align time is in ms and acceleration rate is in Hz/sec.

Using the motor inertia from the motor parameters previously determined, estimate the align time. If you do not know, just input the highest possible align time which will correspond to the lowest possible acceleration rate. Then, after tuning the rest of the parameters is complete, come back to align time and step it down one-by-one until the fan will not spin. Then you know the best align time is the value just before the one where the fan stopped.

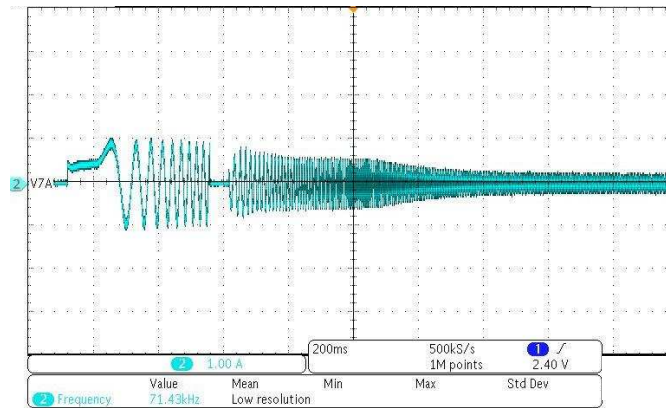
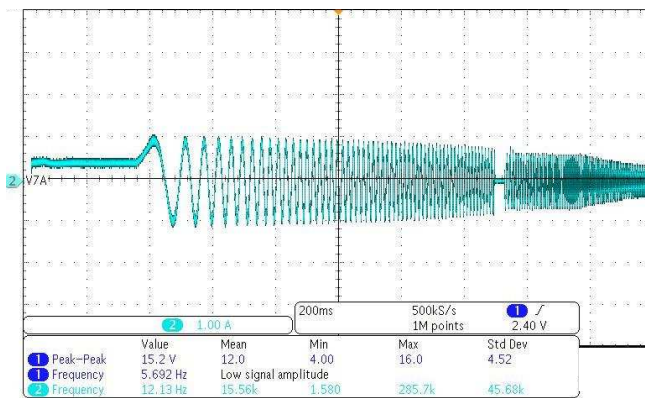
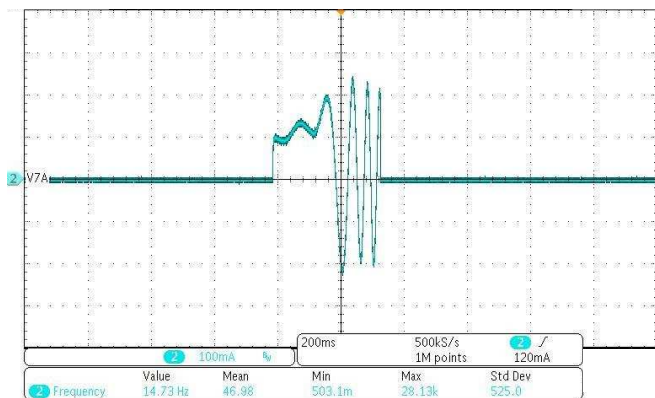
Figure 11. Correct Align Time and Acceleration Rate

Figure 12. Align Time Too Long

Figure 13. Align Time Too Short

6.1.2 Open to Close Loop Threshold

Open to close loop threshold determines the threshold frequency at which the controller goes from open-loop commutation to closed-loop, back-emf, zero-crossing-based commutation. For best performance to get stability during dynamic load/speed changing conditions and for maximum possible speed range, the motor should run in closed-loop commutation mode, therefore, the threshold frequency should be chosen as low as possible. However, too low values will cause an issue with sensor-less control because back-emf will not be sufficient to allow closed loop operation. Typically this threshold should be 10% to 25% of the speed desired to run the motor. The values tunable via GUI are in units of Hz. Normally, higher-speed motors (maximum speed) require a higher handoff threshold because higher speed motors have lower Kt, and as a result, lower BEMF.

In other words, if your desired RPM is 3000, then the open to close loop threshold should be $1/4 \times (500 \text{ rpm}) = 125 \text{ Hz}$. Therefore, the open to close loop threshold should be around $50 \approx 125 \text{ Hz}$.

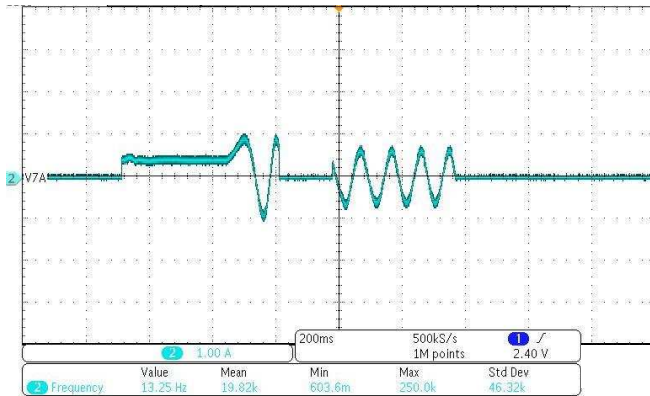

Figure 14. Open to Close Loop Threshold Too Low

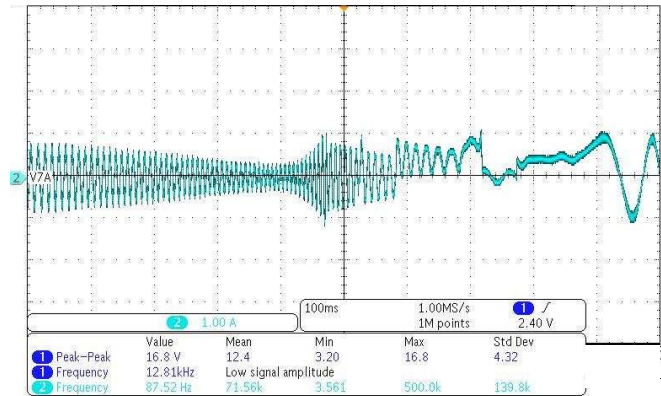

Figure 15. Open to Close Loop Threshold Too High

6.1.3 PWM Duty Cycle Cutoff

PWM duty cycle cutoff decides the minimum operating duty cycle; this can be chosen to meet minimum speed requirements. Refer to the DRV10963 datasheet for more information about the different minimum duty cycles.

6.1.4 FG Frequency Divider

The FG pin provides an indication of the speed of the motor. There are two options, 1 or 1/2 toggles FG once every 2 electrical cycles and 1 or 1/3, toggles FG once every 3 electrical cycles. This signal can be used to get the motor speed feedback information. In order to see this relationship off of the FG pin on the daughterboard, the device must be taken out of test mode by opening the jumper J1 on the motherboard, using the POT R-17 for speed control, and the FGS pin must be driven low. For more information about this, refer to the DRV10963 datasheet.

6.1.5 Software Current Limit

The software current limit function is only available in closed loop commutation mode. It works more like an active current or better as torque limit, and does not cause overcurrent trip. This value can tune to get a particular speed at a given motor loading condition. For example, increasing its value increases the motor-applied torque and thus the speed, however, ensure that the value is not exuberantly high to prevent motor heating. A lower value will prevent the motor from reaching a higher speed.

Start out at 0.125 A to make sure that your motor will spin and then slowly start to increase the current limit until it fails, then use the current limit right before.

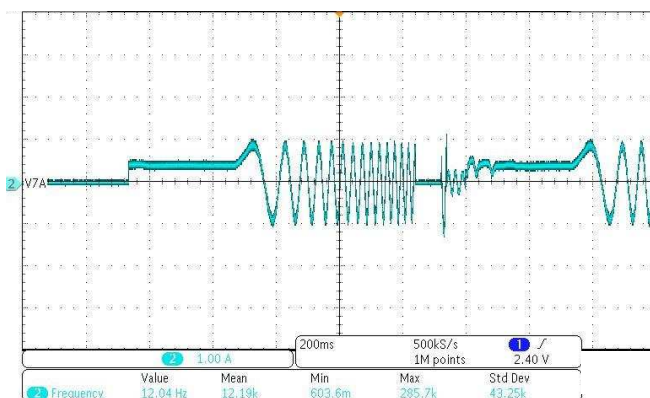

Figure 16. Current Limit Too High

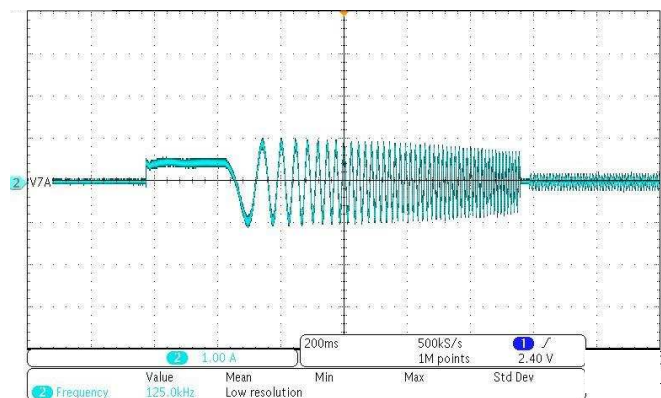

Figure 17. Current Limit Very Small

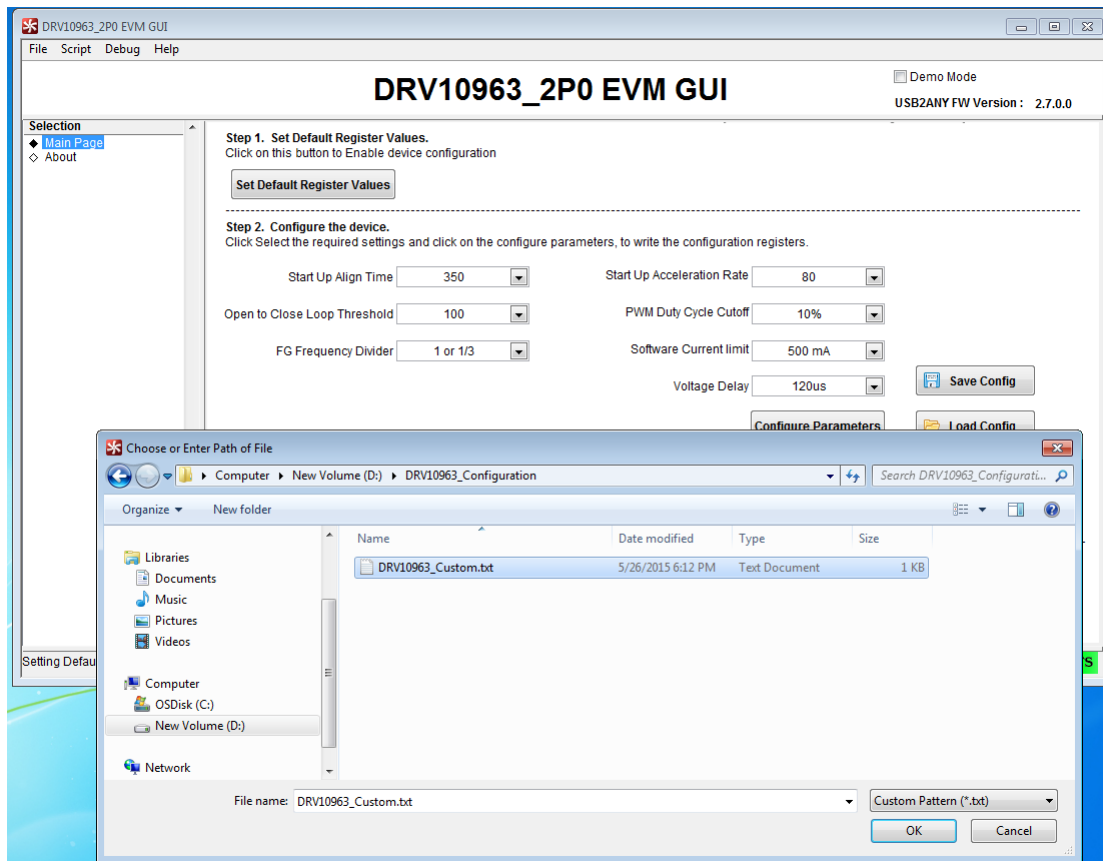

Figure 18. Load Custom Configurations to GUI

3. Increase the V_Testmode voltage level to 7.4 V and Vpower_in to 6.2 V. Now, left click "Write OTP Values" from the GUI. This will program the OTP bits of a blank device with user-configured values.

CAUTION

Never exceed Vpower_in beyond 6.5 V in any circumstances to prevent damaging the EVM.

4. In order to ensure that OTP are programmed properly, step 4 provides a means for read-back option. To enable read-back, first reduce the V_Testmode voltage level back to 6.2 V and Vpower_in to 5.0 V and left click "Read OTP Values". If the GUI does not give any error message, it ensures the correct OTP programming. This means the device is ready to be used in stand-alone mode at the end-application circuit.
5. The final test to ensure proper OTP programming, power down both power supplies, disconnect the USB2ANY. Reconnect the motor to EVM and reapply 6.2 V and 5.0 V, don't connect USB2ANY and open the jumper J1 on motherboard. The motor will start rotating confirming that the OTP are programmed and device is ready to use.

NOTE: The DRV10963 blank version is not available off-the-shelf for direct purchase, contact TI sales or distributors for further details if custom settings for production with a blank version is desired.

6.3 Reading the OTP Values

After writing the values from the shadow register to the OTP, complete step four on the GUI and read back the OTP values to make sure they are correct.

6.4 Notes

There are several issues that may occur when tuning the DRV1093 to your motor. The following sections details several common issues that could happen and how to fix them.

6.4.1 Hitting Current Limit

If the beginning of the current waveform looks like [Figure 19](#), there might be a problem with the current limitation of the chip itself. If the align time is small, the current limit of the chip is reached and the chip turns itself off, waits for a set amount of time then tries again. If you see a waveform like the one below either add a 1-Ω resistor to each one of the 3 phases or lower the V_{IN} to around 4.8 V.

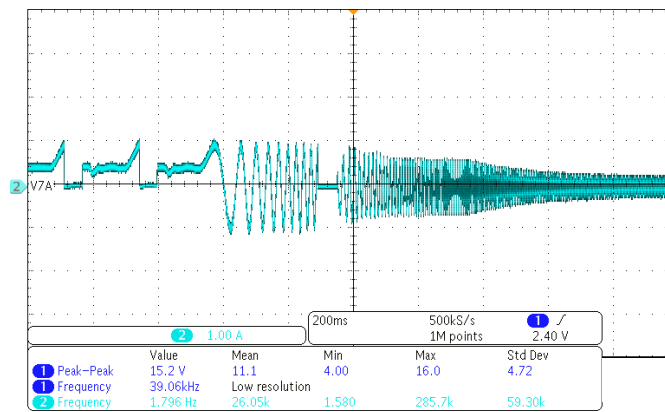

Figure 19. Motor Hitting Current Limit and Trying Again

6.4.2 Open to Close Loop Threshold High

Sometimes even though the motor will go into closed loop at a certain threshold does not mean that it is optimized. If the current waveform resembles the one shown in [Figure 20](#) before it goes into closed loop (it goes into closed loop after the flat line in the middle where the GUI is measuring the BEMF) then it means that the Open to Closed Loop Threshold is high. This is an inefficient way to start up the motor because it is dangerously close to hitting a current limit and stopping the motor waiting and trying again. The optimized performance would be to make the current funnel down until it hits closed loop control.

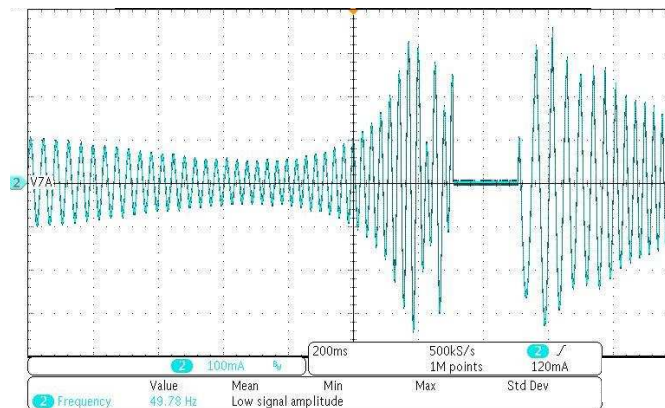

Figure 20. OTC Threshold not Optimized

6.4.3 Cannot Read Registers GUI Error

Sometimes when trying to "Set Default Register Values", the GUI will try to read the registers off of the device and cannot do so. The GUI will then throw this error message.

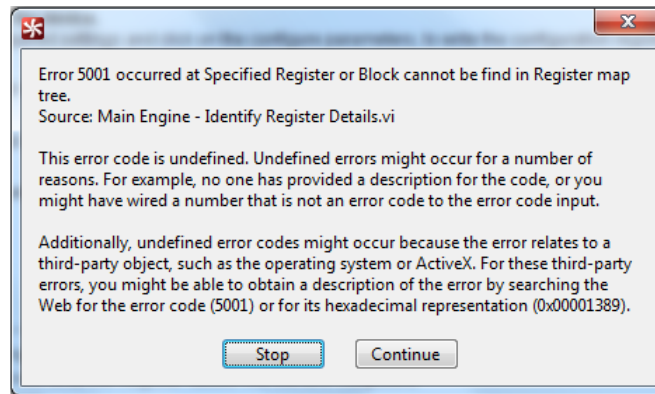

Figure 21. Register Error Message

Click continue and try again to "Set Default Register Values". It should work the second time, if all of the connections are correct from the Quick Start Guide in [Section 5](#). If not, just power cycle the EVM and restart the GUI.

7 Schematic and Bill of Materials

This section contains the DRV10983 schematic and bill of materials (BOM).

7.1 Schematic

Figure 22 shows the DRV10963 motherboard schematic.

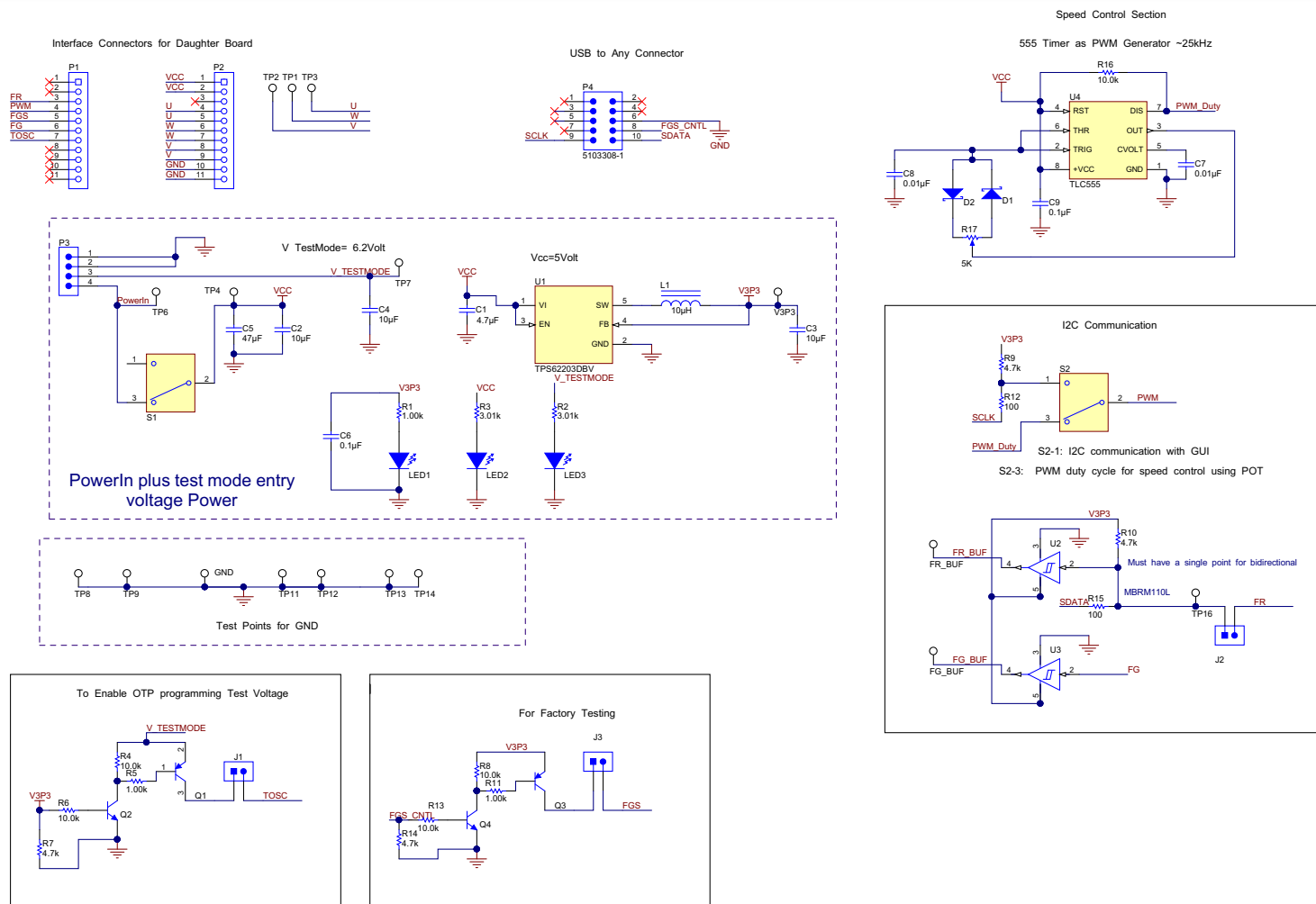

Figure 22. DRV10963 Motherboard Schematic

Figure 23 shows the DRV10963 daughterboard schematic.

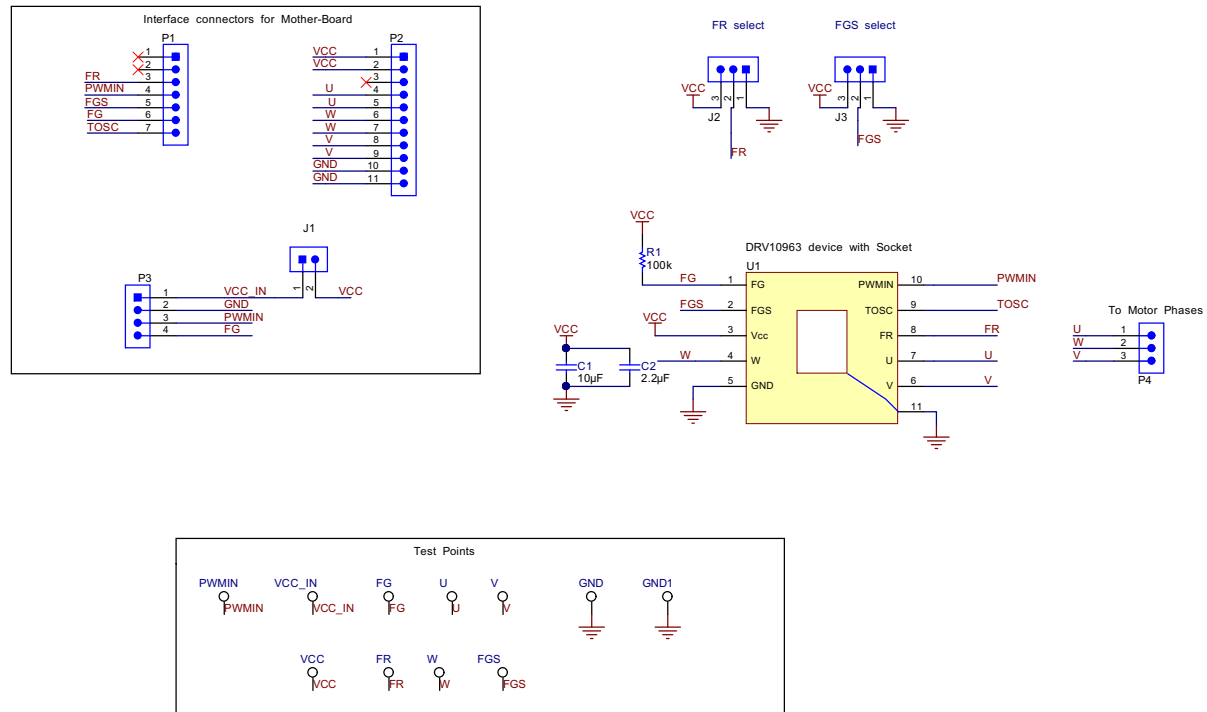

Figure 23. DRV10963 Daughterboard Schematic

7.2 Bill of Materials (BOM)

Table 5 lists the DRV10963 motherboard bill of materials.

Table 5. DRV10963 Motherboard Bill of Materials

Item #	Designator	Qty	Value	PartNumber	Manufacturer	Description	PackageReference
1	!PCB	1		MDBU001	Any	Printed Circuit Board	
2	C1	1	4.7uF	GRM21BR61C475KA88L	Murata	CAP, CERM, 4.7uF, 16V, +/-10%, X5R, 0805	0805
3	C2, C3, C4	3	10uF	GRM21BR61C106KE15L	Murata	CAP, CERM, 10uF, 16V, +/-10%, X5R, 0805	0805
4	C5	1	47uF	GRM32ER61C476KE15L	Murata	CAP, CERM, 47uF, 16V, +/-10%, X5R, 1210	1210
5	C6, C9	2	0.1uF	GRM155R71A104KA01D	Murata	CAP, CERM, 0.1uF, 10V, +/-10%, X7R, 0402	0402
6	C7, C8	2	0.01uF	C0805C103K1RACTU	Kemet	CAP, CERM, 0.01 µF, 100 V, +/- 10%, X7R, 0805	0805
7	D1, D2	2	40V	MSS1P4-M3/89A	Vishay-Siliconix	Diode, Schottky, 40 V, 1 A, MicroSMP	MicroSMP
8	FG_BUF, FR_BUF, GND, TP1, TP2, TP3, TP4, TP6, TP7, TP8, TP9, TP11, TP12, TP13, TP14, TP16, V3P3	17	SMT	5015	Keystone	Test Point, Miniature, SMT	Testpoint_Keystone_Miniature
9	FID1, FID2, FID3	3		N/A	N/A	Fiducial mark. There is nothing to buy or mount.	Fiducial
10	H1, H2, H3, H4	4		SJ-5303 (CLEAR)	3M	Bumpon, Hemisphere, 0.44 X 0.20, Clear	Transparent Bumpon
11	J1, J2, J3	3		PBC02SAAN	Sullins Connector Solutions	Header, 100mil, 2x1, Gold, TH	Sullins 100mil, 1x2, 230 mil above insulator
12	L1	1	10uH	CDRH5D18NP-100NC	Sumida	Inductor, Shielded Drum Core, Ferrite, 10uH, 1.2A, 0.124 ohm, SMD	CDRH5D18
13	LED1, LED2, LED3	3		LTST-C171GKT	Lite-On	LED, Green, SMD	LED_0805
14	P1, P2	2		BCS-111-L-S-PE	Samtec	Receptacle, 2.54mm, 11x1, Gold, TH	Receptacle, 2.54mm, 11x1, TH
15	P3	1		ED555/4DS	On-Shore Technology	Terminal Block, 6A, 3.5mm Pitch, 4-Pos, TH	14x8.2x6.5mm
16	P4	1		5103308-1	TE Connectivity	Header (shrouded), 100mil, 5x2, Gold, TH	5x2 Shrouded header
17	PCB2	1		Used in BOM report	Used in BOM report	Will add component to BOM. Useful for cables, nuts, etc. not in libraries	Used in PnP output and some BOM reports
18	Q1, Q3	2	0.25V	MMBT3906	Fairchild Semiconductor	Transistor, PNP, 40V, 0.2A, SOT-23	SOT-23
19	Q2, Q4	2	0.2V	MMBT3904	Fairchild Semiconductor	Transistor, NPN, 40V, 0.2A, SOT-23	SOT-23
20	R1, R5, R11	3	1.00k	CRCW06031K00FKEA	Vishay-Dale	RES, 1.00k ohm, 1%, 0.1W, 0603	0603
21	R2, R3	2	3.01k	CRCW06033K01FKEA	Vishay-Dale	RES, 3.01k ohm, 1%, 0.1W, 0603	0603
22	R4, R6, R8, R13	4	10.0k	CRCW060310K0FKEA	Vishay-Dale	RES, 10.0k ohm, 1%, 0.1W, 0603	0603
23	R7, R9, R10, R14	4	4.7k	CRCW06034K70JNEA	Vishay-Dale	RES, 4.7k ohm, 5%, 0.1W, 0603	0603
24	R12, R15	2	100	RC0603FR-07100RL	Yageo America	RES, 100 ohm, 1%, 0.1W, 0603	0603
25	R16	1	10.0k	CRCW080510K0FKEA	Vishay-Dale	RES, 10.0 k, 1%, 0.125 W, 0805	0805
26	R17	1	5K	296UD502B1N	CTS Electrocomponents	Trimmer, 5K Ohms, 0.15 W, TH	TH, 3-Leads, Body 12.5x12.8mm, Height 23.2mm
27	S1	1		100SP1T1B4M2QE	E-Switch	Switch, SPDT, On-On, 2 Pos, TH	12.7x6.86mm
28	S2	1		500SSP1S2M2QEA	E-Switch	Switch, SPDT, Slide, On-On, 2 Pos, TH	12.85x6.6mm

Table 5. DRV10963 Motherboard Bill of Materials (continued)

Item #	Designator	Qty	Value	PartNumber	Manufacturer	Description	PackageReference
29	SH-J1, SH-J2, SH-J3	3	1x2	SPC02SYAN	Sullins Connector Solutions	Shunt, 100mil, Flash Gold, Black	Closed Top 100mil Shunt
30	U1	1		TPS62203DBVR	Texas Instruments	HIGH-EFFICIENCY, STEP-DOWN, DC-DC CONVERTER, DBV0005A	DBV0005A
31	U2, U3	2		SN74LVC1G17DCKR	Texas Instruments	SINGLE SCHMITT-TRIGGER BUFFER, DCK0005A	DCK0005A
32	U4	1		TLC555CDR	Texas Instruments	Timer, 8-pin Narrow SOIC	M08A

Table 6 lists the DRV10963 daughterboard bill of materials.

Table 6. DRV10963 Daughterboard Bill of Materials

Item #	Designator	Qty	Value	PartNumber	Manufacturer	Description	PackageReference
1	!PCB	1		MDBU002	Any	Printed Circuit Board	
2	C1	1	10uF	GRM21BR61C106KE15L	Murata	CAP, CERM, 10uF, 16V, +/-10%, X5R, 0805	0805
3	C2	1	2.2uF	GRM188R61C225KE15D	Murata	CAP, CERM, 2.2uF, 16V, +/-10%, X5R, 0603	0603
4	FG, FGS, FR, GND, GND1, PWMIN, U, V, VCC, VCC_IN, W	11	SMT	5015	Keystone	Test Point, Miniature, SMT	Testpoint_Keystone_Miniature
5	FID1, FID2, FID3, FID4, FID5, FID6	6		N/A	N/A	Fiducial mark. There is nothing to buy or mount.	Fiducial
6	J1	1		PBC02SAAN	Sullins Connector Solutions	Header, 100mil, 2x1, Gold, TH	Sullins 100mil, 1x2, 230 mil above insulator
7	J2, J3	2		PEC03SAAN	Sullins Connector Solutions	Header, 100mil, 3x1, Tin, TH	Header, 3 PIN, 100mil, Tin
8	P1	1		PBC07SAAN	Sullins Connector Solutions	Header, 2.54 mm, 7x1, Gold, TH	Header, 2.54 mm, 7x1, TH
9	P2	1		PBC11SAAN	Sullins Connector Solutions	Header, 2.54 mm, 11x1, Gold, TH	Header, 2.54 mm, 11x1, TH
10	P3	1		PBC04SAAN	Sullins Connector Solutions	Header, 2.54 mm, 4x1, Gold, TH	Header, 2.54 mm, 4x1, TH
11	P4	1	1x3	PBC03SAAN	Sullins Connector Solutions	Header, 100mil, 3x1, Gold, TH	PBC03SAAN
12	R1	1	100k	RC0603FR-07100KL	Yageo America	RES, 100k ohm, 1%, 0.1W, 0603	0603
13	SH-J1, SH-J2, SH-J3	3	1x2	SPC02SYAN	Sullins Connector Solutions	Shunt, 100mil, Flash Gold, Black	Closed Top 100mil Shunt
14	U1	1		QFN-10(20)B-0.5-02	Enplas Tech Solutions	Socket, QFN-10, 0.5mm pitch, TH	Socket, QFN-10, 0.5mm Pitch

STANDARD TERMS AND CONDITIONS FOR EVALUATION MODULES

1. *Delivery:* TI delivers TI evaluation boards, kits, or modules, including any accompanying demonstration software, components, or documentation (collectively, an "EVM" or "EVMs") to the User ("User") in accordance with the terms and conditions set forth herein. Acceptance of the EVM is expressly subject to the following terms and conditions.
 - 1.1 EVMs are intended solely for product or software developers for use in a research and development setting to facilitate feasibility evaluation, experimentation, or scientific analysis of TI semiconductor products. EVMs have no direct function and are not finished products. EVMs shall not be directly or indirectly assembled as a part or subassembly in any finished product. For clarification, any software or software tools provided with the EVM ("Software") shall not be subject to the terms and conditions set forth herein but rather shall be subject to the applicable terms and conditions that accompany such Software
 - 1.2 EVMs are not intended for consumer or household use. EVMs may not be sold, sublicensed, leased, rented, loaned, assigned, or otherwise distributed for commercial purposes by Users, in whole or in part, or used in any finished product or production system.
2. *Limited Warranty and Related Remedies/Disclaimers:*
 - 2.1 These terms and conditions do not apply to Software. The warranty, if any, for Software is covered in the applicable Software License Agreement.
 - 2.2 TI warrants that the TI EVM will conform to TI's published specifications for ninety (90) days after the date TI delivers such EVM to User. Notwithstanding the foregoing, TI shall not be liable for any defects that are caused by neglect, misuse or mistreatment by an entity other than TI, including improper installation or testing, or for any EVMs that have been altered or modified in any way by an entity other than TI. Moreover, TI shall not be liable for any defects that result from User's design, specifications or instructions for such EVMs. Testing and other quality control techniques are used to the extent TI deems necessary or as mandated by government requirements. TI does not test all parameters of each EVM.
 - 2.3 If any EVM fails to conform to the warranty set forth above, TI's sole liability shall be at its option to repair or replace such EVM, or credit User's account for such EVM. TI's liability under this warranty shall be limited to EVMs that are returned during the warranty period to the address designated by TI and that are determined by TI not to conform to such warranty. If TI elects to repair or replace such EVM, TI shall have a reasonable time to repair such EVM or provide replacements. Repaired EVMs shall be warranted for the remainder of the original warranty period. Replaced EVMs shall be warranted for a new full ninety (90) day warranty period.
3. *Regulatory Notices:*
 - 3.1 *United States*
 - 3.1.1 *Notice applicable to EVMs not FCC-Approved:*

This kit is designed to allow product developers to evaluate electronic components, circuitry, or software associated with the kit to determine whether to incorporate such items in a finished product and software developers to write software applications for use with the end product. This kit is not a finished product and when assembled may not be resold or otherwise marketed unless all required FCC equipment authorizations are first obtained. Operation is subject to the condition that this product not cause harmful interference to licensed radio stations and that this product accept harmful interference. Unless the assembled kit is designed to operate under part 15, part 18 or part 95 of this chapter, the operator of the kit must operate under the authority of an FCC license holder or must secure an experimental authorization under part 5 of this chapter.
 - 3.1.2 *For EVMs annotated as FCC – FEDERAL COMMUNICATIONS COMMISSION Part 15 Compliant:*

CAUTION

This device complies with part 15 of the FCC Rules. Operation is subject to the following two conditions: (1) This device may not cause harmful interference, and (2) this device must accept any interference received, including interference that may cause undesired operation.

Changes or modifications not expressly approved by the party responsible for compliance could void the user's authority to operate the equipment.

FCC Interference Statement for Class A EVM devices

NOTE: This equipment has been tested and found to comply with the limits for a Class A digital device, pursuant to part 15 of the FCC Rules. These limits are designed to provide reasonable protection against harmful interference when the equipment is operated in a commercial environment. This equipment generates, uses, and can radiate radio frequency energy and, if not installed and used in accordance with the instruction manual, may cause harmful interference to radio communications. Operation of this equipment in a residential area is likely to cause harmful interference in which case the user will be required to correct the interference at his own expense.

FCC Interference Statement for Class B EVM devices

NOTE: This equipment has been tested and found to comply with the limits for a Class B digital device, pursuant to part 15 of the FCC Rules. These limits are designed to provide reasonable protection against harmful interference in a residential installation. This equipment generates, uses and can radiate radio frequency energy and, if not installed and used in accordance with the instructions, may cause harmful interference to radio communications. However, there is no guarantee that interference will not occur in a particular installation. If this equipment does cause harmful interference to radio or television reception, which can be determined by turning the equipment off and on, the user is encouraged to try to correct the interference by one or more of the following measures:

- Reorient or relocate the receiving antenna.
- Increase the separation between the equipment and receiver.
- Connect the equipment into an outlet on a circuit different from that to which the receiver is connected.
- Consult the dealer or an experienced radio/TV technician for help.

3.2 Canada

3.2.1 For EVMs issued with an Industry Canada Certificate of Conformance to RSS-210

Concerning EVMs Including Radio Transmitters:

This device complies with Industry Canada license-exempt RSS standard(s). Operation is subject to the following two conditions: (1) this device may not cause interference, and (2) this device must accept any interference, including interference that may cause undesired operation of the device.

Concernant les EVMs avec appareils radio:

Le présent appareil est conforme aux CNR d'Industrie Canada applicables aux appareils radio exempts de licence. L'exploitation est autorisée aux deux conditions suivantes: (1) l'appareil ne doit pas produire de brouillage, et (2) l'utilisateur de l'appareil doit accepter tout brouillage radioélectrique subi, même si le brouillage est susceptible d'en compromettre le fonctionnement.

Concerning EVMs Including Detachable Antennas:

Under Industry Canada regulations, this radio transmitter may only operate using an antenna of a type and maximum (or lesser) gain approved for the transmitter by Industry Canada. To reduce potential radio interference to other users, the antenna type and its gain should be so chosen that the equivalent isotropically radiated power (e.i.r.p.) is not more than that necessary for successful communication. This radio transmitter has been approved by Industry Canada to operate with the antenna types listed in the user guide with the maximum permissible gain and required antenna impedance for each antenna type indicated. Antenna types not included in this list, having a gain greater than the maximum gain indicated for that type, are strictly prohibited for use with this device.

Concernant les EVMs avec antennes détachables

Conformément à la réglementation d'Industrie Canada, le présent émetteur radio peut fonctionner avec une antenne d'un type et d'un gain maximal (ou inférieur) approuvé pour l'émetteur par Industrie Canada. Dans le but de réduire les risques de brouillage radioélectrique à l'intention des autres utilisateurs, il faut choisir le type d'antenne et son gain de sorte que la puissance isotrope rayonnée équivalente (p.i.r.e.) ne dépasse pas l'intensité nécessaire à l'établissement d'une communication satisfaisante. Le présent émetteur radio a été approuvé par Industrie Canada pour fonctionner avec les types d'antenne énumérés dans le manuel d'usage et ayant un gain admissible maximal et l'impédance requise pour chaque type d'antenne. Les types d'antenne non inclus dans cette liste, ou dont le gain est supérieur au gain maximal indiqué, sont strictement interdits pour l'exploitation de l'émetteur.

3.3 Japan

3.3.1 *Notice for EVMs delivered in Japan:* Please see http://www.tij.co.jp/lstds/ti_ja/general/eStore/notice_01.page 日本国内に輸入される評価用キット、ボードについては、次のところをご覧ください。
http://www.tij.co.jp/lstds/ti_ja/general/eStore/notice_01.page

3.3.2 *Notice for Users of EVMs Considered "Radio Frequency Products" in Japan:* EVMs entering Japan may not be certified by TI as conforming to Technical Regulations of Radio Law of Japan.

If User uses EVMs in Japan, not certified to Technical Regulations of Radio Law of Japan, User is required by Radio Law of Japan to follow the instructions below with respect to EVMs:

1. Use EVMs in a shielded room or any other test facility as defined in the notification #173 issued by Ministry of Internal Affairs and Communications on March 28, 2006, based on Sub-section 1.1 of Article 6 of the Ministry's Rule for Enforcement of Radio Law of Japan,
2. Use EVMs only after User obtains the license of Test Radio Station as provided in Radio Law of Japan with respect to EVMs, or
3. Use of EVMs only after User obtains the Technical Regulations Conformity Certification as provided in Radio Law of Japan with respect to EVMs. Also, do not transfer EVMs, unless User gives the same notice above to the transferee. Please note that if User does not follow the instructions above, User will be subject to penalties of Radio Law of Japan.

【無線電波を送信する製品の開発キットをお使いになる際の注意事項】 開発キットの中には技術基準適合証明を受けていないものがあります。技術適合証明を受けていないものご使用に際しては、電波法遵守のため、以下のいずれかの措置を取っていただく必要がありますのでご注意ください。

1. 電波法施行規則第6条第1項第1号に基づく平成18年3月28日総務省告示第173号で定められた電波暗室等の試験設備でご使用いただく。
2. 実験局の免許を取得後ご使用いただく。
3. 技術基準適合証明を取得後ご使用いただく。

なお、本製品は、上記の「ご使用にあたっての注意」を譲渡先、移転先に通知しない限り、譲渡、移転できないものとします。

上記を遵守頂けない場合は、電波法の罰則が適用される可能性があることをご留意ください。日本テキサス・インスツルメンツ株式会社
東京都新宿区西新宿 6 丁目 2 4 番 1 号
西新宿三井ビル

3.3.3 *Notice for EVMs for Power Line Communication:* Please see http://www.tij.co.jp/llds/ti_ja/general/eStore/notice_02.page
電力線搬送波通信についての開発キットをお使いになる際の注意事項については、次のところをご覧ください。http://www.tij.co.jp/llds/ti_ja/general/eStore/notice_02.page

4 *EVM Use Restrictions and Warnings:*

4.1 EVMS ARE NOT FOR USE IN FUNCTIONAL SAFETY AND/OR SAFETY CRITICAL EVALUATIONS, INCLUDING BUT NOT LIMITED TO EVALUATIONS OF LIFE SUPPORT APPLICATIONS.

4.2 User must read and apply the user guide and other available documentation provided by TI regarding the EVM prior to handling or using the EVM, including without limitation any warning or restriction notices. The notices contain important safety information related to, for example, temperatures and voltages.

4.3 *Safety-Related Warnings and Restrictions:*

4.3.1 User shall operate the EVM within TI's recommended specifications and environmental considerations stated in the user guide, other available documentation provided by TI, and any other applicable requirements and employ reasonable and customary safeguards. Exceeding the specified performance ratings and specifications (including but not limited to input and output voltage, current, power, and environmental ranges) for the EVM may cause personal injury or death, or property damage. If there are questions concerning performance ratings and specifications, User should contact a TI field representative prior to connecting interface electronics including input power and intended loads. Any loads applied outside of the specified output range may also result in unintended and/or inaccurate operation and/or possible permanent damage to the EVM and/or interface electronics. Please consult the EVM user guide prior to connecting any load to the EVM output. If there is uncertainty as to the load specification, please contact a TI field representative. During normal operation, even with the inputs and outputs kept within the specified allowable ranges, some circuit components may have elevated case temperatures. These components include but are not limited to linear regulators, switching transistors, pass transistors, current sense resistors, and heat sinks, which can be identified using the information in the associated documentation. When working with the EVM, please be aware that the EVM may become very warm.

4.3.2 EVMs are intended solely for use by technically qualified, professional electronics experts who are familiar with the dangers and application risks associated with handling electrical mechanical components, systems, and subsystems. User assumes all responsibility and liability for proper and safe handling and use of the EVM by User or its employees, affiliates, contractors or designees. User assumes all responsibility and liability to ensure that any interfaces (electronic and/or mechanical) between the EVM and any human body are designed with suitable isolation and means to safely limit accessible leakage currents to minimize the risk of electrical shock hazard. User assumes all responsibility and liability for any improper or unsafe handling or use of the EVM by User or its employees, affiliates, contractors or designees.

4.4 User assumes all responsibility and liability to determine whether the EVM is subject to any applicable international, federal, state, or local laws and regulations related to User's handling and use of the EVM and, if applicable, User assumes all responsibility and liability for compliance in all respects with such laws and regulations. User assumes all responsibility and liability for proper disposal and recycling of the EVM consistent with all applicable international, federal, state, and local requirements.

5. *Accuracy of Information:* To the extent TI provides information on the availability and function of EVMs, TI attempts to be as accurate as possible. However, TI does not warrant the accuracy of EVM descriptions, EVM availability or other information on its websites as accurate, complete, reliable, current, or error-free.

6. *Disclaimers:*

6.1 EXCEPT AS SET FORTH ABOVE, EVMS AND ANY WRITTEN DESIGN MATERIALS PROVIDED WITH THE EVM (AND THE DESIGN OF THE EVM ITSELF) ARE PROVIDED "AS IS" AND "WITH ALL FAULTS." TI DISCLAIMS ALL OTHER WARRANTIES, EXPRESS OR IMPLIED, REGARDING SUCH ITEMS, INCLUDING BUT NOT LIMITED TO ANY IMPLIED WARRANTIES OF MERCHANTABILITY OR FITNESS FOR A PARTICULAR PURPOSE OR NON-INFRINGEMENT OF ANY THIRD PARTY PATENTS, COPYRIGHTS, TRADE SECRETS OR OTHER INTELLECTUAL PROPERTY RIGHTS.

6.2 EXCEPT FOR THE LIMITED RIGHT TO USE THE EVM SET FORTH HEREIN, NOTHING IN THESE TERMS AND CONDITIONS SHALL BE CONSTRUED AS GRANTING OR CONFERRING ANY RIGHTS BY LICENSE, PATENT, OR ANY OTHER INDUSTRIAL OR INTELLECTUAL PROPERTY RIGHT OF TI, ITS SUPPLIERS/LICENSORS OR ANY OTHER THIRD PARTY, TO USE THE EVM IN ANY FINISHED END-USER OR READY-TO-USE FINAL PRODUCT, OR FOR ANY INVENTION, DISCOVERY OR IMPROVEMENT MADE, CONCEIVED OR ACQUIRED PRIOR TO OR AFTER DELIVERY OF THE EVM.

7. *USER'S INDEMNITY OBLIGATIONS AND REPRESENTATIONS.* USER WILL DEFEND, INDEMNIFY AND HOLD TI, ITS LICENSORS AND THEIR REPRESENTATIVES HARMLESS FROM AND AGAINST ANY AND ALL CLAIMS, DAMAGES, LOSSES, EXPENSES, COSTS AND LIABILITIES (COLLECTIVELY, "CLAIMS") ARISING OUT OF OR IN CONNECTION WITH ANY HANDLING OR USE OF THE EVM THAT IS NOT IN ACCORDANCE WITH THESE TERMS AND CONDITIONS. THIS OBLIGATION SHALL APPLY WHETHER CLAIMS ARISE UNDER STATUTE, REGULATION, OR THE LAW OF TORT, CONTRACT OR ANY OTHER LEGAL THEORY, AND EVEN IF THE EVM FAILS TO PERFORM AS DESCRIBED OR EXPECTED.

8. *Limitations on Damages and Liability:*

8.1 *General Limitations.* IN NO EVENT SHALL TI BE LIABLE FOR ANY SPECIAL, COLLATERAL, INDIRECT, PUNITIVE, INCIDENTAL, CONSEQUENTIAL, OR EXEMPLARY DAMAGES IN CONNECTION WITH OR ARISING OUT OF THESE TERMS AND CONDITIONS OR THE USE OF THE EVMS PROVIDED HEREUNDER, REGARDLESS OF WHETHER TI HAS BEEN ADVISED OF THE POSSIBILITY OF SUCH DAMAGES. EXCLUDED DAMAGES INCLUDE, BUT ARE NOT LIMITED TO, COST OF REMOVAL OR REINSTALLATION, ANCILLARY COSTS TO THE PROCUREMENT OF SUBSTITUTE GOODS OR SERVICES, RETESTING, OUTSIDE COMPUTER TIME, LABOR COSTS, LOSS OF GOODWILL, LOSS OF PROFITS, LOSS OF SAVINGS, LOSS OF USE, LOSS OF DATA, OR BUSINESS INTERRUPTION. NO CLAIM, SUIT OR ACTION SHALL BE BROUGHT AGAINST TI MORE THAN ONE YEAR AFTER THE RELATED CAUSE OF ACTION HAS OCCURRED.

8.2 *Specific Limitations.* IN NO EVENT SHALL TI'S AGGREGATE LIABILITY FROM ANY WARRANTY OR OTHER OBLIGATION ARISING OUT OF OR IN CONNECTION WITH THESE TERMS AND CONDITIONS, OR ANY USE OF ANY TI EVM PROVIDED HEREUNDER, EXCEED THE TOTAL AMOUNT PAID TO TI FOR THE PARTICULAR UNITS SOLD UNDER THESE TERMS AND CONDITIONS WITH RESPECT TO WHICH LOSSES OR DAMAGES ARE CLAIMED. THE EXISTENCE OF MORE THAN ONE CLAIM AGAINST THE PARTICULAR UNITS SOLD TO USER UNDER THESE TERMS AND CONDITIONS SHALL NOT ENLARGE OR EXTEND THIS LIMIT.

9. *Return Policy.* Except as otherwise provided, TI does not offer any refunds, returns, or exchanges. Furthermore, no return of EVM(s) will be accepted if the package has been opened and no return of the EVM(s) will be accepted if they are damaged or otherwise not in a resalable condition. If User feels it has been incorrectly charged for the EVM(s) it ordered or that delivery violates the applicable order, User should contact TI. All refunds will be made in full within thirty (30) working days from the return of the components(s), excluding any postage or packaging costs.

10. *Governing Law:* These terms and conditions shall be governed by and interpreted in accordance with the laws of the State of Texas, without reference to conflict-of-laws principles. User agrees that non-exclusive jurisdiction for any dispute arising out of or relating to these terms and conditions lies within courts located in the State of Texas and consents to venue in Dallas County, Texas. Notwithstanding the foregoing, any judgment may be enforced in any United States or foreign court, and TI may seek injunctive relief in any United States or foreign court.

IMPORTANT NOTICE

Texas Instruments Incorporated and its subsidiaries (TI) reserve the right to make corrections, enhancements, improvements and other changes to its semiconductor products and services per JESD46, latest issue, and to discontinue any product or service per JESD48, latest issue. Buyers should obtain the latest relevant information before placing orders and should verify that such information is current and complete. All semiconductor products (also referred to herein as "components") are sold subject to TI's terms and conditions of sale supplied at the time of order acknowledgment.

TI warrants performance of its components to the specifications applicable at the time of sale, in accordance with the warranty in TI's terms and conditions of sale of semiconductor products. Testing and other quality control techniques are used to the extent TI deems necessary to support this warranty. Except where mandated by applicable law, testing of all parameters of each component is not necessarily performed.

TI assumes no liability for applications assistance or the design of Buyers' products. Buyers are responsible for their products and applications using TI components. To minimize the risks associated with Buyers' products and applications, Buyers should provide adequate design and operating safeguards.

TI does not warrant or represent that any license, either express or implied, is granted under any patent right, copyright, mask work right, or other intellectual property right relating to any combination, machine, or process in which TI components or services are used. Information published by TI regarding third-party products or services does not constitute a license to use such products or services or a warranty or endorsement thereof. Use of such information may require a license from a third party under the patents or other intellectual property of the third party, or a license from TI under the patents or other intellectual property of TI.

Reproduction of significant portions of TI information in TI data books or data sheets is permissible only if reproduction is without alteration and is accompanied by all associated warranties, conditions, limitations, and notices. TI is not responsible or liable for such altered documentation. Information of third parties may be subject to additional restrictions.

Resale of TI components or services with statements different from or beyond the parameters stated by TI for that component or service voids all express and any implied warranties for the associated TI component or service and is an unfair and deceptive business practice. TI is not responsible or liable for any such statements.

Buyer acknowledges and agrees that it is solely responsible for compliance with all legal, regulatory and safety-related requirements concerning its products, and any use of TI components in its applications, notwithstanding any applications-related information or support that may be provided by TI. Buyer represents and agrees that it has all the necessary expertise to create and implement safeguards which anticipate dangerous consequences of failures, monitor failures and their consequences, lessen the likelihood of failures that might cause harm and take appropriate remedial actions. Buyer will fully indemnify TI and its representatives against any damages arising out of the use of any TI components in safety-critical applications.

In some cases, TI components may be promoted specifically to facilitate safety-related applications. With such components, TI's goal is to help enable customers to design and create their own end-product solutions that meet applicable functional safety standards and requirements. Nonetheless, such components are subject to these terms.

No TI components are authorized for use in FDA Class III (or similar life-critical medical equipment) unless authorized officers of the parties have executed a special agreement specifically governing such use.

Only those TI components which TI has specifically designated as military grade or "enhanced plastic" are designed and intended for use in military/aerospace applications or environments. Buyer acknowledges and agrees that any military or aerospace use of TI components which have **not** been so designated is solely at the Buyer's risk, and that Buyer is solely responsible for compliance with all legal and regulatory requirements in connection with such use.

TI has specifically designated certain components as meeting ISO/TS16949 requirements, mainly for automotive use. In any case of use of non-designated products, TI will not be responsible for any failure to meet ISO/TS16949.

Products

Audio	www.ti.com/audio
Amplifiers	amplifier.ti.com
Data Converters	dataconverter.ti.com
DLP® Products	www.dlp.com
DSP	dsp.ti.com
Clocks and Timers	www.ti.com/clocks
Interface	interface.ti.com
Logic	logic.ti.com
Power Mgmt	power.ti.com
Microcontrollers	microcontroller.ti.com
RFID	www.ti-rfid.com
OMAP Applications Processors	www.ti.com/omap
Wireless Connectivity	www.ti.com/wirelessconnectivity

Applications

Automotive and Transportation	www.ti.com/automotive
Communications and Telecom	www.ti.com/communications
Computers and Peripherals	www.ti.com/computers
Consumer Electronics	www.ti.com/consumer-apps
Energy and Lighting	www.ti.com/energy
Industrial	www.ti.com/industrial
Medical	www.ti.com/medical
Security	www.ti.com/security
Space, Avionics and Defense	www.ti.com/space-avionics-defense
Video and Imaging	www.ti.com/video

TI E2E Community

e2e.ti.com