

GloTek, Inc. www.globtek.com 186 Veterans Drive, Northvale, NJ 07647 Tel. (201) 784-1000 Fax (201) 784-0111	Drawing Title: GTM961600P16019-T3, Medical/ICT/ITE/Household use Power Supply, Efficiency Level: USA DOE Level VI / Eco-design Directive 2009/125/EC, (EU) 2019/1782, Case Color/Style: GloTek Black, Desktop/External, Regulated Switchmode AC-DC Power Supply AC Adaptor, Input Rating: 100-240V~, 50-60 Hz, IEC 60320/C14 , Output Rating: 160W, 19.0V@8.42A, Output Configuration: 1200 mm, 14/1C + Shield Cond, UL 1185, 4 Pin Locking Kycon or Equal, Ferrite: None, GloTek Black, GT Cord # C21421, Pin Out: Pin 2,4: +V, Pin 1,3, Shell: -V, Blades/Input Cord: (Order Separately), Approvals: cETLus; CB 60601-1-11; CB 60601-1; cETLus; S-Mark IEC/EN 60601-1; EAC; Korea (12-13.5V Only); CB 60950; CB 60335; cETLus 60601-1 3rd; Korea (18V Only); UKCA; Conforms to 62368-1; CCC; CB 62368; S-Mark 60950; ETL 62368; FCC; CAN ICES-3; Morocco; RCM; Korea(24-30V Only); IRAM; NOM (12V only); FCC; GEMS (12V); HKSM; Saudi (pending); Taiwan BSMI (12,15,18,19,24,48 and 54V); CE; RoHS; China RoHS; Ukraine; WEEE; VCCI; Class I; Level VI; PSE; PSE; PSE;	
	Model No. GTM961600P16019-T3	
	Part No./Ordering No. TR9CZ8421YL4IMR6B	Rev B

In Addition to GloTek Inc.'s renewed ISO9001:2015 - Quality Management System Certification, GloTek Inc. is now certified to:

ISO13485:2016 - Medical Devices Quality Management System Certification

ISO14001:2015 - Environmental Management System Certification

ISO Certificates are available online at <https://www.globtek.com/iso-certificates/>

The acceptance of this specification and use of the product described in this document indicates the acceptance and binding of the customer to GloTek TERMS AND CONDITIONS (attached to the end of this document), which supersede all other agreements, terms, and conditions (<https://en.globtek.com/terms-and-conditions/>).

The purchaser of this product (Customer) agrees that it is their sole responsibility to determine suitability/fitness of the product described in this specification for their application and to take precautions for protection against any hazards attendant to the handling and use of the product.

Footnote:

GloTek Inc. will not be liable for the safety and performance of these power supplies/battery packs if unauthorized access and repair occurs. End user should consult applicable UL, CSA or EN standards for proper installation instruction.

Limitation of Use:

GloTek products are intended for use with commercial, medical, and/or industrial equipment only. GloTek product are not authorized for use as mission critical components in life support hazardous environment, nuclear or aircraft applications without prior written approval from the CEO of GloTek Inc.

Contents of this document are subject to change without prior notice.

Customer Approval of Specification:

Please approve, sign and send back to GloTek so we can complete order processing.

A delay in receipt of this form will delay delivery schedule.

Company Name: _____	Customer P/N: _____
Quote Number: _____	Date: _____
Authorized Representative Name: _____	Authorized Representative Signature: _____

GlobTek, Inc. www.globtek.com 186 Veterans Drive, Northvale, NJ 07647 Tel. (201) 784-1000 Fax (201) 784-0111	Drawing Title: GTM961600P16019-T3, Medical/ICT/ITE/Household use Power Supply, Efficiency Level: USA DOE Level VI / Eco-design Directive 2009/125/EC, (EU) 2019/1782, Case Color/Style: GlobTek Black, Desktop/External, Regulated Switchmode AC-DC Power Supply AC Adaptor, Input Rating: 100-240V~, 50-60 Hz, IEC 60320/C14 , Output Rating: 160W, 19.0V@8.42A, Output Configuration: 1200 mm, 14/1C + Shield Cond, UL 1185, 4 Pin Locking Kycon or Equal, Ferrite: None, GlobTek Black, GT Cord # C21421, Pin Out: Pin 2,4: +V, Pin 1,3, Shell: -V, Blades/Input Cord: (Order Separately), Approvals: cETLus; CB 60601-1-11; CB 60601-1; cETLus; S-Mark IEC/EN 60601-1; EAC; Korea (12-13.5V Only); CB 60950; CB 60335; cETLus 60601-1 3rd; Korea (18V Only); UKCA; Conforms to 62368-1; CCC; CB 62368; S-Mark 60950; ETL 62368; FCC; CAN ICES-3; Morocco; RCM; Korea(24-30V Only); IRAM; NOM (12V only); FCC; GEMS (12V); HKSM; Saudi (pending); Taiwan BSMI (12,15,18,19,24,48 and 54V); CE; RoHS; China RoHS; Ukraine; WEEE; VCCI; Class I; Level VI; PSE; PSE; PSE;	
	Model No. GTM961600P16019-T3	
	Part No./Ordering No. TR9CZ8421YL4IMR6B	Rev B

REVISION HISTORY

REV	DESCRIPTION	SUB	DATE	APPROVED
B	Update O/P cord to UL1185 14AWG (from YL4/C21419 to YL4/C21421)	QA	12/18/2018	QA
A	Initial release	QA	07/08/2018	QA

POWER SUPPLY INFORMATION

TYPE:	Desktop/External
TECHNOLOGY:	Regulated Switchmode AC-DC Power Supply AC Adaptor
CASE COLOR:	GlobTek Black
NAMEPLATE RATED INPUT:	100-240V~, 50-60 Hz, 2.2A
INPUT CONFIG:	IEC 60320/C14
WATTS:	160.0
VOLTS OUT:	19.0
CURRENT OUT (Amps):	8.42
BLADE/CORD INCLUDED:	None (Order Separately)
BLADE/CORD INSTALLED:	None :(Order Separately)
INGRESS PROTECTION:	IP41
GROUNDING CONFIGURATION:	(F2) Isolated Functional Earth for GTM96 series, Improved EMC
EFFICIENCY LEVEL:	USA DOE Level VI / Eco-design Directive 2009/125/EC, (EU) 2019/1782
OUTPUT CONFIGURATION:	1200 mm, 14/1C + Shield Cond, UL 1185, 4 Pin Locking Kycon or Equal, Ferrite: None, GlobTek Black, GT Cord # C21421
OVERMOLDED:	Yes
OUTPUT CONNECTOR GENDER:	Male
CONNECTOR PIN OUT:	Pin 2,4: +V, Pin 1,3, Shell: -V
LABEL SPECS:	Standard GT,L-1186
SPECIAL BARCODE LABEL MATERIAL:	No
PACK SPEC:	Standard DT, Cellular packaging, User manual
USER MANUAL:	809-DESKTOPUSERMANUAL on A4 paper

PROPRIETARY INFORMATION

GlobTek, Inc. www.globtek.com 186 Veterans Drive, Northvale, NJ 07647 Tel. (201) 784-1000 Fax (201) 784-0111	Drawing Title: GTM961600P16019-T3, Medical/ICT/ITE/Household use Power Supply, Efficiency Level: USA DOE Level VI / Eco-design Directive 2009/125/EC, (EU) 2019/1782, Case Color/Style: GlobTek Black, Desktop/External, Regulated Switchmode AC-DC Power Supply AC Adaptor, Input Rating: 100-240V~, 50-60 Hz, IEC 60320/C14 , Output Rating: 160W, 19.0V@8.42A, Output Configuration: 1200 mm, 14/1C + Shield Cond, UL 1185, 4 Pin Locking Kycon or Equal, Ferrite: None, GlobTek Black, GT Cord # C21421, Pin Out: Pin 2,4: +V, Pin 1,3, Shell: -V, Blades/Input Cord: (Order Separately), Approvals: cETLus; CB 60601-1-11; CB 60601-1; cETLus; S-Mark IEC/EN 60601-1; EAC; Korea (12-13.5V Only); CB 60950; CB 60335; cETLus 60601-1 3rd; Korea (18V Only); UKCA; Conforms to 62368-1; CCC; CB 62368; S-Mark 60950; ETL 62368; FCC; CAN ICES-3; Morocco; RCM; Korea(24-30V Only); IRAM; NOM (12V only); FCC; GEMS (12V); HKSM; Saudi (pending); Taiwan BSMI (12,15,18,19,24,48 and 54V); CE; RoHS; China RoHS; Ukraine; WEEE; VCCI; Class I; Level VI; PSE; PSE; PSE;	
	Model No. GTM961600P16019-T3	
	Part No./Ordering No. TR9CZ8421YL4IMR6B	Rev B

Notes/Modifications/Customizations (notes in this section supersede the values shown in the standard spec):
DIMENSIONS ARE IN MM UNLESS SPECIFIED OTHERWISE.

GloBtek, Inc. www.globtek.com 186 Veterans Drive, Northvale, NJ 07647 Tel. (201) 784-1000 Fax (201) 784-0111	Drawing Title: GTM961600P16019-T3, Medical/ICT/ITE/Household use Power Supply, Efficiency Level: USA DOE Level VI / Eco-design Directive 2009/125/EC, (EU) 2019/1782, Case Color/Style: GloBtek Black, Desktop/External, Regulated Switchmode AC-DC Power Supply AC Adaptor, Input Rating: 100-240V~, 50-60 Hz, IEC 60320/C14, Output Rating: 160W, 19.0V@8.42A, Output Configuration: 1200 mm, 14/1C + Shield Cond, UL 1185, 4 Pin Locking Kycon or Equal, Ferrite: None, GloBtek Black, GT Cord # C21421, Pin Out: Pin 2,4: +V, Pin 1,3, Shell: -V, Blades/Input Cord: (Order Separately), Approvals: cETLus; CB 60601-1-11; CB 60601-1; cETLus; S-Mark IEC/EN 60601-1; EAC; Korea (12-13.5V Only); CB 60950; CB 60335; cETLus 60601-1 3rd; Korea (18V Only); UKCA; Conforms to 62368-1; CCC; CB 62368; S-Mark 60950; ETL 62368; FCC; CAN ICES-3; Morocco; RCM; Korea(24-30V Only); IRAM; NOM (12V only); FCC; GEMS (12V); HKSM; Saudi (pending); Taiwan BSMI (12,15,18,19,24,48 and 54V); CE; RoHS; China RoHS; Ukraine; WEEE; VCCI; Class I; Level VI; PSE; PSE; PSE;	
	Model No. GTM961600P16019-T3	
	Part No./Ordering No. TR9CZ8421YL4IMR6B	Rev B

ELECTRICAL SPECIFICATIONS

A) ELECTRICAL SPECIFICATIONS:

01. Input Voltage: Specified 90-264 Vac, Nameplate rated: 100-240Vac
90-264Vac range @ 100% of rated load current
85-264 Vac range @ 90% of rated load current
02. Input Frequency: Specified 47-63 Hz, Nameplate rated 50/60Hz
03. Power Factor: 0.90 minimum @ 230Vac, 0.97 minimum @ 115Vac
04. Output Regulation: +/- 4% max measured at the output connector
05. Line Voltage Regulation: +/- 0.5% typical measured at full load
06. Green Power On Indicator LED
07. Output Ripple (Vp-p): 1% or 200 mV whichever is greater, measured at 20 MHz bandwidth with 0.1 uF ceramic capacitor in parallel with a low impedance 47 uF electrolytic capacitor connected at the end of the output connector at nominal line
08. Turn-ON/OFF Overshoot: 5% maximum, 1 mS typical recovery time for 25% to 50% step load
09. Turn-ON Delay: 1 second typical
10. Hold-Up Time: 20 mS minimum
11. Inrush Current: 30A maximum at 115Vac input and 60A maximum at 230Vac input
12. Switching Frequency: Varies from 25KHz to 125KHz
13. Efficiency: Compliant with DoE Efficiency Level VI standard and CoC Tier 2
14. No Load Standby Power: <0.15 W @ 230Vac

B) PROTECTION

01. Input Protection: Input line fusing and 300Vac rated MOV
02. Short Circuit/ Overload: Electronically Protected unit will auto recover upon removal of fault
Output Current Limit: Current limited to less than 240W / Vnom and 18A for low voltage models
(Vnom = nominal rated output voltage)
03. Over-Temperature: Latching Electronic Overtemperature protection. Cycle AC OFF to reset.
04. Output Over-Voltage: 110% to 135% of nominal output voltage under full load condition, and less than 60V max. Latching protection, cycle AC OFF to reset.

C) SAFETY

01. Dielectric Withstand Voltage: 4000Vac or 5656Vdc from input to output,
On Class I models, 3000Vac or 4242Vdc from input to earth
02. Earth Leakage Current: Class I models < 300uA, N/A for Class II models
03. Touch Current: Class I models < 20uA, Class II models < 70uA
04. [Output Isolation Options](#):
a) C8 or C18 Inlet, Class II
b) C6 or C14 Inlet, Class II FE, Output Isolated from Earth contact
c) C6 or C14 Inlet, Class I, Output negative directly attached to Earth contact
05. Earth Continuity Test: < 0.1 Ohm between Earth Pin at AC input and PCB termination point (Class I models only)
06. Means of Protection: 2 x MOPP
07. Primary to Secondary Bridging Capacitance: Two IEC60384-14 certified Y1 type capacitors in series
08. Compliant Standards: See listings at end of this drawing for specifics

D) EMC

EN 60601-1-2, 4th edition
Emissions, per EN 55032, EN 61000-6-3, EN 61000-6-4, CISPR11 and CISPR22

PROPRIETARY INFORMATION

GlobTek, Inc. www.globtek.com 186 Veterans Drive, Northvale, NJ 07647 Tel. (201) 784-1000 Fax (201) 784-0111	Drawing Title: GTM961600P16019-T3, Medical/ICT/ITE/Household use Power Supply, Efficiency Level: USA DOE Level VI / Eco-design Directive 2009/125/EC, (EU) 2019/1782, Case Color/Style: GlobTek Black, Desktop/External, Regulated Switchmode AC-DC Power Supply AC Adaptor, Input Rating: 100-240V~, 50-60 Hz, IEC 60320/C14, Output Rating: 160W, 19.0V@8.42A, Output Configuration: 1200 mm, 14/1C + Shield Cond, UL 1185, 4 Pin Locking Kycon or Equal, Ferrite: None, GlobTek Black, GT Cord # C21421, Pin Out: Pin 2,4: +V, Pin 1,3, Shell: -V, Blades/Input Cord: (Order Separately), Approvals: cETLus; CB 60601-1-11; CB 60601-1; cETLus; S-Mark IEC/EN 60601-1; EAC; Korea (12-13.5V Only); CB 60950; CB 60335; cETLus 60601-1 3rd; Korea (18V Only); UKCA; Conforms to 62368-1; CCC; CB 62368; S-Mark 60950; ETL 62368; FCC; CAN ICES-3; Morocco; RCM; Korea(24-30V Only); IRAM; NOM (12V only); FCC; GEMS (12V); HKSM; Saudi (pending); Taiwan BSMI (12,15,18,19,24,48 and 54V); CE; RoHS; China RoHS; Ukraine; WEEE; VCCI; Class I; Level VI; PSE; PSE; PSE;	
	Model No. GTM961600P16019-T3	
	Part No./Ordering No. TR9CZ8421YL4IMR6B	Rev B

Conducted Emissions: Class B, FCC Part 15, Class B

Radiated Emissions: Class B, FCC Part 15, Class B

Line Frequency Harmonics EN61000-3-2, Class A

Voltage Fluctuations/Flicker EN61000-3-3

Immunity, per EN 55024, EN 61000-6-1, EN 61000-6-2

Static Discharge Immunity EN61000-4-2, 10kV Contact Discharge, 18kV air discharge

Radiated RF Immunity EN61000-4-3, 10V/m 80-2.7GHz, 80% 1KHz AM.

EFT/Burst Immunity EN61000-4-4, 4kV/100kHz.

Line Surge Immunity EN61000-4-5, 2kV differential, 4kV common-mode

Conducted RF Immunity EN61000-4-6, 3Vrms, 80% 1KHz AM

Power Frequency Magnetic Field Immunity EN61000-4-8, 3A/m

Voltage Dip Immunity EN61000-4-11, Criteria

E) OTHER:

01. MTBF: 1,000,000 Hours @ 40°C ambient temperature, Full Load

02. Operating Temperature: -10°C to 40°C ambient temperature with full load

Regarding Operating Temperature,

a- See below derating table for output power capability at alternate temperature

b- Extended low end temperature range down to -40°C available as a custom option

03. Humidity: 0% to 95% relative humidity, non-condensing

04. Storage Temperature: -30°C to 80°C

05. Cooling: Convection

06. ROHS: Compliant with latest regulations, see approvals section below

07. Operational Altitude: 5000M

F) DESKTOP STYLE ENCLOSURE

01. Housing: High impact plastic, 94V0 polycarbonate, non-vented

02. Size: 176.5 x 74 x 40 +/-1.0 mm

03. Markings: Label or Laser printed

04. AC Input mechanical options: Desktop C6, C8, C14 or C18 IEC Inlet.

G) SPECIAL OPTIONS

01. Custom Cordsets, various cordage types, and connector types

02. Custom Markings

03. Short term Output Surge Power Capability, for motor applications, and short term intermittent high power need applications. 300W for 1 second is available, as a special design variant.

04. Reduced Leakage Current version, medical CF leakage current compliance

05. Tightened output voltage tolerance

06. Reduced Output Ripple Level

08. Reduced output power marking/rating

09. High Rel PCB laminate with Plated through Holes for IPC610 Class 2 Compliance

10. Special Housing Colors and Cordset Colors

11. LED Lighting Applications, Class C Line Harmonics

12. Constant Current output, for V_{nom} to $0.75 \times V_{nom}$. Add "-CC" suffix to model number. Current level is custom selectable.

13. Back EMF applications, custom solutions. For unusual motor load apps and other high inductance reverse energy flow requirements

14. Improved Ingress Protection Rating

PROPRIETARY INFORMATION

PROPRIETARY OF GLOBTEK, INC. ANY REPRODUCTION, DISCLOSURE OR USE OF THIS DRAWING, IN WHOLE OR IN PART, IS HEREBY PROHIBITED EXCEPT AS SPECIFIED IN WRITING BY GLOBTEK, INC. © GlobTek, Inc. 2018 - 2022

quest/09/20/2022 12:40:49 AM CLONED FROM TR9C16666MF6C1MR6B

GlobTek, Inc. www.globtek.com 186 Veterans Drive, Northvale, NJ 07647 Tel. (201) 784-1000 Fax (201) 784-0111	Drawing Title: GTM961600P16019-T3, Medical/ICT/ITE/Household use Power Supply, Efficiency Level: USA DOE Level VI / Eco-design Directive 2009/125/EC, (EU) 2019/1782, Case Color/Style: GlobTek Black, Desktop/External, Regulated Switchmode AC-DC Power Supply AC Adaptor, Input Rating: 100-240V~, 50-60 Hz, IEC 60320/C14 , Output Rating: 160W, 19.0V@8.42A, Output Configuration: 1200 mm, 14/1C + Shield Cond, UL 1185, 4 Pin Locking Kycon or Equal, Ferrite: None, GlobTek Black, GT Cord # C21421, Pin Out: Pin 2,4: +V, Pin 1,3, Shell: -V, Blades/Input Cord: (Order Separately), Approvals: cETLus; CB 60601-1-11; CB 60601-1; cETLus; S-Mark IEC/EN 60601-1; EAC; Korea (12-13.5V Only); CB 60950; CB 60335; cETLus 60601-1 3rd; Korea (18V Only); UKCA; Conforms to 62368-1; CCC; CB 62368; S-Mark 60950; ETL 62368; FCC; CAN ICES-3; Morocco; RCM; Korea(24-30V Only); IRAM; NOM (12V only); FCC; GEMS (12V); HKSM; Saudi (pending); Taiwan BSMI (12,15,18,19,24,48 and 54V); CE; RoHS; China RoHS; Ukraine; WEEE; VCCI; Class I; Level VI; PSE; PSE; PSE;	
	Model No. GTM961600P16019-T3	
	Part No./Ordering No. TR9CZ8421YL4IMR6B	Rev B

H) OUTPUT CONNECTORS

Several output connector options are available with various output current ratings.

GlobTek can supply 10A rated 2.1mm and 2.5mm style DC Power Jacks, to complement our

10A output rated 2.1mm and 2.5mm DC power plugs used on our output cordsets.

Please visit <https://en.globtek.com/news/high-current-coaxial-barrel-plug-jacks-for-high-wattage-power-supplies> for a real time product offering of mating connectors.

TO ADDRESS SYSTEM-LEVEL EMI CONCERNS, FERRITE CHOKES/BEADS MAY BE ADDED/REVISED UPON REQUEST. A SAMPLE KIT OF GLOBTEK'S STANDARD FERRITES IS AVAILABLE UNDER GLOBTEK P/N: EMI-MITIGATION-KIT1

FOR ADDITIONAL INFORMATION, PLEASE READ OUR WHITE PAPER AT:

<https://en.globtek.com/technical-articles/ferrite-kit-radiated-emi-suppression-kit-for-globtek-power-supplies-cable-assemblies>

INGRESS PROTECTION: IP41

<p>GlobTek, Inc. www.globtek.com 186 Veterans Drive, Northvale, NJ 07647 Tel. (201) 784-1000 Fax (201) 784-0111</p>	<p>Drawing Title: GTM961600P16019-T3, Medical/ICT/ITE/Household use Power Supply, Efficiency Level: USA DOE Level VI / Eco-design Directive 2009/125/EC, (EU) 2019/1782, Case Color/Style: GlobTek Black, Desktop/External, Regulated Switchmode AC-DC Power Supply AC Adaptor, Input Rating: 100-240V~, 50-60 Hz, IEC 60320/C14 , Output Rating: 160W, 19.0V@8.42A, Output Configuration: 1200 mm, 14/1C + Shield Cond, UL 1185, 4 Pin Locking Kycon or Equal, Ferrite: None, GlobTek Black, GT Cord # C21421, Pin Out: Pin 2,4: +V, Pin 1,3, Shell: -V, Blades/Input Cord: (Order Separately), Approvals: cETLus; CB 60601-1-11; CB 60601-1; cETLus; S-Mark IEC/EN 60601-1; EAC; Korea (12-13.5V Only); CB 60950; CB 60335; cETLus 60601-1 3rd; Korea (18V Only); UKCA; Conforms to 62368-1; CCC; CB 62368; S-Mark 60950; ETL 62368; FCC; CAN ICES-3; Morocco; RCM; Korea(24-30V Only); IRAM; NOM (12V only); FCC; GEMS (12V); HKSM; Saudi (pending); Taiwan BSMI (12,15,18,19,24,48 and 54V); CE; RoHS; China RoHS; Ukraine; WEEE; VCCI; Class I; Level VI; PSE; PSE; PSE;</p> <p>Model No. GTM961600P16019-T3</p>	<p>Part No./Ordering No. TR9CZ8421YL4IMR6B</p> <p>Rev B</p>
--	---	---

3D File Download <https://www.globtek.com/dl/GTM961600-GTM961800-T3.igs>

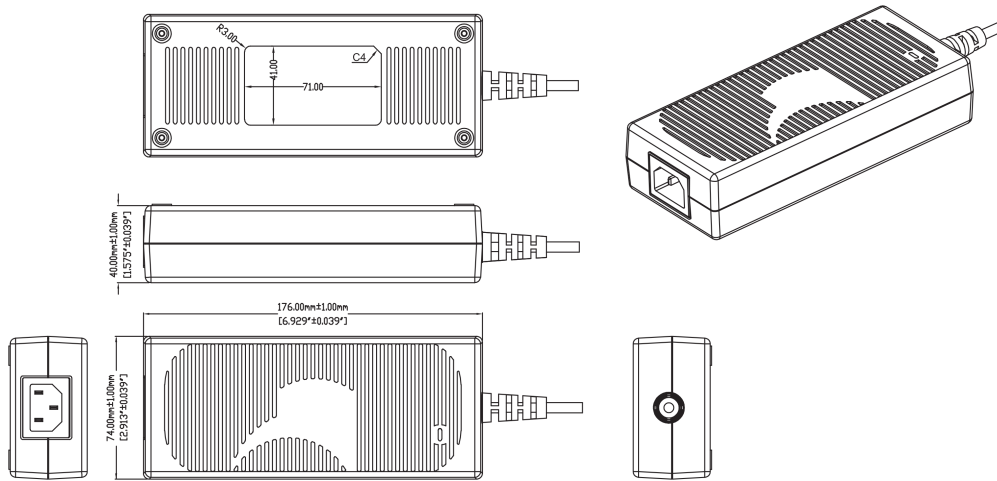

PROPRIETARY INFORMATION

PROPRIETARY OF GLOBTEK, INC. ANY REPRODUCTION, DISCLOSURE OR USE OF THIS DRAWING, IN WHOLE OR IN PART, IS HEREBY PROHIBITED EXCEPT AS SPECIFIED IN WRITING BY GLOBTEK, INC. © GlobTek, Inc. 2018 - 2022

<p>GlobTek, Inc. www.globtek.com 186 Veterans Drive, Northvale, NJ 07647 Tel. (201) 784-1000 Fax (201) 784-0111</p>	<p>Drawing Title: GTM961600P16019-T3, Medical/ICT/ITE/Household use Power Supply, Efficiency Level: USA DOE Level VI / Eco-design Directive 2009/125/EC, (EU) 2019/1782, Case Color/Style: GlobTek Black, Desktop/External, Regulated Switchmode AC-DC Power Supply AC Adaptor, Input Rating: 100-240V~, 50-60 Hz, IEC 60320/C14, Output Rating: 160W, 19.0V@8.42A, Output Configuration: 1200 mm, 14/1C + Shield Cond, UL 1185, 4 Pin Locking Kycon or Equal, Ferrite: None, GlobTek Black, GT Cord # C21421, Pin Out: Pin 2,4: +V, Pin 1,3, Shell: -V, Blades/Input Cord: (Order Separately), Approvals: cETLus; CB 60601-1-11; CB 60601-1; cETLus; S-Mark IEC/EN 60601-1; EAC; Korea (12-13.5V Only); CB 60950; CB 60335; cETLus 60601-1 3rd; Korea (18V Only); UKCA; Conforms to 62368-1; CCC; CB 62368; S-Mark 60950; ETL 62368; FCC; CAN ICES-3; Morocco; RCM; Korea(24-30V Only); IRAM; NOM (12V only); FCC; GEMS (12V); HKSM; Saudi (pending); Taiwan BSMI (12,15,18,19,24,48 and 54V); CE; RoHS; China RoHS; Ukraine; WEEE; VCCI; Class I; Level VI; PSE; PSE; PSE;</p>	
	<p>Model No. GTM961600P16019-T3</p>	
	<p>Part No./Ordering No. TR9CZ8421YL4IMR6B</p>	<p>Rev B</p>

DERATING CURVE

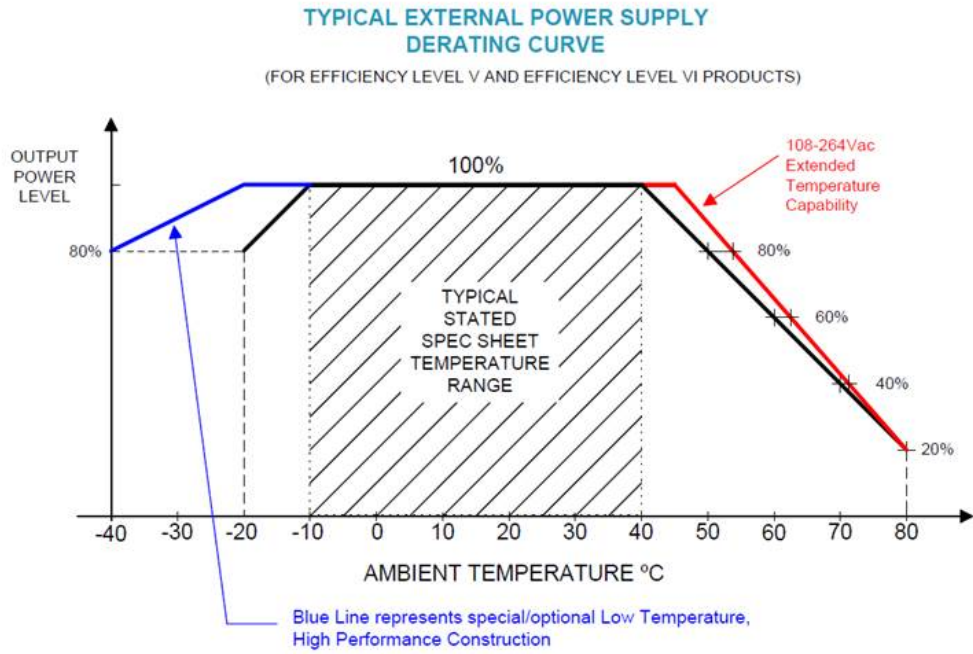

GlobTek, Inc. www.globtek.com 186 Veterans Drive, Northvale, NJ 07647 Tel. (201) 784-1000 Fax (201) 784-0111	Drawing Title: GTM961600P16019-T3, Medical/ICT/ITE/Household use Power Supply, Efficiency Level: USA DOE Level VI / Eco-design Directive 2009/125/EC, (EU) 2019/1782, Case Color/Style: GlobTek Black, Desktop/External, Regulated Switchmode AC-DC Power Supply AC Adaptor, Input Rating: 100-240V~, 50-60 Hz, IEC 60320/C14 , Output Rating: 160W, 19.0V@8.42A, Output Configuration: 1200 mm, 14/1C + Shield Cond, UL 1185, 4 Pin Locking Kycon or Equal, Ferrite: None, GlobTek Black, GT Cord # C21421, Pin Out: Pin 2,4: +V, Pin 1,3, Shell: -V, Blades/Input Cord: (Order Separately), Approvals: cETLus; CB 60601-1-11; CB 60601-1; cETLus; S-Mark IEC/EN 60601-1; EAC; Korea (12-13.5V Only); CB 60950; CB 60335; cETLus 60601-1 3rd; Korea (18V Only); UKCA; Conforms to 62368-1; CCC; CB 62368; S-Mark 60950; ETL 62368; FCC; CAN ICES-3; Morocco; RCM; Korea(24-30V Only); IRAM; NOM (12V only); FCC; GEMS (12V); HKSM; Saudi (pending); Taiwan BSMI (12,15,18,19,24,48 and 54V); CE; RoHS; China RoHS; Ukraine; WEEE; VCCI; Class I; Level VI; PSE; PSE; PSE;	
	Model No. GTM961600P16019-T3	
	Part No./Ordering No. TR9CZ8421YL4IMR6B	Rev B

INPUT CONFIGURATION

(F2) Isolated Functional Earth for GTM96 series, Improved EMC

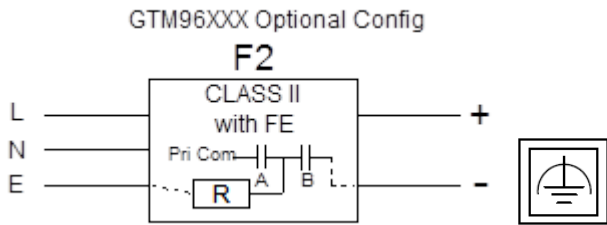

[Alternate grounding configurations](#) available upon request.

Blades/Cord Included:None:(Order Separately)

Blades/Cord Installed:None:(Order Separately)

IEC 60320/C14 AC Inlet Connector, Class I, Earth Ground

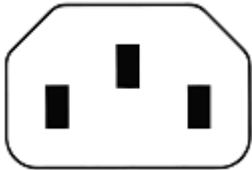

Mates with IEC 60320/C13 Plug

Optional Locking IEC60320 Receptacle and cord option available on some models by request.:



[Standard International IEC 320/C13 Cordsets](#)

Below are standard cordsets which are "not included" (unless stated above); these can be purchased separately or packaged with the power supply. Contact your Sales Engineer if the style required is not shown below. Many more available in different lengths, colors or cable material.

GlobTek, Inc. www.globtek.com 186 Veterans Drive, Northvale, NJ 07647 Tel. (201) 784-1000 Fax (201) 784-0111	Drawing Title: GTM961600P16019-T3, Medical/ICT/ITE/Household use Power Supply, Efficiency Level: USA DOE Level VI / Eco-design Directive 2009/125/EC, (EU) 2019/1782, Case Color/Style: GlobTek Black, Desktop/External, Regulated Switchmode AC-DC Power Supply AC Adaptor, Input Rating: 100-240V~, 50-60 Hz, IEC 60320/C14, Output Rating: 160W, 19.0V@8.42A, Output Configuration: 1200 mm, 14/1C + Shield Cond, UL 1185, 4 Pin Locking Kycon or Equal, Ferrite: None, GlobTek Black, GT Cord # C21421, Pin Out: Pin 2,4: +V, Pin 1,3, Shell: -V, Blades/Input Cord: (Order Separately), Approvals: cETLus; CB 60601-1-11; CB 60601-1; cETLus; S-Mark IEC/EN 60601-1; EAC; Korea (12-13.5V Only); CB 60950; CB 60335; cETLus 60601-1 3rd; Korea (18V Only); UKCA; Conforms to 62368-1; CCC; CB 62368; S-Mark 60950; ETL 62368; FCC; CAN ICES-3; Morocco; RCM; Korea(24-30V Only); IRAM; NOM (12V only); FCC; GEMS (12V); HKSM; Saudi (pending); Taiwan BSMI (12,15,18,19,24,48 and 54V); CE; RoHS; China RoHS; Ukraine; WEEE; VCCI; Class I; Level VI; PSE; PSE; PSE;	
	Model No. GTM961600P16019-T3	
	Part No./Ordering No. TR9CZ8421YL4IMR6B	Rev B

Stock Power Supply Cords

Part Number/ Link	Country	Plug	Termination	Length (mm)	(Ft)
3021457F701(R)	N. American (Type B)	NEMA 5-15P	IEC 320/C13	2150	7
1191068F0701(R)	N. American (Type B)	NEMA 5-15P Hospital	IEC 320/C13	2459	8
2194272M5701-T(R)	Argentina (Type I)	IRAM 2073	IEC 320/C13	2500	8
5502022M5701A(R)	Australian (Type I)	AS3112 / 3 PRONG	IEC 320/C13	2500	8
204B4272M5701(R)	Brazil (Type N)	BRAZIL	IEC 320/C13	2500	8
6023602M5701(R)	China (Type I)	CCC GR2099	IEC 320/C13	2500	8
G8014272M5701(R)	Danish (Type K)	AFSNIT SECTION 107-2-D1	IEC 320/C13	2500	8
23144272M5701-T(R)	Europe (Type E)	CEE 7/7	IEC 320/C13	2500	8
23134272M5701EUKR(R)	Europe/Korea Combo (Type E)	CEE 7/7 / KSC8305	IEC 320/C13	2500	8
205IN4272M5701(R)	India (Type D)	India IS 1293 (also known as IA16A3 or BS546)	IEC 320/C13	2500	8
208IN4272M5701(R)	India (Type M)	India IS 1293 (also known as IA16A3 or BS546)	IEC320/C13	2500	8
377C4272M5701(R)	Israel (Type H)	ISL 377C	IEC 320/C13	2500	8
23024272M5701(R)	Italy (Type L)	CEI 23-16/VII	IEC 320/C13	2500	8
3003339F701(R) [3x1.25mm2]	Japan (Type B)	JIS 8303 / 3 PINS	IEC 320/C13	2500	8
3003068F2701-HK(R) [3 x 2.0mm2]					
302J115J6F0701J(R)	North America / Japan (Type B - 12A)	NEMA 5-15P (cULus approved), Japan JIS C 8303 (PSE Approved)	IEC 320/C13	1830	6
302J104J6F0701J(R)	North America / Japan (Type B - 15A)	NEMA 5-15P (cULus approved), Japan JIS C 8303 (PSE Approved)	IEC 320/C13	1830	6
302JT104J9F0701JT(R)	North America / Japan / Taiwan (Type B - 15A)	NEMA 5-15P (cULus approved), Japan JIS C 8303 (PSE Approved), Taiwan CNS 6797 (BSMI Approved)	IEC 320/C13	2800	9
2313K3432M5701(R)	Korea (Type F)	KS C 8305	IEC 320/C13	2500	8

PROPRIETARY INFORMATION

<p>GlobTek, Inc. www.globtek.com 186 Veterans Drive, Northvale, NJ 07647 Tel. (201) 784-1000 Fax (201) 784-0111</p>	<p>Drawing Title: GTM961600P16019-T3, Medical/ICT/ITE/Household use Power Supply, Efficiency Level: USA DOE Level VI / Eco-design Directive 2009/125/EC, (EU) 2019/1782, Case Color/Style: GlobTek Black, Desktop/External, Regulated Switchmode AC-DC Power Supply AC Adaptor, Input Rating: 100-240V~, 50-60 Hz, IEC 60320/C14 , Output Rating: 160W, 19.0V@8.42A, Output Configuration: 1200 mm, 14/1C + Shield Cond, UL 1185, 4 Pin Locking Kycon or Equal, Ferrite: None, GlobTek Black, GT Cord # C21421, Pin Out: Pin 2,4: +V, Pin 1,3, Shell: -V, Blades/Input Cord: (Order Separately), Approvals: cETLus; CB 60601-1-11; CB 60601-1; cETLus; S-Mark IEC/EN 60601-1; EAC; Korea (12-13.5V Only); CB 60950; CB 60335; cETLus 60601-1 3rd; Korea (18V Only); UKCA; Conforms to 62368-1; CCC; CB 62368; S-Mark 60950; ETL 62368; FCC; CAN ICES-3; Morocco; RCM; Korea(24-30V Only); IRAM; NOM (12V only); FCC; GEMS (12V); HKSM; Saudi (pending); Taiwan BSMI (12,15,18,19,24,48 and 54V); CE; RoHS; China RoHS; Ukraine; WEEE; VCCI; Class I; Level VI; PSE; PSE; PSE;</p>	
	<p>Model No. GTM961600P16019-T3</p>	
	<p>Part No./Ordering No. TR9CZ8421YL4IMR6B</p>	<p>Rev B</p>

5804272M5701(R)	Russia (Type F)	GOST 7396	IEC 320/C13	2500	8
2084272M5701(R)	South Africa (Type M)	South Africa SABS164-1 (16A type)	IEC 320/C13	2500	8
23214272M5701(R)	Switzerland (Type J)	SEV 1011	IEC 320/C13	2500	8
3003322M5701(R)	Taiwan (Type B)	BSMI	IEC 320/C13	2500	8
6363762M5701(R)	Thailand (Type O)	TIS 166-2549	IEC 320/C13	2500	8
PZ0800100-2M5BK13H(R)	UK, Hong Kong, Singapore, Gulf States (Type G)	BS 1363A	IEC 320/C13	2500	8
7055002M5701A(R)	International	IEC 320 C14-C13	IEC 320/C13	2500	8

GlobTek, Inc. www.globtek.com 186 Veterans Drive, Northvale, NJ 07647 Tel. (201) 784-1000 Fax (201) 784-0111	Drawing Title: GTM961600P16019-T3, Medical/ICT/ITE/Household use Power Supply, Efficiency Level: USA DOE Level VI / Eco-design Directive 2009/125/EC, (EU) 2019/1782, Case Color/Style: GlobTek Black, Desktop/External, Regulated Switchmode AC-DC Power Supply AC Adaptor, Input Rating: 100-240V~, 50-60 Hz, IEC 60320/C14, Output Rating: 160W, 19.0V@8.42A, Output Configuration: 1200 mm, 14/1C + Shield Cond, UL 1185, 4 Pin Locking Kycon or Equal, Ferrite: None, GlobTek Black, GT Cord # C21421, Pin Out: Pin 2,4: +V, Pin 1,3, Shell: -V, Blades/Input Cord: (Order Separately), Approvals: cETLus; CB 60601-1-11; CB 60601-1; cETLus; S-Mark IEC/EN 60601-1; EAC; Korea (12-13.5V Only); CB 60950; CB 60335; cETLus 60601-1 3rd; Korea (18V Only); UKCA; Conforms to 62368-1; CCC; CB 62368; S-Mark 60950; ETL 62368; FCC; CAN ICES-3; Morocco; RCM; Korea(24-30V Only); IRAM; NOM (12V only); FCC; GEMS (12V); HKSM; Saudi (pending); Taiwan BSMI (12,15,18,19,24,48 and 54V); CE; RoHS; China RoHS; Ukraine; WEEE; VCCI; Class I; Level VI; PSE; PSE; PSE;	
	Model No. GTM961600P16019-T3	
	Part No./Ordering No. TR9CZ8421YL4IMR6B	Rev B

OUTPUT CORD AND CONNECTOR: YL4/C21421

ACTUAL CONNECTORS, OVERMOLDS, FERRITES MAY VARY SLIGHTLY FROM THE PICTURE BELOW

CABLE TYPE	UL 1185
CABLE LENGTH (mm)	1200
CABLE TOLERANCE (mm)	+100, -0
WIRE GAUGE (AWG)	14
CONDUCTORS	1C + Shield
HANK DIMENSION (mm)	120 ± 10
CABLE / CONNECTOR OVERMOLD COLOR	GlobTek Black
FERRITE TYPE / DIMENSION	None
FERRITE # OF TURNS (Definition)	N/A
FERRITE DIMENSION FROM STRAIN RELIEF	N/A
FERRITE DIMENSION FROM PLUG	N/A
PLUG TYPE	4 Pin Locking Kycon or Equal
OUTPUT CONNECTOR GENDER	Male
OVERMOLDED	Yes
OVER MOLD ORIENTATION	Straight
CONNECTOR PIN OUT:	Pin 2,4: +V, Pin 1,3, Shell: -V
ADDITIONAL REQUIREMENTS	

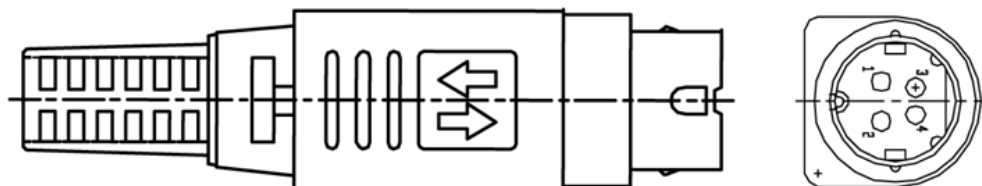

Please visit <https://en.globtek.com/news/power-din-locking-connector-cable-assemblies-and-accessories> for Power Din connector mating jacks (Shielded and unshielded), inline mating plugs, and extension cables in various custom and standard lengths available from stock in both black and white.

ADDITIONAL OUTPUT PLUG OPTIONS ARE AVAILABLE AT <https://www.globtek.com/connectors/>
STANDARD PLUGS AND CONNECTORS CAN BE SEEN ONLINE AT <https://www.globtek.com/connectors/>
CALCULATE VOLTAGE REGULATION/DROP WITH OUR ONLINE CALCULATOR: <https://en.globtek.com/output-cable-regulation-calculator/>

GlobTek, Inc. www.globtek.com 186 Veterans Drive, Northvale, NJ 07647 Tel. (201) 784-1000 Fax (201) 784-0111	Drawing Title: GTM961600P16019-T3, Medical/ICT/ITE/Household use Power Supply, Efficiency Level: USA DOE Level VI / Eco-design Directive 2009/125/EC, (EU) 2019/1782, Case Color/Style: GlobTek Black, Desktop/External, Regulated Switchmode AC-DC Power Supply AC Adaptor, Input Rating: 100-240V~, 50-60 Hz, IEC 60320/C14 , Output Rating: 160W, 19.0V@8.42A, Output Configuration: 1200 mm, 14/1C + Shield Cond, UL 1185, 4 Pin Locking Kycon or Equal, Ferrite: None, GlobTek Black, GT Cord # C21421, Pin Out: Pin 2,4: +V, Pin 1,3, Shell: -V, Blades/Input Cord: (Order Separately), Approvals: cETLus; CB 60601-1-11; CB 60601-1; cETLus; S-Mark IEC/EN 60601-1; EAC; Korea (12-13.5V Only); CB 60950; CB 60335; cETLus 60601-1 3rd; Korea (18V Only); UKCA; Conforms to 62368-1; CCC; CB 62368; S-Mark 60950; ETL 62368; FCC; CAN ICES-3; Morocco; RCM; Korea(24-30V Only); IRAM; NOM (12V only); FCC; GEMS (12V); HKSM; Saudi (pending); Taiwan BSMI (12,15,18,19,24,48 and 54V); CE; RoHS; China RoHS; Ukraine; WEEE; VCCI; Class I; Level VI; PSE; PSE; PSE;	
	Model No. GTM961600P16019-T3	
	Part No./Ordering No. TR9CZ8421YL4IMR6B	Rev B

OUTPUT CONNECTOR HOOK UP

TO ADDRESS SYSTEM-LEVEL EMI CONCERNS, FERRITE CHOKES/BEADS MAY BE ADDED/REVISED UPON REQUEST. A SAMPLE KIT OF GLOBTEK'S STANDARD FERRITES IS AVAILABLE UNDER GLOBTEK P/N: EMI-MITIGATION-KIT1

FOR ADDITIONAL INFORMATION, PLEASE READ OUR WHITE PAPER AT:

<https://en.globtek.com/technical-articles/ferrite-kit-radiated-emi-suppression-kit-for-globtek-power-supplies-cable-assemblies>

GlobTek, Inc. www.globtek.com 186 Veterans Drive, Northvale, NJ 07647 Tel. (201) 784-1000 Fax (201) 784-0111	Drawing Title: GTM961600P16019-T3, Medical/ICT/ITE/Household use Power Supply, Efficiency Level: USA DOE Level VI / Eco-design Directive 2009/125/EC, (EU) 2019/1782, Case Color/Style: GlobTek Black, Desktop/External, Regulated Switchmode AC-DC Power Supply AC Adaptor, Input Rating: 100-240V~, 50-60 Hz, IEC 60320/C14, Output Rating: 160W, 19.0V@8.42A, Output Configuration: 1200 mm, 14/1C + Shield Cond, UL 1185, 4 Pin Locking Kycon or Equal, Ferrite: None, GlobTek Black, GT Cord # C21421, Pin Out: Pin 2,4: +V, Pin 1,3, Shell: -V, Blades/Input Cord: (Order Separately), Approvals: cETLus; CB 60601-1-11; CB 60601-1; cETLus; S-Mark IEC/EN 60601-1; EAC; Korea (12-13.5V Only); CB 60950; CB 60335; cETLus 60601-1 3rd; Korea (18V Only); UKCA; Conforms to 62368-1; CCC; CB 62368; S-Mark 60950; ETL 62368; FCC; CAN ICES-3; Morocco; RCM; Korea(24-30V Only); IRAM; NOM (12V only); FCC; GEMS (12V); HKSM; Saudi (pending); Taiwan BSMI (12,15,18,19,24,48 and 54V); CE; RoHS; China RoHS; Ukraine; WEEE; VCCI; Class I; Level VI; PSE; PSE; PSE;
	Model No. GTM961600P16019-T3
	Part No./Ordering No. TR9CZ8421YL4IMR6B Rev B

LABEL:L-1186

LABEL P/N:	Standard GT
MATERIAL:	Flat Thermal Transfer, Imprintable, Polyester Label and/or Pad Printed and/or Molded, and/or Laser Engraved in the case
BACKGROUND COLOR:	Black if housing is Black, White or Silver if housing is White or Gray.
TEXT COLOR:	White or Silver if label is Black Background for Black housing. Black if label is White or Silver background and Housing is White or Gray.
LABEL WIDTH (mm):	41
LABEL HEIGHT (mm):	71
SPECIAL BARCODE LABEL MATERIAL:	No

Below is the minimum information which will appear on the label. NOTE: in the logo area additional/actual positioning of symbols and text is subjected to change as per agency updates/requirements or additional model approvals become available. Regulatory certifications/label markings may be in logo area on the label or molded into the case housing outside the label area. Information will be shown via label and/or pad printed and/or molded and/or laser engraved in the case. * Date code markings at GlobTek option

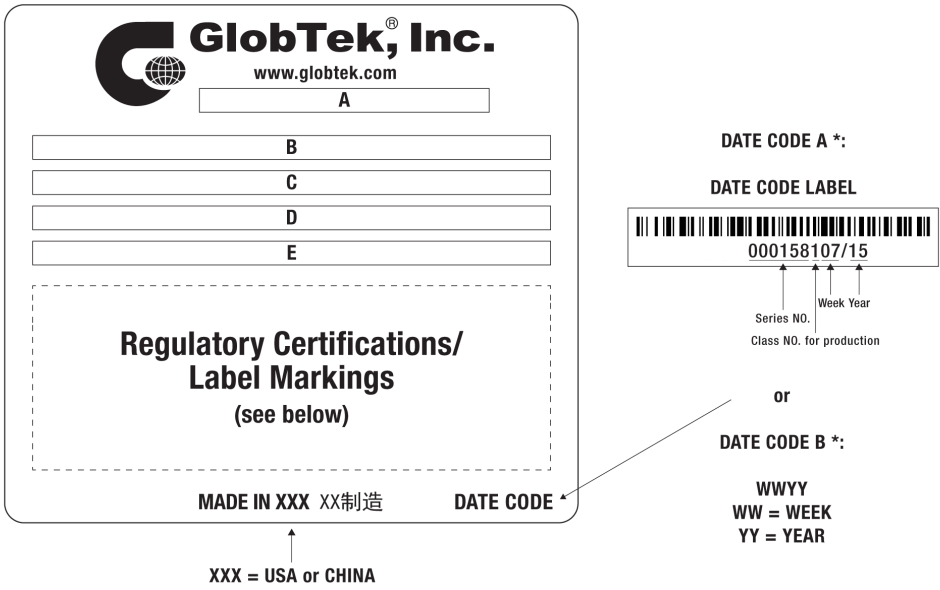

- A=Medical/ICT/ITE/Household use Power Supply
- B=P/N: (料号) TR9CZ8421YL4IMR6B
- C=Model (型号) GTM961600P16019-T3
- D=Input (输入)100-240V~, 50-60 Hz, 2.2A
- E=Output (输出)19.0 V \equiv 8.42 A, 160.0W

GloBtek, Inc. www.globtek.com 186 Veterans Drive, Northvale, NJ 07647 Tel. (201) 784-1000 Fax (201) 784-0111	Drawing Title: GTM961600P16019-T3, Medical/ICT/ITE/Household use Power Supply, Efficiency Level: USA DOE Level VI / Eco-design Directive 2009/125/EC, (EU) 2019/1782, Case Color/Style: GloBtek Black, Desktop/External, Regulated Switchmode AC-DC Power Supply AC Adaptor, Input Rating: 100-240V~, 50-60 Hz, IEC 60320/C14 , Output Rating: 160W, 19.0V@8.42A, Output Configuration: 1200 mm, 14/1C + Shield Cond, UL 1185, 4 Pin Locking Kycon or Equal, Ferrite: None, GloBtek Black, GT Cord # C21421, Pin Out: Pin 2,4: +V, Pin 1,3, Shell: -V, Blades/Input Cord: (Order Separately), Approvals: cETLus; CB 60601-1-11; CB 60601-1; cETLus; S-Mark IEC/EN 60601-1; EAC; Korea (12-13.5V Only); CB 60950; CB 60335; cETLus 60601-1 3rd; Korea (18V Only); UKCA; Conforms to 62368-1; CCC; CB 62368; S-Mark 60950; ETL 62368; FCC; CAN ICES-3; Morocco; RCM; Korea(24-30V Only); IRAM; NOM (12V only); FCC; GEMS (12V); HKSM; Saudi (pending); Taiwan BSMI (12,15,18,19,24,48 and 54V); CE; RoHS; China RoHS; Ukraine; WEEE; VCCI; Class I; Level VI; PSE; PSE; PSE;	
	Model No. GTM961600P16019-T3	
	Part No./Ordering No. TR9CZ8421YL4IMR6B	Rev B

AGENCY ONLINE DOCUMENTS	http://www.globtek.info/certs/GTM961800P/
CE EC-Declaration for Medical	http://globtek.force.com/models/ec_declaration_product?id=01t0c000008P8xe&m=1
CE EC-Declaration for Industrial/Commercial/ITE	http://globtek.force.com/models/ec_declaration_product?id=01t0c000008P8xe&i=2
CE EC-Declaration for Household	http://globtek.force.com/models/ec_declaration_product?id=01t0c000008P8xe&h=2
UKCA-Declaration for Medical	http://globtek.force.com/models/ukca_declaration_product?id=01t0c000008P8xe&m=1
UKCA-Declaration for Industrial/Commercial/ITE	http://globtek.force.com/models/ukca_declaration_product?id=01t0c000008P8xe&i=2
UKCA-Declaration for Household	http://globtek.force.com/models/ukca_declaration_product?id=01t0c000008P8xe&h=2
Morocco SDoC Declaration	https://globtek.secure.force.com/models/Morocco_SDoC_Declaration?id=a0Oa000000MmF9hEAF
RoHS/RoHS3 Declaration	https://www.globtek.com/pdf/rohs_cert/01t0c000008P8xeAAC
REACH Declaration	https://www.globtek.com/pdf/iso_certificates/REACH.pdf
Conflict Minerals Declaration	https://www.globtek.com/pdf/conflict-minerals.pdf
Prop 65 Statement	https://en.globtek.com/prop-65-statement.pdf

IPXY rating is based on 3rd party testing and customers should check suitability and test system level IPXY rating before ordering.

Regulatory Certifications/Label Markings

Below follows a link to the latest regulatory certifications and marks for this specific product. National standards as well as certification schemes are constantly changing and so is the set of certification marks and symbols applicable to this product. Various standards, marks and symbols, and certificates are subject to change at any time without notice.

Additional standards or unique country certifications are available upon request. Please contact GloBtek to request a quotation.

LATEST PRODUCT/MODEL CERTIFICATIONS: <https://www.globtek.com/datasheet/w71085>

AGENCY ONLINE DOCUMENTS: <http://www.globtek.info/certs/GTM961800P/>



(F2) Isolated Functional Earth for GTM96 series, Improved EMC

Front View



Pin 2,4: +V, Pin 1,3, Shell: -V

GloTek, Inc. www.globtek.com 186 Veterans Drive, Northvale, NJ 07647 Tel. (201) 784-1000 Fax (201) 784-0111	Drawing Title: GTM961600P16019-T3, Medical/ICT/ITE/Household use Power Supply, Efficiency Level: USA DOE Level VI / Eco-design Directive 2009/125/EC, (EU) 2019/1782, Case Color/Style: GlobTek Black, Desktop/External, Regulated Switchmode AC-DC Power Supply AC Adaptor, Input Rating: 100-240V~, 50-60 Hz, IEC 60320/C14 , Output Rating: 160W, 19.0V@8.42A, Output Configuration: 1200 mm, 14/1C + Shield Cond, UL 1185, 4 Pin Locking Kycon or Equal, Ferrite: None, GlobTek Black, GT Cord # C21421, Pin Out: Pin 2,4: +V, Pin 1,3, Shell: -V, Blades/Input Cord: (Order Separately), Approvals: cETLus; CB 60601-1-11; CB 60601-1; cETLus; S-Mark IEC/EN 60601-1; EAC; Korea (12-13.5V Only); CB 60950; CB 60335; cETLus 60601-1 3rd; Korea (18V Only); UKCA; Conforms to 62368-1; CCC; CB 62368; S-Mark 60950; ETL 62368; FCC; CAN ICES-3; Morocco; RCM; Korea(24-30V Only); IRAM; NOM (12V only); FCC; GEMS (12V); HKSM; Saudi (pending); Taiwan BSMI (12,15,18,19,24,48 and 54V); CE; RoHS; China RoHS; Ukraine; WEEE; VCCI; Class I; Level VI; PSE; PSE; PSE;	
	Model No. GTM961600P16019-T3	
	Part No./Ordering No. TR9CZ8421YL4IMR6B	Rev B

PACKAGING

Packing Spec P/N:	Standard DT, Cellular packaging, User manual
Box Qty:	20
Gift Box Size (mm):	Cellular Packaging
Gift Box Color:	None
Master Carton Size (mm):	450 x 461 x 182
Master Carton Cubic Volume (m³):	0.04
Master GW (Kg):	16.0 kg
BLADES INCLUDED:	None: (Order Separately)
BLADE/CORD INSTALLED:	None: (Order Separately)
USER MANUAL*:	809-DESKTOPUSERMANUAL on A4 paper
USER MANUAL WEB LINK:	https://en.globtek.com/pdf/809-DESKTOPUSERMANUAL.jpg

* This specification sheet is considered the user manual for all applications. It is expected that the buyer of this product will use it to formulate their own user manual for their end product and a user manual specifically for the power adapter is not usually required. If a user manual is not specifically listed above then none will be provided with this unit.

If specific packaging is required, this section must specify all requirements and note "no exceptions". If this section does not specify packaging, it is subject to change without notice at GlobTek's discretion.

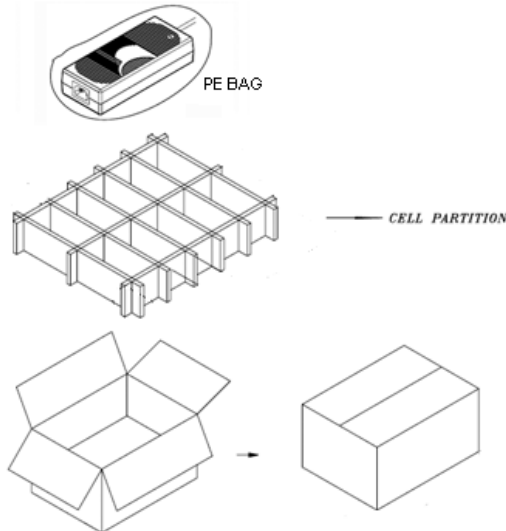

PROPRIETARY INFORMATION

<p>GlobTek, Inc. www.globtek.com 186 Veterans Drive, Northvale, NJ 07647 Tel. (201) 784-1000 Fax (201) 784-0111</p>	<p>Drawing Title: GTM961600P16019-T3, Medical/ICT/ITE/Household use Power Supply, Efficiency Level: USA DOE Level VI / Eco-design Directive 2009/125/EC, (EU) 2019/1782, Case Color/Style: GlobTek Black, Desktop/External, Regulated Switchmode AC-DC Power Supply AC Adaptor, Input Rating: 100-240V~, 50-60 Hz, IEC 60320/C14 , Output Rating: 160W, 19.0V@8.42A, Output Configuration: 1200 mm, 14/1C + Shield Cond, UL 1185, 4 Pin Locking Kycon or Equal, Ferrite: None, GlobTek Black, GT Cord # C21421, Pin Out: Pin 2,4: +V, Pin 1,3, Shell: -V, Blades/Input Cord: (Order Separately), Approvals: cETLus; CB 60601-1-11; CB 60601-1; cETLus; S-Mark IEC/EN 60601-1; EAC; Korea (12-13.5V Only); CB 60950; CB 60335; cETLus 60601-1 3rd; Korea (18V Only); UKCA; Conforms to 62368-1; CCC; CB 62368; S-Mark 60950; ETL 62368; FCC; CAN ICES-3; Morocco; RCM; Korea(24-30V Only); IRAM; NOM (12V only); FCC; GEMS (12V); HKSM; Saudi (pending); Taiwan BSMI (12,15,18,19,24,48 and 54V); CE; RoHS; China RoHS; Ukraine; WEEE; VCCI; Class I; Level VI; PSE; PSE; PSE;</p>
	<p>Model No. GTM961600P16019-T3</p>
	<p>Part No./Ordering No. TR9CZ8421YL4IMR6B</p>
	<p>Rev B</p>



GlobTek, Inc. www.globtek.com 186 Veterans Drive, Northvale, NJ 07647 Tel. (201) 784-1000 Fax (201) 784-0111	Drawing Title: GTM961600P16019-T3, Medical/ICT/ITE/Household use Power Supply, Efficiency Level: USA DOE Level VI / Eco-design Directive 2009/125/EC, (EU) 2019/1782, Case Color/Style: GlobTek Black, Desktop/External, Regulated Switchmode AC-DC Power Supply AC Adaptor, Input Rating: 100-240V~, 50-60 Hz, IEC 60320/C14 , Output Rating: 160W, 19.0V@8.42A, Output Configuration: 1200 mm, 14/1C + Shield Cond, UL 1185, 4 Pin Locking Kycon or Equal, Ferrite: None, GlobTek Black, GT Cord # C21421, Pin Out: Pin 2,4: +V, Pin 1,3, Shell: -V, Blades/Input Cord: (Order Separately), Approvals: cETLus; CB 60601-1-11; CB 60601-1; cETLus; S-Mark IEC/EN 60601-1; EAC; Korea (12-13.5V Only); CB 60950; CB 60335; cETLus 60601-1 3rd; Korea (18V Only); UKCA; Conforms to 62368-1; CCC; CB 62368; S-Mark 60950; ETL 62368; FCC; CAN ICES-3; Morocco; RCM; Korea(24-30V Only); IRAM; NOM (12V only); FCC; GEMS (12V); HKSM; Saudi (pending); Taiwan BSMI (12,15,18,19,24,48 and 54V); CE; RoHS; China RoHS; Ukraine; WEEE; VCCI; Class I; Level VI; PSE; PSE; PSE;	
	Model No. GTM961600P16019-T3	
	Part No./Ordering No. TR9CZ8421YL4IMR6B	Rev B

INSTRUCTIONS TO THE OEM SYSTEMS ENGINEER

It is the responsibility of the OEM systems engineer to provide the end system user instructions and warnings for the use of this product in the end system.

If an input cord is required for this product, AC Mains voltage should be provided to the power supply by a power supply cord approved to the national standards of the country in which it will be used.

This product is not designed to be repaired. No serviceable parts inside. A blown internal fuse is an indication of catastrophic failure of circuit component(s). If a Failure Analysis is required for a failed power supply/battery charger, please return the damaged unit to GlobTek for an accurate determination of the root cause of the failure.

EMC Compliance of the complete OEM product, including the GlobTek power supply/battery charger needs to be verified by the OEM systems engineer.

INSTRUCTION SHEET

N/A