



---

|                        |   |
|------------------------|---|
| <b>Title</b>           | <b><i>Reference Design Report for a High Performance 347 W PFC Stage Using HiperPFS™ PFS714EG</i></b> |
| <b>Specification</b>   | 90 VAC – 264 VAC Input; 380 VDC Output  |
| <b>Application</b>     | PFC Front End Stage   |
| <b>Author</b>          | Applications Engineering Department   |
| <b>Document Number</b> | RDR-236   |
| <b>Date</b>            | November 18, 2010   |
| <b>Revision</b>        | 1.1   |

### **Summary and Features**

- Low component count, high performance PFC
- EN61000–3–2 Class–D compliance
- High PFC efficiency enables 80+ PC Main design
- Frequency sliding maintains high efficiency across load range
- Feed forward line sense gain - maintains relatively constant loop gain over entire operating voltage range
- Excellent transient load response
- Power Integration eSIP low-profile, thermal resistance package

### **PATENT INFORMATION**

The products and applications illustrated herein (including transformer construction and circuits external to the products) may be covered by one or more U.S. and foreign patents, or potentially by pending U.S. and foreign patent applications assigned to Power Integrations. A complete list of Power Integrations' patents may be found at [www.powerint.com](http://www.powerint.com). Power Integrations grants its customers a license under certain patent rights as set forth at <http://www.powerint.com/ip.htm>.

## Table of Contents

|         |   |    |
|---------|---|----|
| 1       | Introduction.....   | 4  |
| 2       | Power Supply Specification .....                                  | 5  |
| 3       | Schematic.....  | 6  |
| 4       | Circuit Description .....   | 7  |
| 4.1     | Input EMI Filter and Rectifier .....                              | 7  |
| 4.2     | PFS714EG Boost Converter .....                                    | 7  |
| 4.3     | Bias Supply Regulator .....                                       | 7  |
| 4.4     | Input Feed Forward Sense Circuit.....                             | 7  |
| 4.5     | Output Feedback.....  | 8  |
| 5       | PCB Layout .....  | 9  |
| 6       | Bill of Materials .....   | 10 |
| 7       | Inductor Specification .....                                      | 12 |
| 7.1     | Electrical Diagram .....  | 12 |
| 7.2     | Electrical Specifications.....                                    | 12 |
| 7.3     | Materials.....  | 12 |
| 7.4     | Inductor Winding Instruction .....                                | 13 |
| 8       | Performance Data .....  | 16 |
| 8.1     | Efficiency (RT1 and RT2 Shorted).....                             | 16 |
| 8.2     | Input Power Factor .....  | 17 |
| 8.3     | Regulation .....  | 18 |
| 8.3.1   | Load .....  | 18 |
| 8.3.2   | Line .....  | 19 |
| 8.4     | Input Current Harmonic Distortion (IEC 61000–3–2 Class–D) .....   | 20 |
| 8.4.1   | 50% Load at Output .....  | 20 |
| 8.4.2   | 100% Load at Output .....   | 21 |
| 9       | Thermal Performance.....  | 22 |
| 10      | Waveforms.....  | 24 |
| 10.1    | Input Current at 115 VAC and 60 Hz.....                           | 24 |
| 10.2    | Input Current at 230 VAC and 50 Hz.....                           | 24 |
| 10.3    | Start-up at 90 VAC and 60 Hz.....                                 | 25 |
| 10.4    | Start-up at 115 VAC and 60 Hz.....                                | 25 |
| 10.5    | Start-up at 230 VAC and 50 Hz.....                                | 26 |
| 10.6    | Start-up at 264 VAC and 50 Hz.....                                | 26 |
| 10.7    | Load Transient Response (90 VAC, 60 Hz) .....                     | 27 |
| 10.8    | Load Transient Response (115 VAC, 60 Hz) .....                    | 28 |
| 10.9    | Load Transient Response (230 VAC, 50 Hz) .....                    | 28 |
| 10.10   | Load Transient Response (264 VAC, 50 Hz).....                     | 29 |
| 10.11   | 1000 ms Line Dropout (115 VAC / 60 Hz and 230 VAC / 50 Hz).....   | 29 |
| 10.11.1 | 50% Load at Output.....   | 29 |
| 10.11.2 | Full Load at Output .....   | 30 |
| 10.12   | One Cycle Line Dropout (115 VAC / 60 Hz and 230 VAC / 50 Hz)..... | 30 |
| 10.12.1 | Full Load at Output .....   | 30 |
| 10.13   | Line Sag (115 VAC – 85 VAC – 115 VAC, 60 Hz).....                 | 31 |
| 10.14   | Line Surge (132 VAC – 147 VAC – 132 VAC, 60 Hz).....              | 31 |
| 10.15   | Line Sag (230 VAC – 170 VAC – 230 VAC, 50 Hz).....                | 32 |



|         |  |    |
|---------|--|----|
| 10.16   | Line Surge (264 VAC – 293 VAC – 264 VAC, 50 Hz) .....            | 32 |
| 10.17   | Brown-In and Brown-Out at 6 V / Minute Rate .....                | 33 |
| 10.18   | Drain Voltage and Current .....                                  | 34 |
| 10.18.1 | Dain Voltage and Current at 115 VAC Input and Full Load.....     | 34 |
| 10.18.2 | Drain Voltage and Current at 230 VAC Input and Full Load.....    | 35 |
| 10.19   | Output Ripple Measurements .....                                 | 36 |
| 10.19.1 | Ripple Measurement Technique .....                               | 36 |
| 10.19.2 | Measurement Results .....  | 37 |
| 11      | Gain-Phase Measurement Procedure and Results .....               | 39 |
| 12      | Line Surge Test.....   | 41 |
| 13      | EMI Scans.....   | 42 |
| 13.1    | EMI Test Set-up.....   | 42 |
| 13.2    | EMI Scans .....  | 43 |
| 14      | Appendix A – Efficiency with Other Diode and Core Materials..... | 45 |
| 15      | Appendix B – Test Set-up for Efficiency Measurement .....        | 50 |
| 16      | Appendix C – Inductor Current Measurement Set-up.....            | 52 |
| 17      | Revision History .....   | 55 |

**Important Note:**

Although this board is designed to satisfy safety isolation requirements, the engineering prototype has not been agency approved. Therefore, all testing should be performed using an isolation transformer to provide the AC input to the prototype board.



## 1 Introduction

This document is an engineering report describing a PFC power supply utilizing a HiperPFS PFS714EG integrated PFC controller. This power supply is intended as a general purpose evaluation platform that operates from universal input and provides a regulated 380 V DC output voltage and a continuous output power of 347 W.

This power supply can deliver the rated power at 110 VAC or higher at a room temperature of 25 °C. For operation at higher temperatures or lower input voltages, use of forced air cooling is recommended.

The document contains the power supply specification, schematic, bill of materials, inductor documentation, printed circuit layout, and performance data.

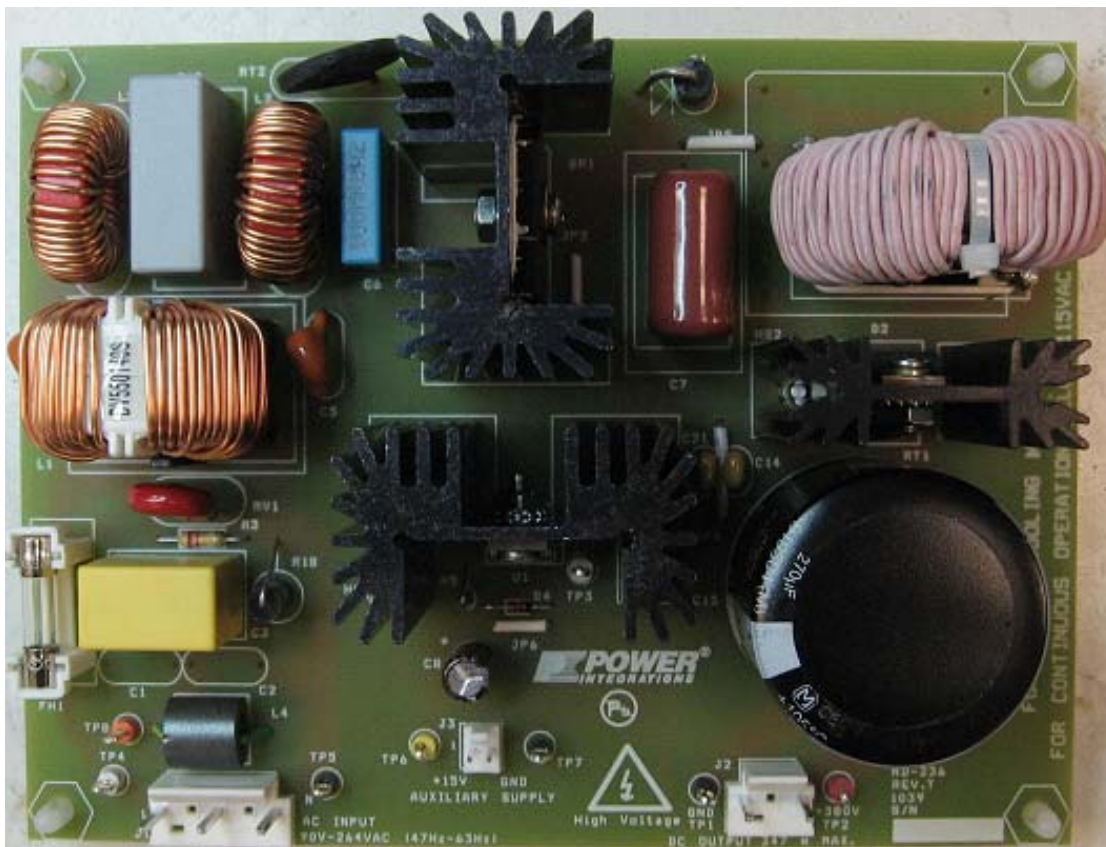


Figure 1 – Populated Circuit Board Photograph.



## 2 Power Supply Specification

The table below represents the minimum acceptable performance of the design. Actual performance is listed in the results section.

| Description   | Symbol       | Min | Typ   | Max | Units | Comment   |
|---|--------------|-----|-------|-----|-------|---|
| <b>Input</b>  |              |     |       |     |       |   |
| Voltage   | $V_{IN}$     | 90  |       | 264 | VAC   | 3 Wire  |
| Frequency   | $f_{LINE}$   | 47  | 50/60 | 64  | Hz    |   |
| <b>Output</b>                                       |              |     |       |     |       |   |
| Output Voltage                                      | $V_{OUT}$    | 370 | 380   | 390 | V     | 20 MHz bandwidth  |
| Output Ripple Voltage p-p                           | $V_{RIPPLE}$ |     |       | 30  | V     |   |
| Output Current                                      | $I_{OUT}$    |     | 0.913 |     | A     |   |
| <b>Total Output Power</b>                           |              |     |       |     |       |   |
| Continuous Output Power                             | $P_{OUT}$    |     | 347   |     | W     |   |
| <b>Efficiency</b>                                   |              |     |       |     |       |   |
| Full Load   | $\eta$       | 94  |       |     | %     | Measured at $P_{OUT}$ 25 °C   |
| Minimum efficiency at 20, 50 and 100 % of $P_{OUT}$ | $\eta_{80+}$ | 94  |       |     | %     | Measured at 115 VAC Input   |
| <b>Environmental</b>                                |              |     |       |     |       |   |
| Line Surge  |              |     |       |     |       | 1.2/50 $\mu$ s surge, IEC 1000-4-5,<br>Series Impedance:<br>Differential Mode: 2 $\Omega$<br>Common Mode: 12 $\Omega$ |
| Differential Mode (L1-L2)                           |              |     | 1     |     | kV    |   |
| Common mode (L1/L2-PE)                              |              |     | 2     |     | kV    |   |
| Ambient Temperature                                 | $T_{AMB}$    | 0   |       | 50  | °C    | Forced convection required at $T_{AMB}$<br>>25 °C and/or $V_{IN}$ <115 V, sea level                                   |
| <b>Auxiliary Supply Input</b>                       |              |     |       |     |       |   |
| Auxiliary Supply                                    | $V_{AUX}$    | 15  |       | 24  | V     | DC Supply   |



### 3 Schematic

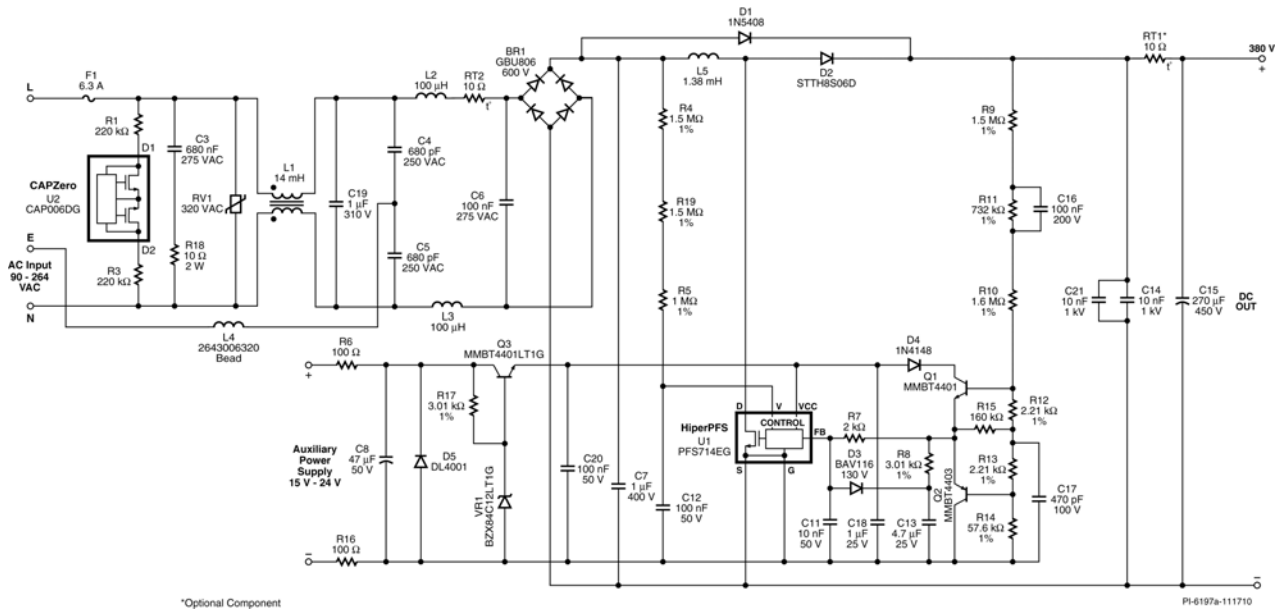


Figure 2 – Schematic.

## 4 Circuit Description

This PFC is designed using PFS714EG Power Integrations Integrated PFC controller. This design is rated for a continuous output power of 347 W and provides a regulated output voltage of 380 VDC nominal maintaining a high input power factor and overall efficiency from light load to full load.

### 4.1 Input EMI Filter and Rectifier

Fuse F1 provides protection to the circuit and isolates it from the AC supply in case of a fault. Diode Bridge BR1 rectifies the AC input. Capacitors C3, C4, C5, C6 and C19 together with inductors L1, L2 and L3 form the EMI filter reducing the common mode and differential mode noise. Resistors R1, R3 and CAPZero, IC U2 are required to discharge the EMI filter capacitors once the AC is disconnected. The use of CAPZero eliminates the static loss of R1 and R3, reducing standby and no-load input.

### 4.2 PFS714EG Boost Converter

The boost converter stage consists of inductor L5, diode rectifier D2, C15 and the PFS714EG IC U1. This converter stage controls the input current of the power supply while simultaneously regulating the output DC voltage. Diode D1 prevents a resonant build up of output voltage at start-up by bypassing inductor L5 while simultaneously charging output capacitor C15. Thermistors RT1 and RT2 limit the inrush current of the circuit at start-up, but they are not required simultaneously. In most high-performance designs, thermistor RT2 will often be used, in which case typically a relay will be used to bypass the thermistor after start-up to improve power supply efficiency. When thermistor RT2 is used, thermistor RT1 is replaced with a short. When thermistor RT1 is used, thermistor RT2 will be replaced with a short. When used, RT1 is in circuit at all times and results in slightly lower efficiency however saves the cost of the relay. Both locations of the thermistors are provided in the design to enable circuit configuration to suit the application. For efficiency measurement that represents the high performance configuration, both thermistors should be shorted. Capacitors C14 and C21 are used for reducing the loop length and area of the output circuit to reduce EMI and overshoot of voltage across the drain and source of the MOSFET inside U1 at each switching instant.

### 4.3 Bias Supply Regulator

The PFS714EG IC requires a regulated supply of 12 V for operation and must remain <13.4 V to avoid IC damage. Resistors R6, R16, R17, Zener diode VR1, and transistor Q3 form a shunt regulator that prevents the supply voltage to IC U1 from exceeding 12 V. Capacitors C8, C18 and C20 filter the supply voltage to ensure reliable operation of IC U1.

### 4.4 Input Feed Forward Sense Circuit

The input voltage of the power supply is sensed by the IC U1 using resistors R4, R5 and R19. The capacitor C12 filters any noise on this signal.



#### **4.5 Output Feedback**

Divider network comprising of resistors R9, R10, R11, R12, R13 and R14 are used to scale the output voltage and provide feedback to the IC U1. The circuit comprising of diode D4, transistor Q1, Q2 and the resistors R12 and R13 form a non-linear feedback circuit which help in improving the transient response by increasing the response time of the PFC circuit to large output voltage changes..

Resistors R7, R8, R15 and capacitors C13 and C17 are required for shaping the loop response of the feedback circuit. The combination of resistor R8 and capacitor C13 provide a low frequency zero.





### 5 PCB Layout

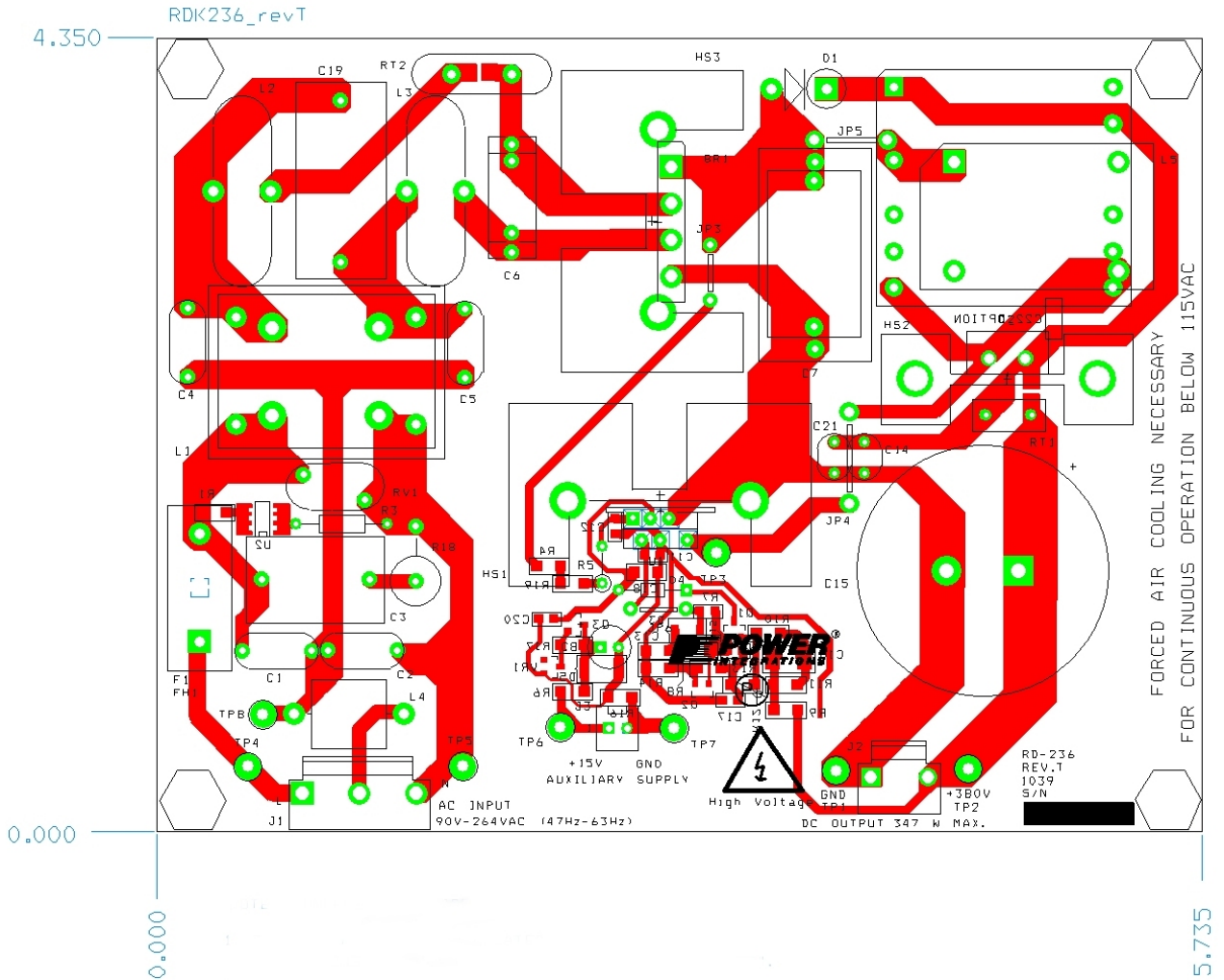


Figure 3 – Printed Circuit Layout.



## 6 Bill of Materials

| Item | Qty | Ref Des                      | Description   | Mfg Part Number     | Mfg                |
|------|-----|------------------------------|---|---------------------|--------------------|
| 1    | 1   | BR1                          | 600 V, 8 A, Bridge Rectifier  | GBU806              | Vishay             |
| 2    | 1   | C3                           | 680 nF, 275 VAC, Film,MPX Series, X2  | PX684K3ID6          | Carli              |
| 3    | 2   | C4 C5                        | 680 pF, Ceramic, Y1   | 440LT68-R           | Vishay             |
| 4    | 1   | C6                           | 100 nF, 275 VAC, Film, X2   | PHE840MB6100KB05R17 | Kemet              |
| 5    | 1   | C7                           | 1 $\mu$ F, 400 V, Polypropylene Film  | ECW-F4105JL         | Panasonic-ECG      |
| 6    | 1   | C8                           | 47 $\mu$ F, 50 V, Electrolytic, Gen. Purpose, (6.3 x 11)  | EKMG500ELL470MF11D  | Nippon Chemi-Con   |
| 7    | 1   | C11                          | 10 nF, 50 V, Ceramic, X7R, 0805   | ECJ-2VB1H103K       | Panasonic          |
| 8    | 2   | C12 C20                      | 100 nF, 50 V, Ceramic, X7R, 0805  | C2012X7R1H104K      | TDK                |
| 9    | 1   | C13                          | 4.7 $\mu$ F, 25 V, Ceramic, X7R, 1206   | ECJ-3YB1E475M       | Panasonic          |
| 10   | 2   | C14 C21                      | 10 nF, 1 kV, Disc Ceramic, X7R  | SV01AC103KAR        | AVX                |
| 11   | 1   | C15                          | 270 $\mu$ F, 450 V, Electrolytic (35 x 35)  | EET-ED2W271EA       | Panasonic          |
| 12   | 1   | C16                          | 100 nF, 200 V, Ceramic, X7R, 1812   | 18122C104KAT2A      | AVX                |
| 13   | 1   | C17                          | 470 pF, 100 V, Ceramic, X7R, 0805   | ECJ-2VB2A471K       | Panasonic          |
| 14   | 1   | C18                          | 1 $\mu$ F, 25 V, Ceramic, X7R, 1206   | C3216X7R1E105K      | TDK                |
| 15   | 1   | C19                          | 1 $\mu$ F, 310 VAC, Polyester Film, X2  | BFC233820105        | BC components      |
| 16   | 1   | D1                           | 1000 V, 3 A, Rectifier, DO-201AD  | 1N5408-T            | Diodes Inc.        |
| 17   | 1   | D2                           | 600 V, 8 A, Ultrafast Recovery, 12 ns, TO-220AC   | STTH8S06D           | ST Semiconductor   |
| 18   | 1   | D3                           | 130 V, 5%, 250 mW, SOD-123  | BAV116W-7-F         | Diodes Inc         |
| 19   | 1   | D4                           | 75 V, 300 mA, Fast Switching, DO-35   | 1N4148TR            | Vishay             |
| 20   | 1   | D5                           | 50 V, 1 A, Rectifier, Glass Passivated, DO-213AA (MELF)   | DL4001-13-F         | Diodes Inc         |
| 21   | 1   | ESIPCLIP<br>M4<br>METAL1     | Heatsink Hardware, Edge Clip, 20.76 mm L x 8 mm W x 0.015 mm Thk  | NP975864            | Aavid Thermalloy   |
| 22   | 1   | F1                           | 6.3 A, 250 V, Fast, 5 mm x 20 mm, Cartridge   | 021706.3HXP         | Littelfuse         |
| 23   | 1   | FH1                          | FUSEHOLDER OPEN 5 MM X 20 MM PC MNT   | 64900001039         | Wickmann USA       |
| 24   | 2   | HS1 HS3                      | HEATSINK, Alum, TO-220, TO218, 4.4 Deg C per Watt, Screw Type mounting with pins, L 1.00" (25.4mm), W 1.65" (41.91 mm) H 1.500" (38.1 mm) | 6398BG              | Aavid Thermalloy   |
| 25   | 1   | HS2                          | HEATSINK, Alum, TO-220, 11 Deg C per Watt, Screw Type mounting with pins, L 1.375" (34.92 mm), W 0.5" (12.7 mm) H 1.5" (38.1 mm)          | 513102B02500G       | Aavid Thermalloy   |
| 26   | 1   | HSPREAD<br>ER_ESIPP<br>FISW1 | HEATSPREADER, Custom, Al, 3003, 0.030" Thk  | 61-00040-00         | Custom             |
| 27   | 1   | J1                           | 5 Position (1 x 5) header, 0.156 pitch, Vertical  | 26-64-4050          | Molex              |
| 28   | 1   | J2                           | CONN HEADER 3POS (1x3).156 VERT TIN   | 26-64-4030          | Molex              |
| 29   | 1   | J3                           | 2 Position (1 x 2) header, 0.1 pitch, Vertical  | 22-23-2021          | Molex              |
| 30   | 2   | JP3 JP6                      | Wire Jumper, Insulated, 22 AWG, 0.3 in  | C2004-12-02         | Gen Cable          |
| 31   | 2   | JP4 JP5                      | Wire Jumper, Insulated, 18 AWG, 0.4 in  | C2052A-12-02        | Gen Cable          |
| 32   | 1   | L1                           | 14 mH, 5 A, Common Mode Choke   | DV550140S           | TNC                |
| 33   | 2   | L2 L3                        | 100 $\mu$ H, 5A, INDUCTOR TORD HI AMP 100UH VERT  | 7447070             | Würth Elect        |
| 34   | 1   | L4                           | 43 Shield Bead, 0.375 (9.5 mm) Dia x 0.410 (10.40 mm) L x 0.193 (4.75 mm) I.D. with PCBFP 22 AWG  | 2643006302          | Fair-Rite Products |



|    |   |  |  |                   |                         |
|----|---|--|--|-------------------|-------------------------|
| 35 | 1 | L5                                       | Custom, 350 W PFC Inductor, 1.38 mH, constructed on Lodestone Pacific base PN VTM160-4 | SNX-R1540         | Santronics              |
| 36 | 1 | LABEL1                                   | High Voltage (small)   |                   |                         |
| 37 | 1 | LABEL2                                   | High Voltage (large)   |                   |                         |
| 38 | 1 | NUT1                                     | Nut, Hex 4-40, SS  |                   |                         |
| 39 | 2 | NUT2<br>NUT3                             | Nut, Hex, Kep 4-40, S ZN Cr3 plating RoHS  | 4CKNTZR           | Any RoHS Compliant Mfg. |
| 40 | 4 | POST<br>PCB 6-32<br>HEX1-4               | Post, Circuit Board, Female, Hex, 6-32, snap, 0.375L, Nylon                            | 561-0375A         | Eagle Hardware          |
| 41 | 2 | Q1 Q3                                    | NPN, Small Signal BJT, GP SS, 40 V, 0.6 A, SOT-23                                      | MMBT4401LT1G      | OnSemi                  |
| 42 | 1 | Q2                                       | PNP, Small Signal BJT, 40 V, 0.6 A, SOT-23   | MMBT4403-7-F      | Diodes, Inc.            |
| 43 | 1 | R1                                       | 220 k $\Omega$ , 5%, 1/4 W, Thick Film, 1206   | ERJ-8GEYJ224V     | Panasonic               |
| 44 | 1 | R3                                       | 220 k $\Omega$ , 5%, 1/4 W, Carbon Film  | CFR-25JB-220K     | Yageo                   |
| 45 | 3 | R4 R9 R19                                | 1.50 M $\Omega$ , 1%, 1/4 W, Thick Film, 1206  | ERJ-8ENF1504V     | Panasonic               |
| 46 | 1 | R5                                       | 1 M $\Omega$ , 1%, 1/4 W, Metal Film   | MFR-25FBF-1M00    | Yageo                   |
| 47 | 2 | R6 R16                                   | 100 $\Omega$ , 1%, 1/4 W, Thick Film, 1206   | ERJ-8ENF1000V     | Panasonic               |
| 48 | 1 | R7                                       | 2 k $\Omega$ , 5%, 1/8 W, Thick Film, 0805   | ERJ-6GEYJ202V     | Panasonic               |
| 49 | 2 | R8 R17                                   | 3.01 k $\Omega$ , 1%, 1/4 W, Thick Film, 1206  | ERJ-8ENF3011V     | Panasonic               |
| 50 | 1 | R10                                      | 1.60 M $\Omega$ , 1%, 1/4 W, Thick Film, 1206  | ERJ-8ENF1604V     | Panasonic               |
| 51 | 1 | R11                                      | 732 k $\Omega$ , 1%, 1/4 W, Thick Film, 1206   | ERJ-8ENF7323V     | Panasonic               |
| 52 | 2 | R12 R13                                  | 2.21 k $\Omega$ , 1%, 1/4 W, Thick Film, 1206  | ERJ-8ENF2211V     | Panasonic               |
| 53 | 1 | R14                                      | 57.6 k $\Omega$ , 1%, 1/4 W, Thick Film, 1206  | ERJ-8ENF5762V     | Panasonic               |
| 54 | 1 | R15                                      | 160 k $\Omega$ , 5%, 1/8 W, Thick Film, 0805   | ERJ-6GEYJ164V     | Panasonic               |
| 55 | 1 | R18                                      | 10 $\Omega$ , 1%, 2 W, Wire Wound  | WHC10RFET         | Ohmite                  |
| 56 | 1 | RT1                                      | NTC Thermistor, 10 $\Omega$ , 3.2 A  | CL-110            | GE Sensing              |
| 57 | 1 | RT2                                      | NTC Thermistor, 10 $\Omega$ , 5 A  | CL-60             | GE Sensing              |
| 58 | 1 | RTV1                                     | Thermally conductive Silicone Grease   | 120-SA            | Wakefield               |
| 59 | 1 | RV1                                      | 320 V, 23 J, 10 mm, RADIAL   | V320LA10P         | Littlefuse              |
| 60 | 3 | SCREW1<br>SCREW2<br>SCREW3               | SCREW MACHINE PHIL 4-40 X 3/8 SS   | PMSSS 440 0038 PH | Building Fasteners      |
| 61 | 1 | TO-220<br>PAD1                           | HEATPAD TO-247 .006" K10   | K10-104           | Bergquist               |
| 62 | 3 | TP1 TP5<br>TP7                           | Test Point, BLK, THRU-HOLE MOUNT   | 5011              | Keystone                |
| 63 | 1 | TP2                                      | Test Point, RED, THRU-HOLE MOUNT   | 5010              | Keystone                |
| 64 | 2 | TP3 TP4                                  | Test Point, WHT, THRU-HOLE MOUNT   | 5012              | Keystone                |
| 65 | 1 | TP6                                      | Test Point, YEL, THRU-HOLE MOUNT   | 5014              | Keystone                |
| 66 | 1 | TP8                                      | Test Point, ORG, THRU-HOLE MOUNT   | 5013              | Keystone                |
| 67 | 1 | U1                                       | HiperPFS, PFS714EG, eSIP7/6-TH   | PFS714EG          | Power Integrations      |
| 68 | 1 | U2                                       | CAPZero, CAP006DG, SO-8C   | CAP006DG          | Power Integrations      |
| 69 | 1 | VR1                                      | 12 V, 5%, 225 mW, SOT23  | BZX84C12LT1G      | OnSemi                  |
| 70 | 4 | WASHER1<br>WASHER2<br>WASHER3<br>WASHER4 | WASHER FLAT #4 SS  | FWSS 004          | Building Fasteners      |
| 71 | 1 | WASHER5                                  | Washer, Lk, #4 SS  | 4NSLWS            | Olander                 |
| 72 | 1 | WASHER6                                  | Washer, Shoulder, #4, 0.095 Shoulder x 0.117 Dia, Polyphenylene Sulfide PPS            | 7721-10PPSG       | Aavid Thermalloy        |
| 73 | 1 | WASHER7                                  | Washer Teflon #6, ID 0.156, OD 0.312, Thk 0.031  | FWF-6             |                         |



## 7 Inductor Specification

### 7.1 Electrical Diagram

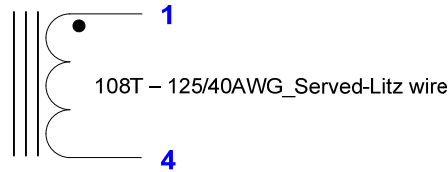


Figure 4 – Inductor Electrical Diagram.

### 7.2 Electrical Specifications

|                           |                                     |              |
|---------------------------|-------------------------------------|--------------|
| <b>Primary Inductance</b> | Pins 1–4 measured at kHz, 0.4 V RMS | 1.38 mH, ±8% |
|---------------------------|-------------------------------------|--------------|

### 7.3 Materials

| Item | Description   |
|------|---|
| [1]  | Core: Magnetics Inc, Mfg: 77324A7.  |
| [2]  | Magnet wire: 125/40 Served – Litz wire.   |
| [3]  | Base: Toroid mounting base, Lodestone Pacific, P/N VTM160–4, or similar. See below. PI P/N: 76–00004–00.            |
| [4]  | High Temperature Epoxy, Mfg: MG Chemicals, P/N: 832HT–375ML, Digikey: 473–1085–ND, or similar, PI P/N: 66–00087–00. |
| [5]  | Divider: Tie-wrap, Panduit, P/N: PLT.7M–M or similar.   |

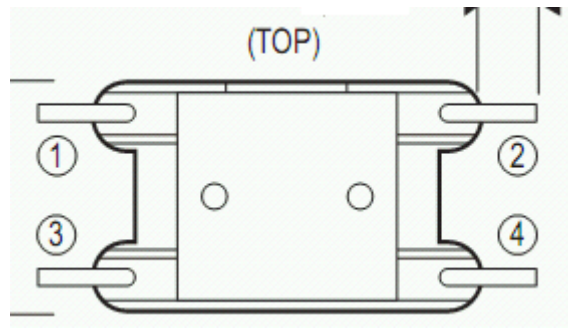
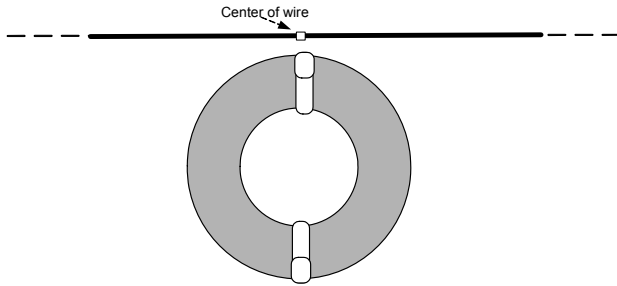


Figure 5 – Top View of Toroid Mounting Base Item [3]

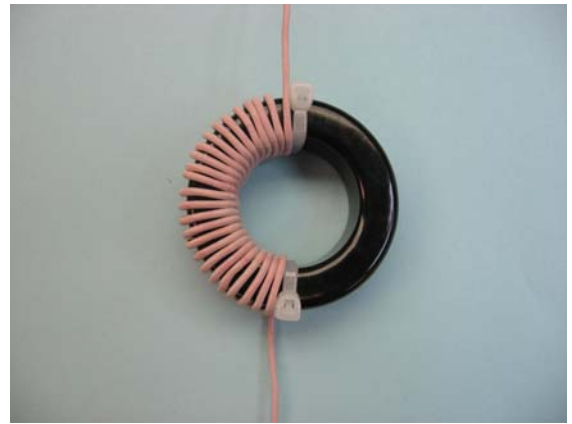
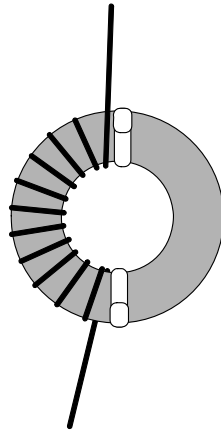


### 7.4 Inductor Winding Instruction

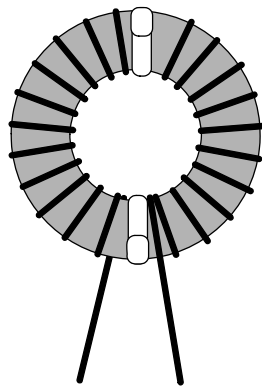
- Insert 2 dividers item [5] in the core item [1] to divide into 2 sections equally. See picture beside. Take about 15ft of wire item [2]. Align center of wire with 1 divider.



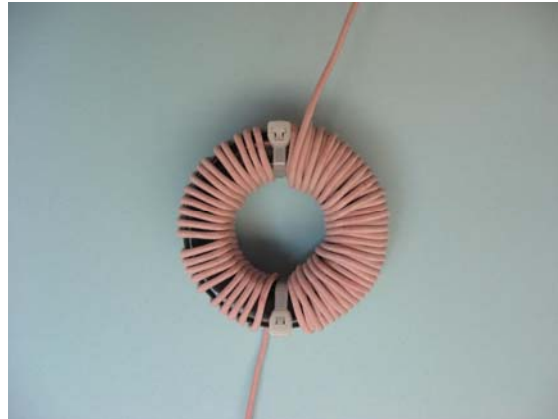
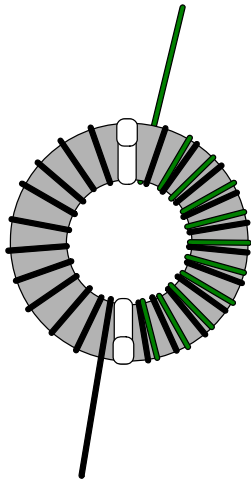
- Start winding on the left section with 23 turns of wire item [2], for the 1st layer, spread wire evenly and ensure that turns do not overlap.



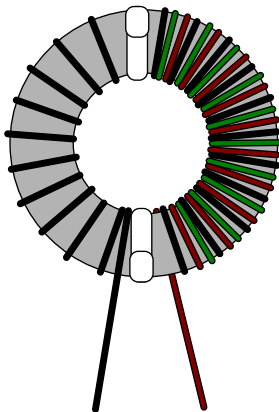
- Also wind another 23 turns on the right section.



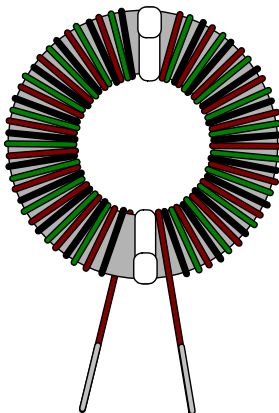
- Continue winding on the right section for the 2<sup>nd</sup> layer 18 turns, spread wire evenly and ensure that turns do not overlap.



- Continue winding on the right section on the 3<sup>rd</sup> layer 13 turns, scatter wire evenly and ensure that turns do not overlap.

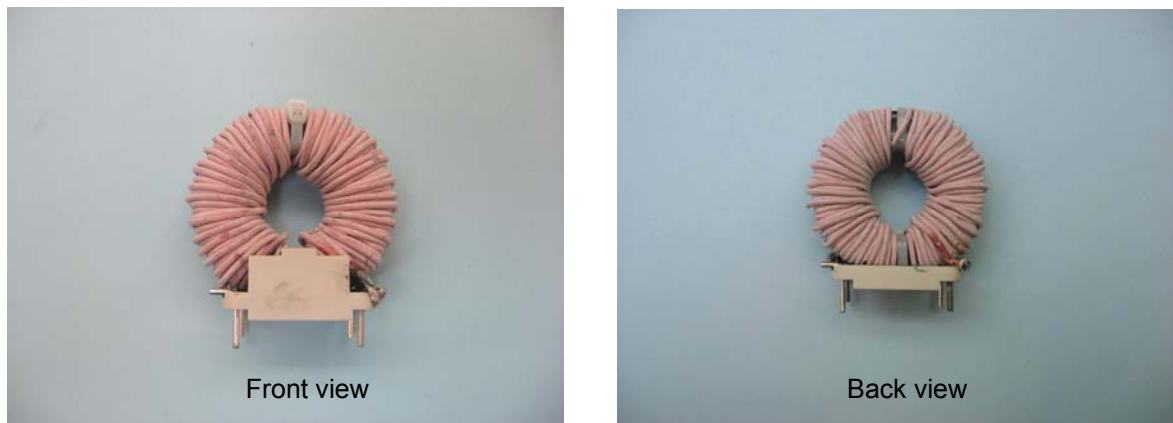


- Wind the same as above for the 2<sup>nd</sup> and 3<sup>rd</sup> layer on the left section.



- Secure the inductor with the base by using High Temperature Epoxy item [4].





- Solder the leads to the pin 1 and 4 of mounting base item [3].

**Figure 6** – Finished Inductor

## 8 Performance Data

All measurements performed at room temperature, 60 Hz input frequency for voltages below 150 VAC and input frequency of 50 Hz for 150 VAC and higher.

*All performance data except for data presented in the appendix is with Thermistors RT1 and RT2 shorted to represent the high performance configuration which uses RT2 to limit inrush current and shorts thermistor RT2 using a relay after start-up to improve operating efficiency.*

### 8.1 Efficiency (RT1 and RT2 Shorted)

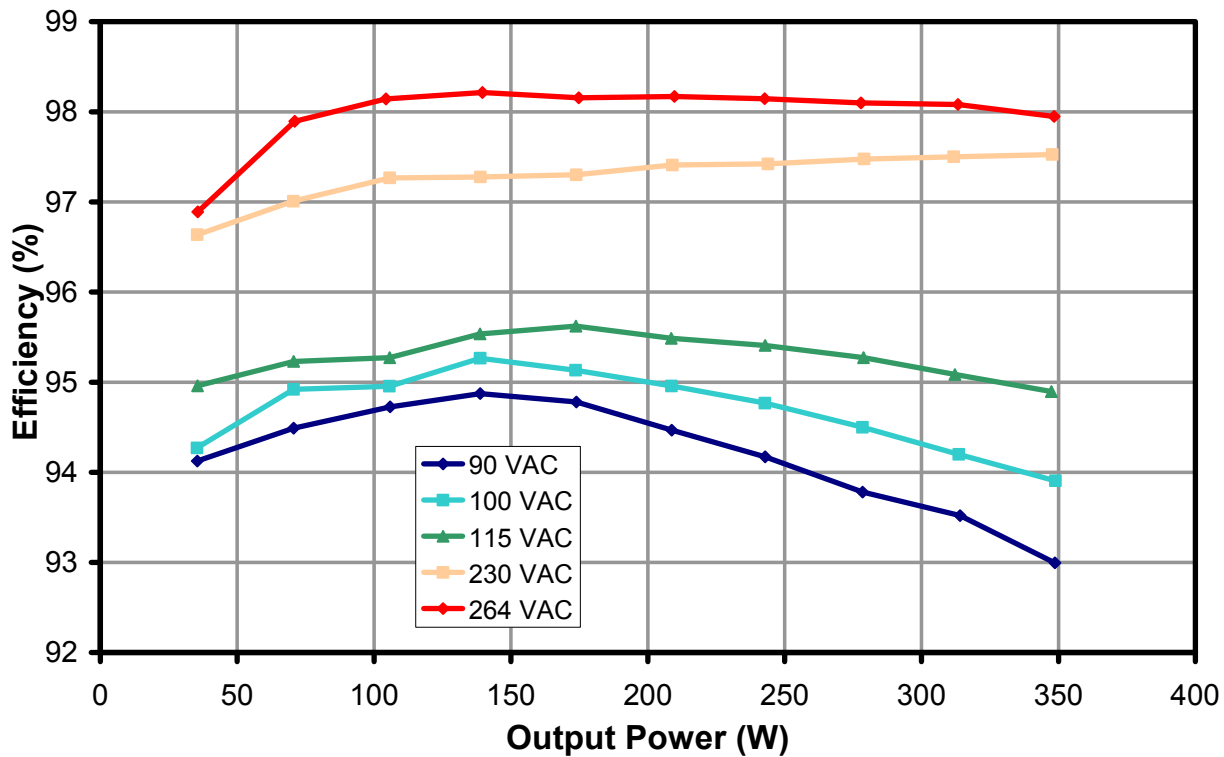


Figure 7 – Efficiency vs. Output Power.



### 8.2 Input Power Factor

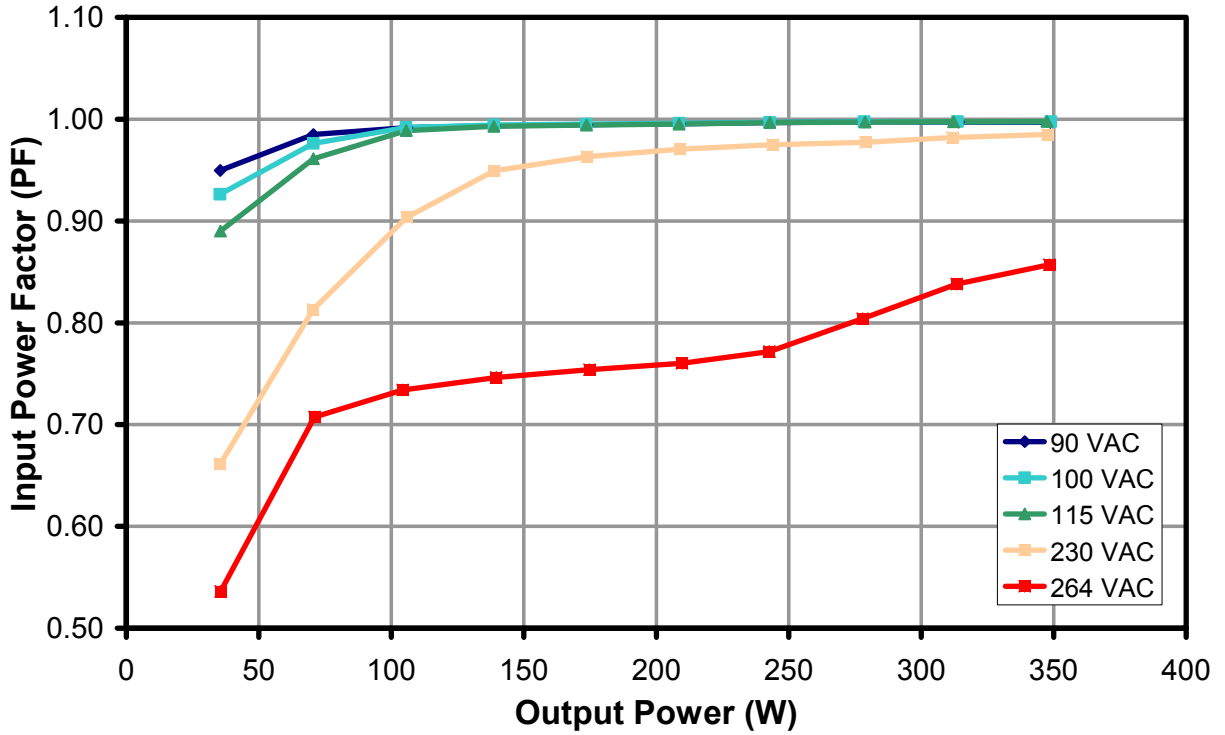


Figure 8 – Input Power Factor vs. Output Power.



### 8.3 Regulation

#### 8.3.1 Load

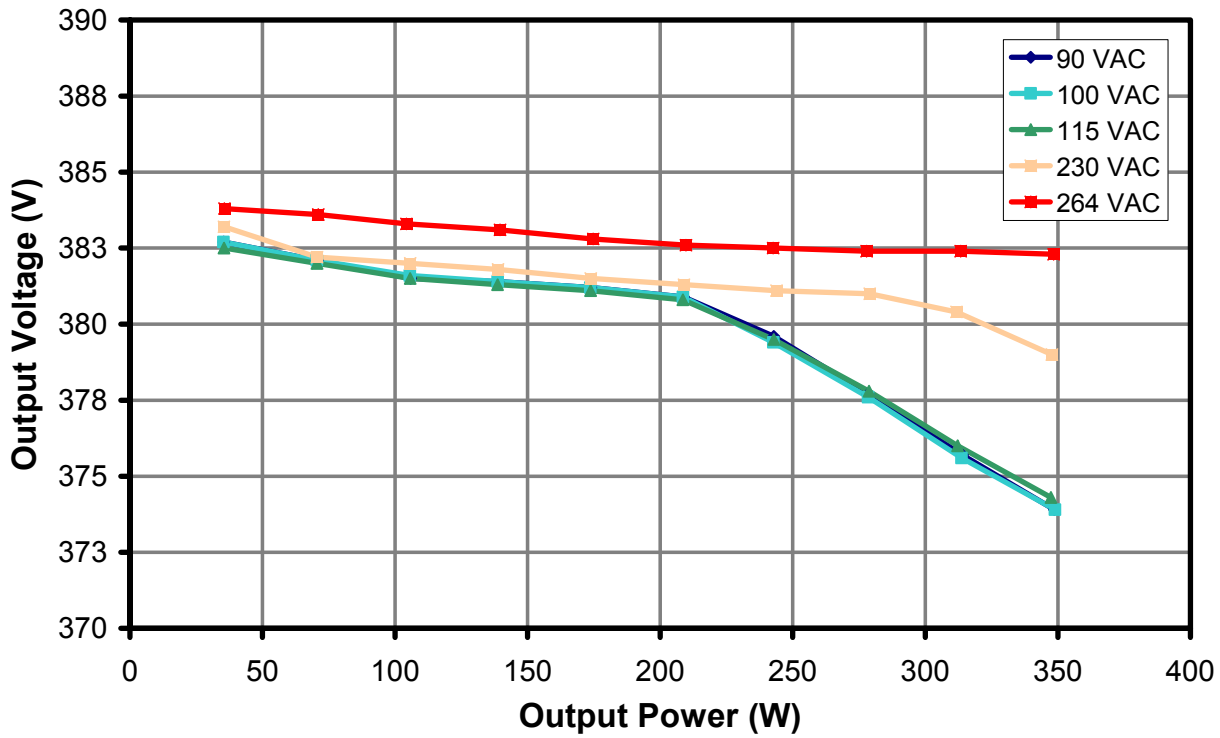


Figure 9 – Load Regulation.



8.3.2 Line

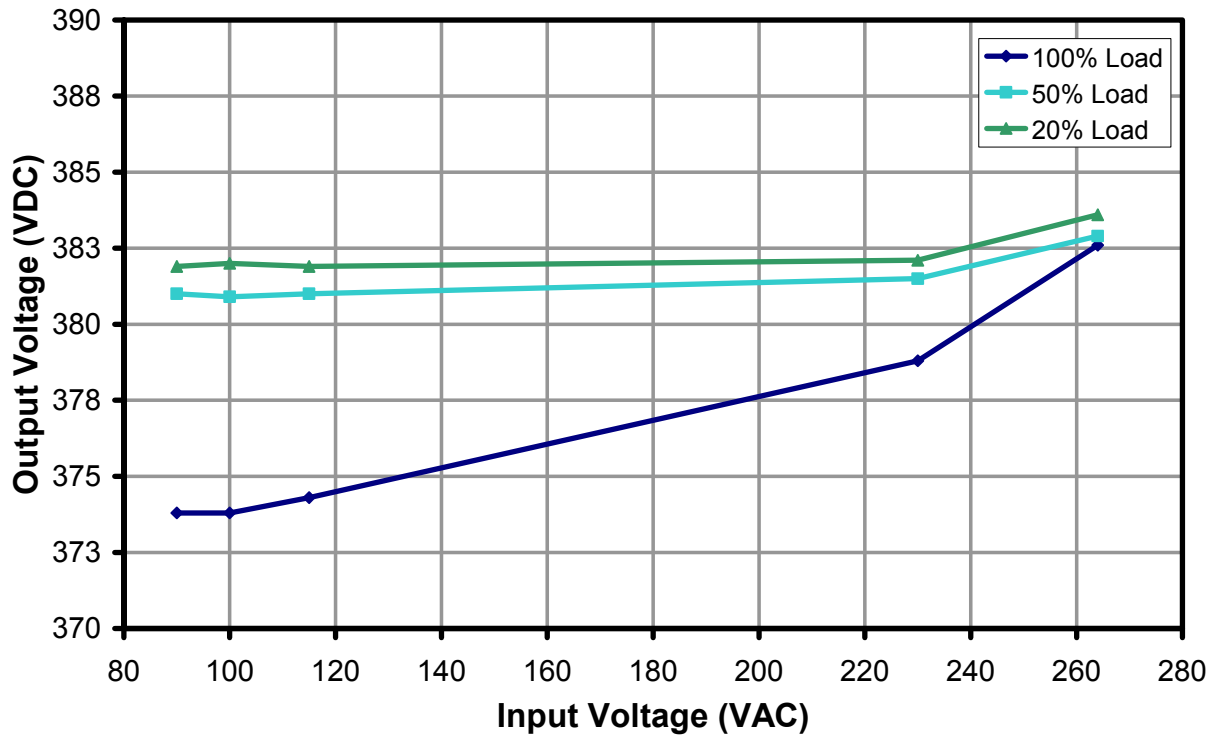


Figure 10 – Line Regulation.



### 8.4 Input Current Harmonic Distortion (IEC 61000-3-2 Class-D)

Measured at 230 VAC Input 50Hz

#### 8.4.1 50% Load at Output

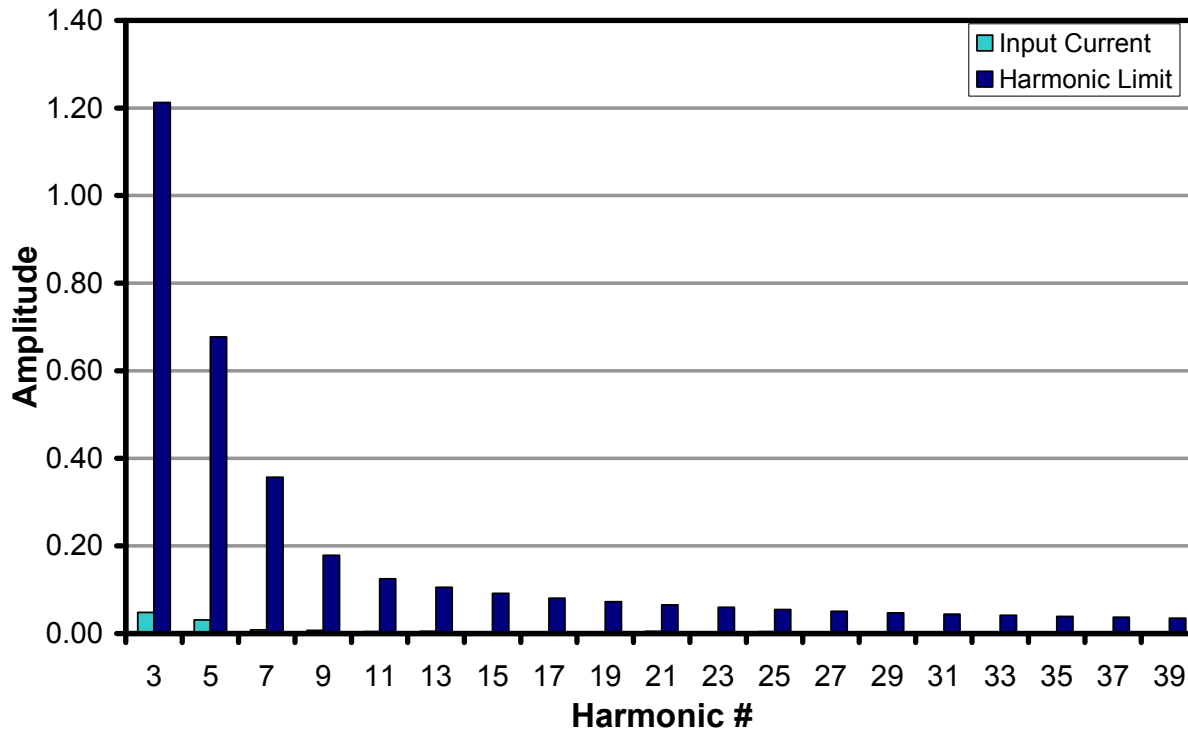


Figure 11 – Amplitude of Input Current Harmonics for 50% Load at 230 VAC Input.



8.4.2 100% Load at Output

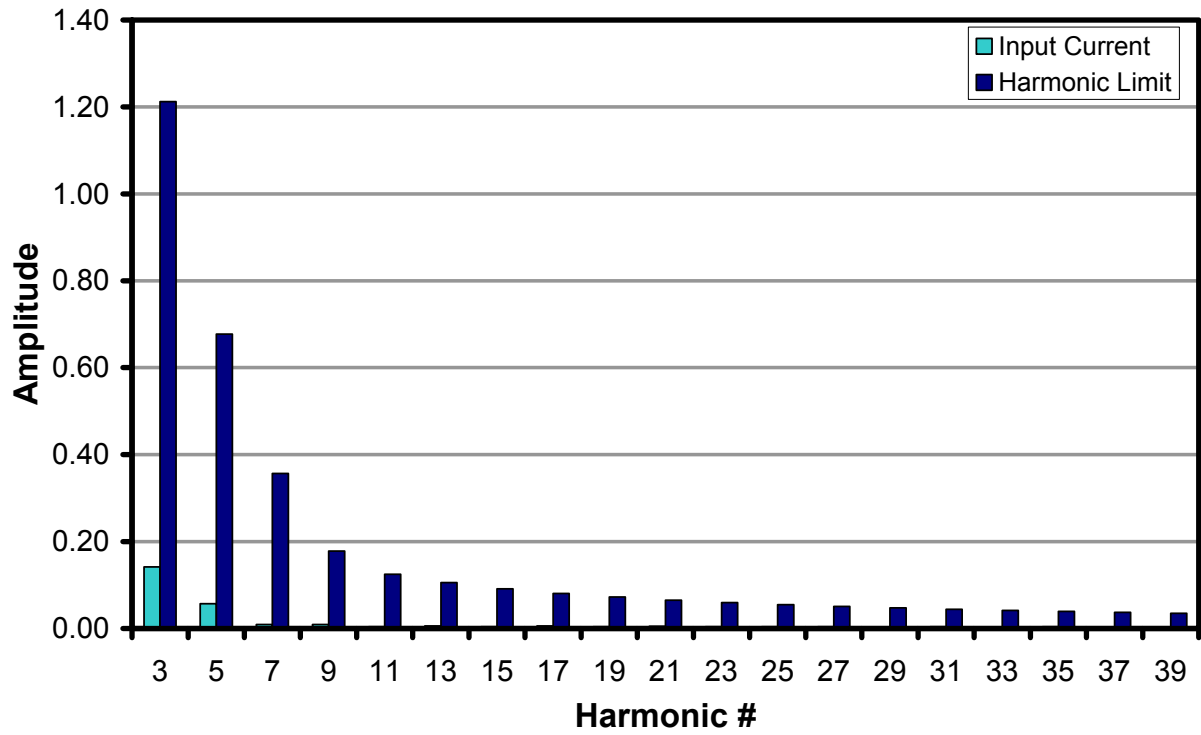


Figure 12 – Amplitude of Input Current Harmonics for 100% Load at 230 VAC Input.



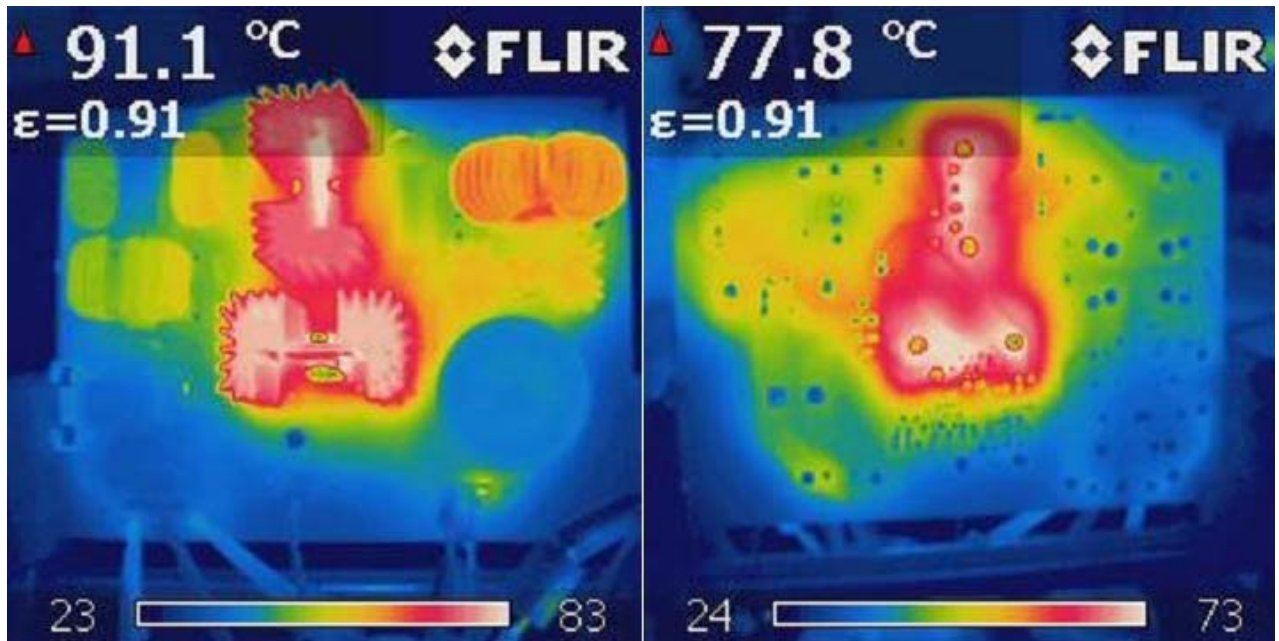
## 9 Thermal Performance

The unit was allowed to reach thermal equilibrium prior to the measurement. Table 1 shows full load temperature of key components at equilibrium, room temperature and without any forced air cooling.

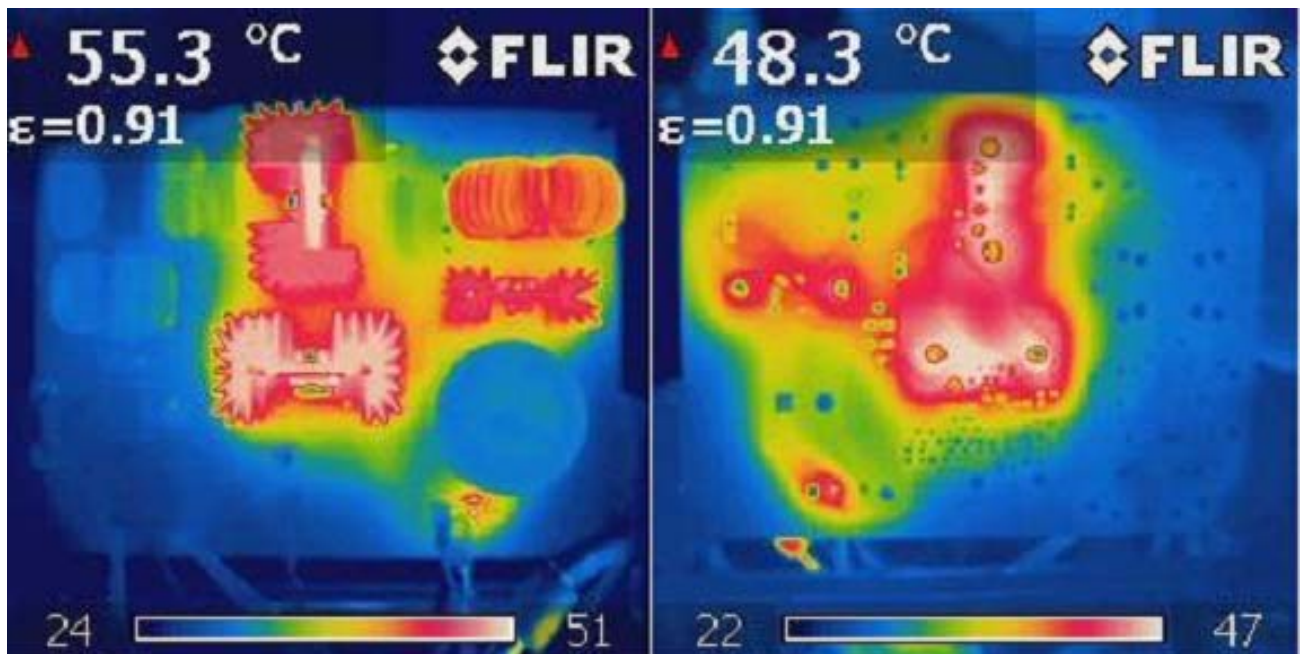
| Component            | Temperature (° C) |         |
|----------------------|-------------------|---------|
|                      | 240 VAC           | 115 VAC |
| C3                   | 28.1              | 29.9    |
| C6                   | 36.0              | 47.2    |
| C7                   | 41.1              | 53.2    |
| C15                  | 35.6              | 42.8    |
| C19                  | 36.2              | 40.3    |
| D2                   | 53.4              | 68.4    |
| L1                   | 33.0              | 47.5    |
| L2                   | 31.8              | 41.9    |
| L3                   | 36.8              | 54.9    |
| L5                   | 57.6              | 78.9    |
| BR1                  | 59.5              | 95.0    |
| Heatsink – BR1       | 51.8              | 76.3    |
| Heatsink – D2        | 51.6              | 62.8    |
| Heatsink – U1        | 50.8              | 78.1    |
| U1                   | 59.5              | 98.2    |
| Ambient Temperature: | 25.0              | 25.0    |

**Table 1** – Thermal Performance of Key Components at Full Load.





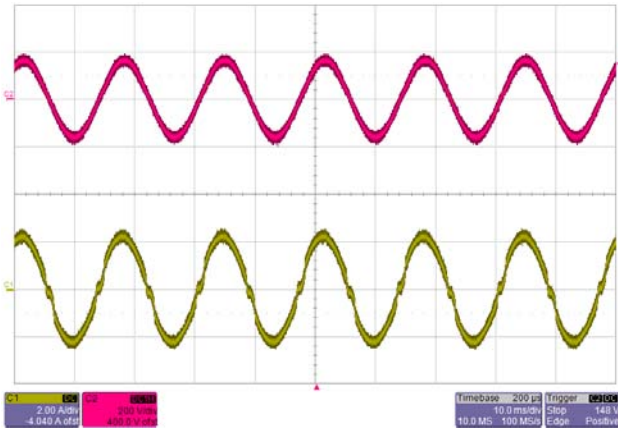
**Figure 13** – Infrared Image of the Top and Bottom Side of the Board at Thermal Equilibrium. 115 VAC, Full Load, No Forced-Air Flow, 25°C Ambient.



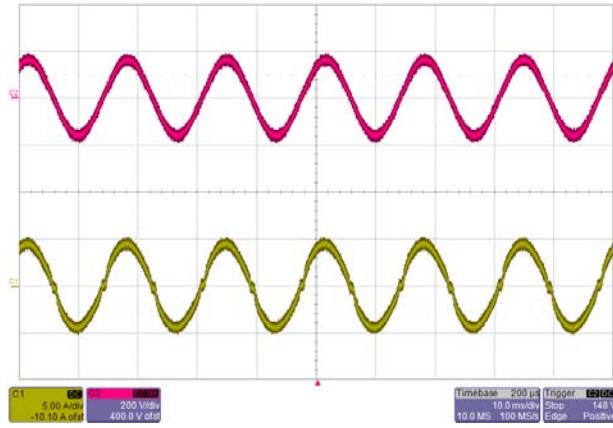
**Figure 14** – Infrared Image of the Top and Bottom Sides of the Board at Thermal Equilibrium. 230 VAC, Full Load, No Forced-Air Flow, 25°C Ambient.

## 10 Waveforms

### 10.1 Input Current at 115 VAC and 60 Hz

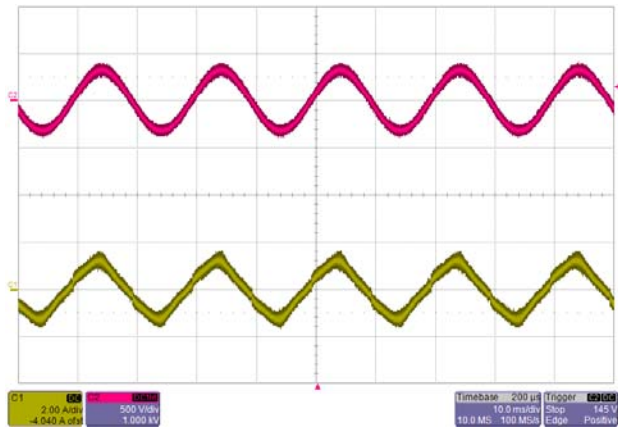


**Figure 15**– 115 VAC, 50% Load.  
 Top:  $V_{IN}$ , 200 V / div.  
 Bottom:  $I_{IN}$ , 2 A, 10 ms / div.

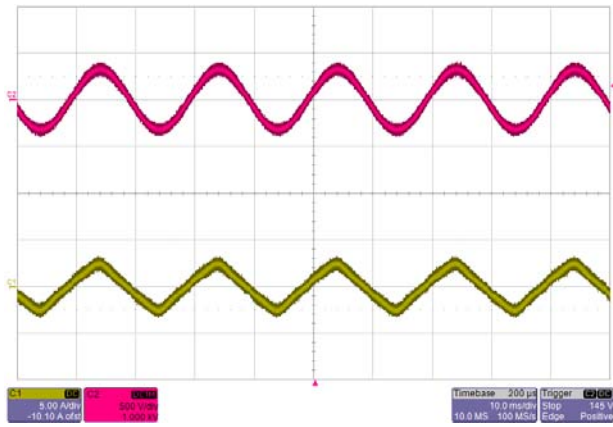


**Figure 16** – 115 VAC, 100% Load.  
 Top:  $V_{IN}$ , 200 V / div.  
 Bottom:  $I_{IN}$ , 5 A, 10 ms / div.

### 10.2 Input Current at 230 VAC and 50 Hz



**Figure 17** – 230 VAC, 50% Load.  
 Top:  $V_{IN}$ , 500 V / div.  
 Bottom:  $I_{IN}$ , 2 A, 10 ms / div.

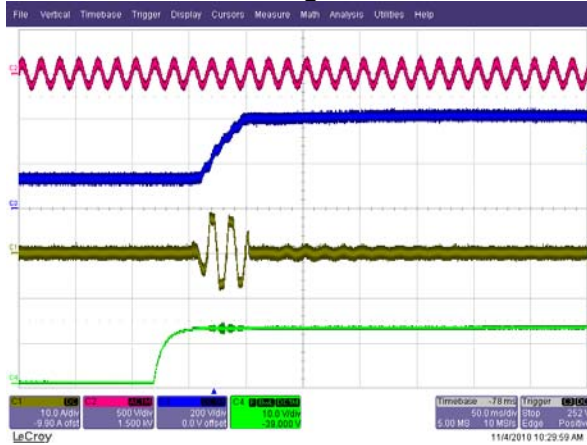


**Figure 18** – 230 VAC, 100% Load.  
 Top:  $V_{IN}$ , 500 V / div.  
 Bottom:  $I_{IN}$ , 5 A, 10 ms / div.

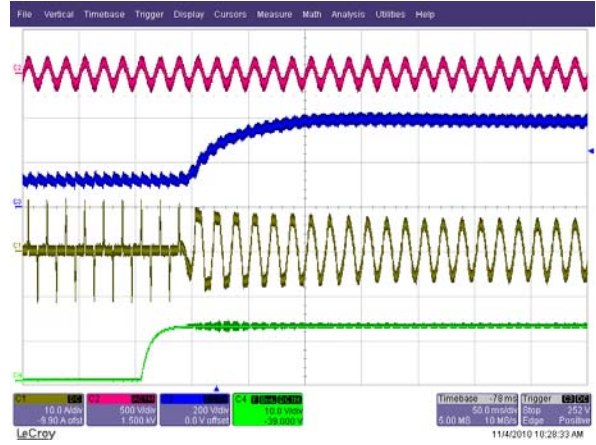


### 10.3 Start-up at 90 VAC and 60 Hz

Load in CC mode during turn-on of PFC



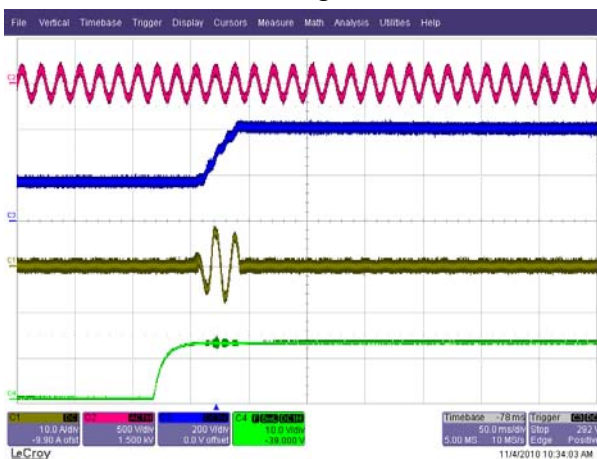
**Figure 19** – 90 VAC, No Load.  
 Top:  $V_{IN}$ , 500 V / div.  
 Second: Output Voltage, 200 V / div.  
 Third:  $I_{IN}$ , 10 A / div.  
 Bottom:  $V_{CC}$ , 10 V / div., 50 ms / div.



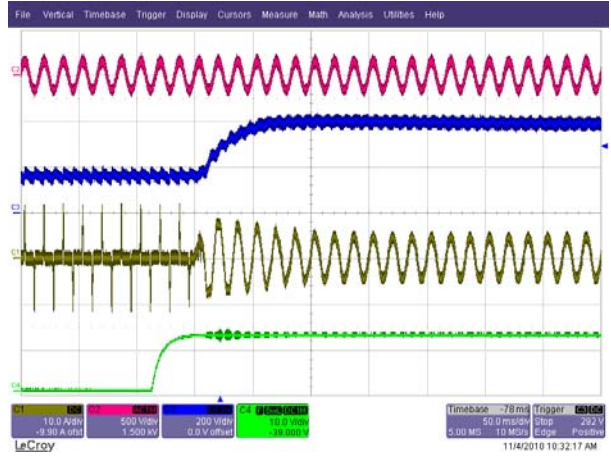
**Figure 20** – 90 VAC, Full Load.  
 Top:  $V_{IN}$ , 500 V / div.  
 Second: Output Voltage, 200 V / div.  
 Third:  $I_{IN}$ , 10 A / div.  
 Bottom:  $V_{CC}$ , 10 V / div., 50 ms / div.

### 10.4 Start-up at 115 VAC and 60 Hz

Load in CC mode during turn-on of PFC



**Figure 21** – 115 VAC, No Load.  
 Top:  $V_{IN}$ , 500 V / div.  
 Second: Output Voltage, 200 V / div.  
 Third:  $I_{IN}$ , 10 A / div.  
 Bottom:  $V_{CC}$ , 10 V / div., 50 ms / div.

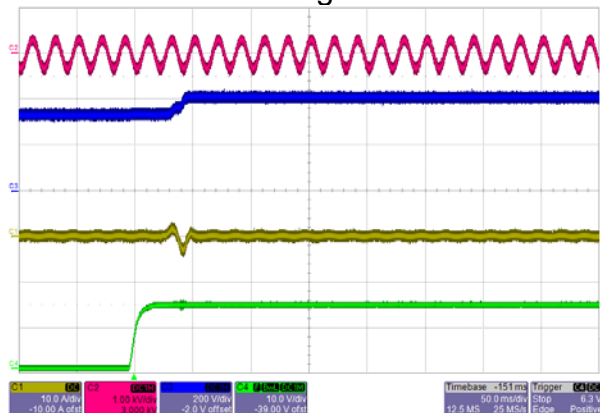


**Figure 22** – 115 VAC, Full Load.  
 Top:  $V_{IN}$ , 500 V / div.  
 Second: Output Voltage, 200 V / div.  
 Third:  $I_{IN}$ , 10 A / div.  
 Bottom:  $V_{CC}$ , 10 V / div., 50 ms / div.

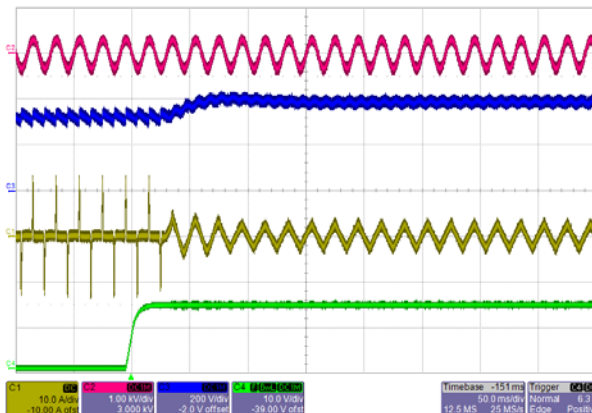


### 10.5 Start-up at 230 VAC and 50 Hz

Load in CC mode during turn-on of PFC



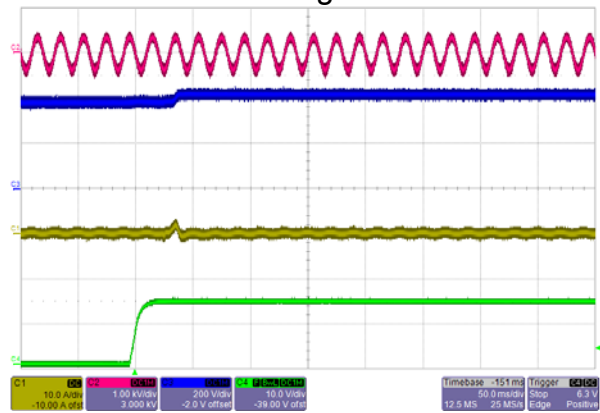
**Figure 23** – 230 VAC, No-load.  
 Top:  $V_{IN}$ , 1 kV / div.  
 Second: Output Voltage, 200 V / div.  
 Third:  $I_{IN}$ , 10 A / div.  
 Bottom:  $V_{CC}$ , 10 V, 50 ms / div.



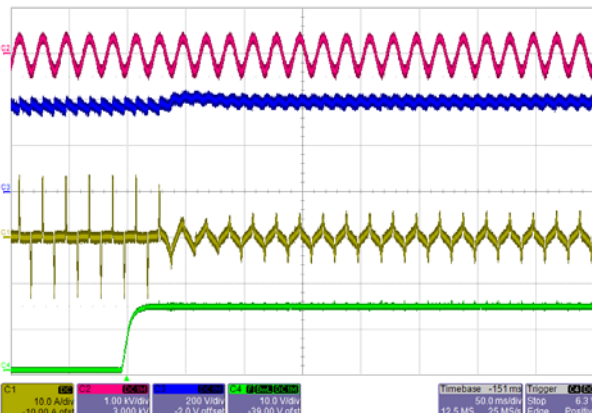
**Figure 24** – 230 VAC, Full Load.  
 Top:  $V_{IN}$ , 1 kV / div.  
 Second: Output Voltage, 200 V / div.  
 Third:  $I_{IN}$ , 10 A / div.  
 Bottom:  $V_{CC}$ , 10 V, 50 ms / div.

### 10.6 Start-up at 264 VAC and 50 Hz

Load in CC mode during turn-on of PFC



**Figure 25** – 264 VAC, No-load.  
 Top:  $V_{IN}$ , 1 kV / div.  
 Second: Output Voltage, 200 V / div.  
 Third:  $I_{IN}$ , 10 A / div.  
 Bottom:  $V_{CC}$ , 10 V, 50 ms / div.

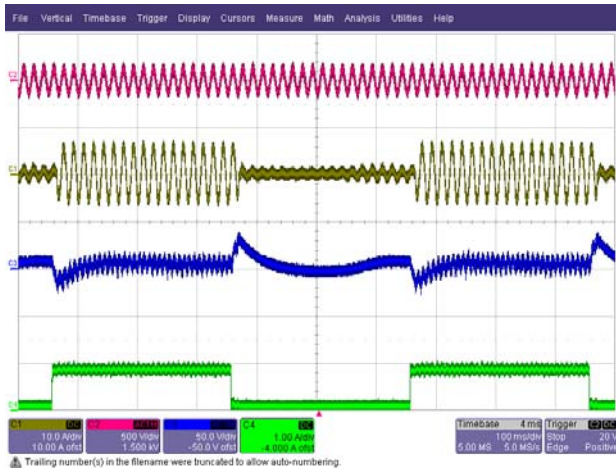


**Figure 26** – 264 VAC, Full Load.  
 Top:  $V_{IN}$ , 1 kV / div.  
 Second: Output Voltage, 200 V / div.  
 Third:  $I_{IN}$ , 10 A / div  
 Bottom:  $V_{CC}$ , 10 V, 50 ms / div.

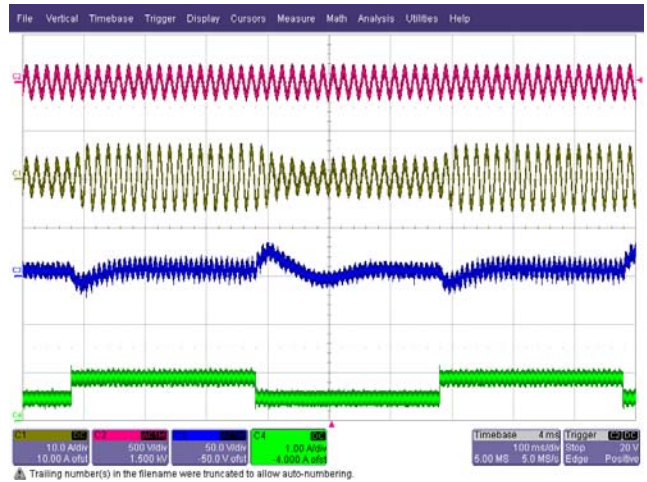


### 10.7 Load Transient Response (90 VAC, 60 Hz)

In the figures shown below, signal averaging was used to better enable viewing the load transient response. The oscilloscope was triggered using the load current step as a trigger source. Since the output switching and line frequency occur essentially at random with respect to the load transient, contributions to the output ripple from these sources will average out, leaving the contribution only from the load step response.



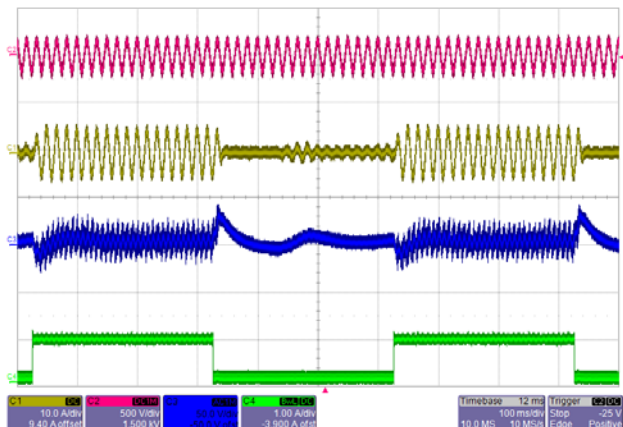
**Figure 27** – Transient Response, 90 VAC,  
10–100–10% Load Step.  
Top: Input Voltage, 500 V / div.  
Second: Input Current, 10 A /div.  
Third: Output Voltage (AC Coupled),  
50 V / div.  
Bottom: Load Current 1 A, 100 ms / div.



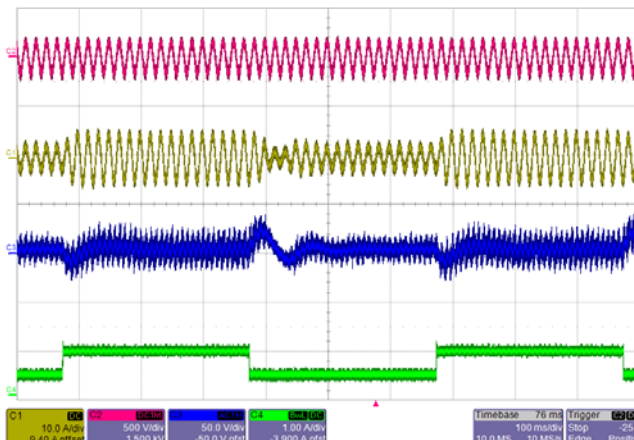
**Figure 28** – Transient Response, 90 VAC,  
50–100–50% Load Step  
Top: Input Voltage, 500 V / div.  
Second: Input Current, 10 A / div.  
Third: Output Voltage (AC Coupled),  
50 V / div.  
Bottom: Load Current 1 A, 100 ms / div.



### 10.8 Load Transient Response (115 VAC, 60 Hz)

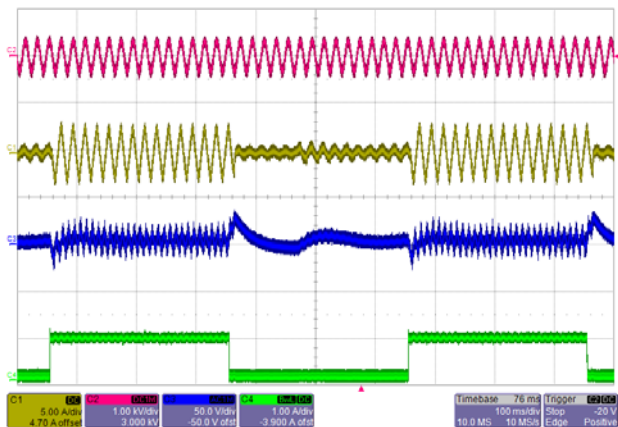


**Figure 29** – Transient Response, 115 VAC, 10–100–10% Load Step.  
 Top: Input Voltage, 500 V / div.  
 Second: Input Current, 10 A /div.  
 Third: Output Voltage (AC Coupled), 50 V / div.  
 Bottom: Load Current 1 A, 100 ms / div.

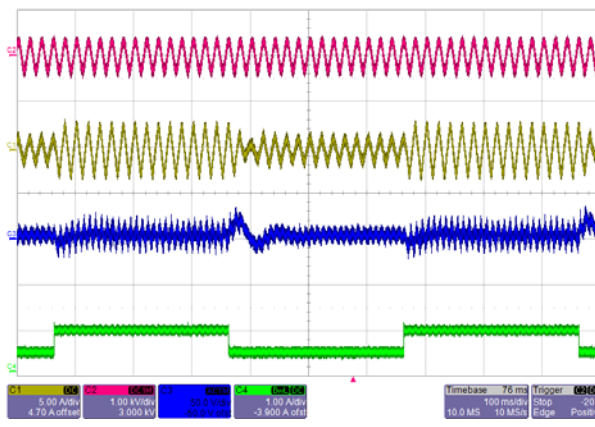


**Figure 30** – Transient Response, 115 VAC, 50–100–50% Load Step  
 Top: Input Voltage, 500 V / div.  
 Second: Input Current, 10 A /div.  
 Third: Output Voltage (AC Coupled), 50 V / div.  
 Bottom: Load Current 1 A, 100 ms / div.

### 10.9 Load Transient Response (230 VAC, 50 Hz)



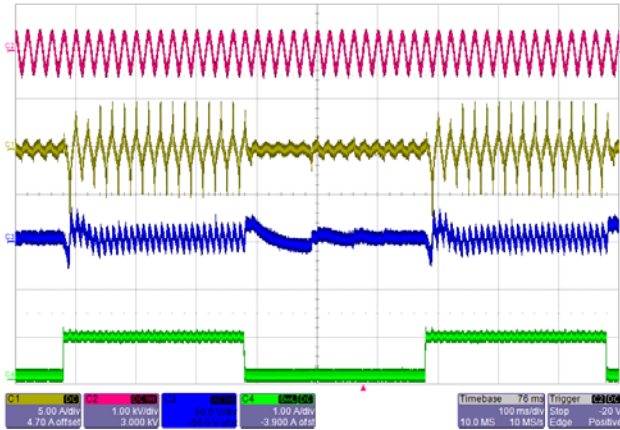
**Figure 31** – Transient Response, 230 VAC, 10–100–10% Load Step.  
 Top: Input Voltage, 1 KV / div.  
 Second: Input Current, 5 A / div.  
 Third: Output Voltage (AC Coupled), 50 V / div.  
 Bottom: Load Current 1 A, 100 ms / div.



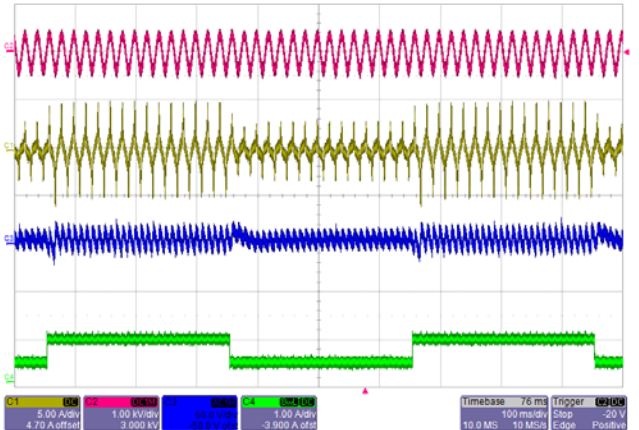
**Figure 32** – Transient Response, 230 VAC, 50–100–50% Load Step  
 Top: Input Voltage, 1 KV / div.  
 Second: Input Current, 5 A / div.  
 Third: Output Voltage (AC Coupled), 50 V / div.  
 Bottom: Load Current 1 A, 100 ms / div.



**10.10 Load Transient Response (264 VAC, 50 Hz)**



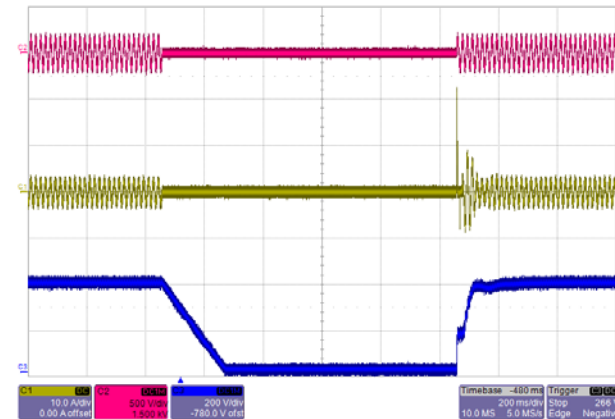
**Figure 33** – Transient Response, 264 VAC, 10–100–10% Load Step.  
 Top: Input Voltage, 1 KV / div.  
 Second: Input Current, 5 A / div.  
 Third: Output Voltage (AC Coupled), 50 V / div.  
 Bottom: Load Current 1 A, 100 ms / div.



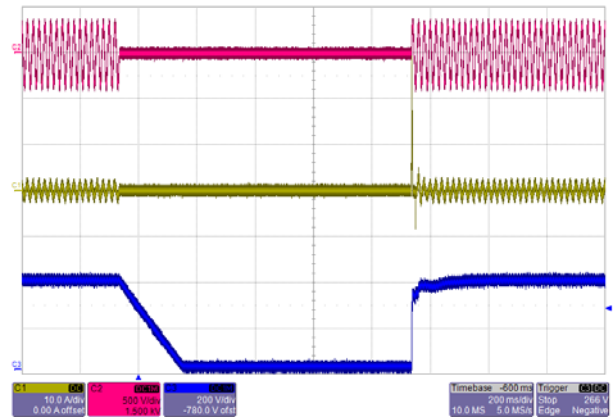
**Figure 34** – Transient Response, 264 VAC, 50–100–50% Load Step.  
 Top: Input Voltage, 1 KV / div.  
 Second: Input Current, 5 A / div.  
 Third: Output Voltage (AC Coupled), 50 V / div.  
 Bottom: Load Current 1 A, 100 ms / div.

**10.11 1000 ms Line Dropout (115 VAC / 60 Hz and 230 VAC / 50 Hz)**

10.11.1 50% Load at Output



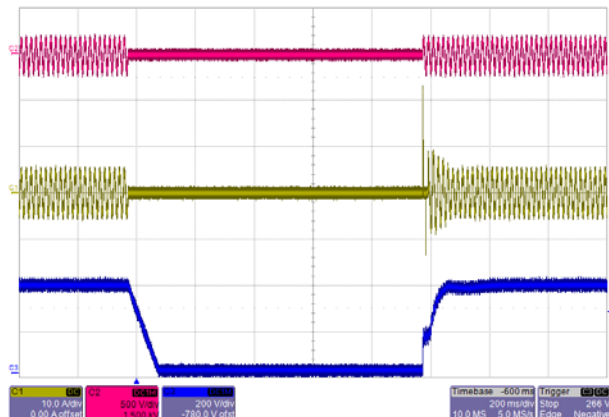
**Figure 35** – Line Dropout 115 VAC, 1000 ms.  
 Top: Input Voltage, 500 V / div.  
 Middle: Input Current, 10 A / div.  
 Bottom: Output Voltage, 200 V, 200 ms / div.



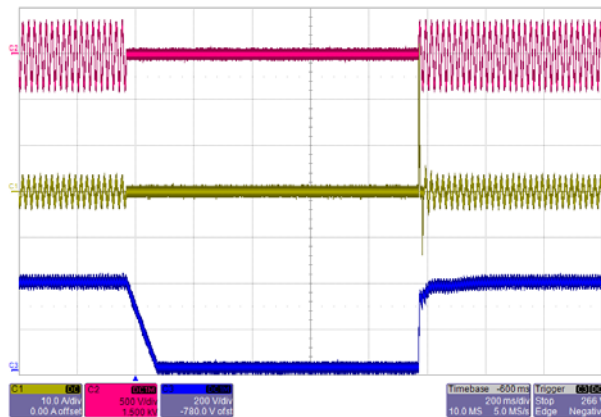
**Figure 36** – Line Dropout 230 VAC, 1000 ms.  
 Top: Input Voltage, 500 V / div.  
 Middle: Input Current, 10 A / div.  
 Bottom: Output Voltage, 200 V, 200 ms / div.



10.11.2 Full Load at Output



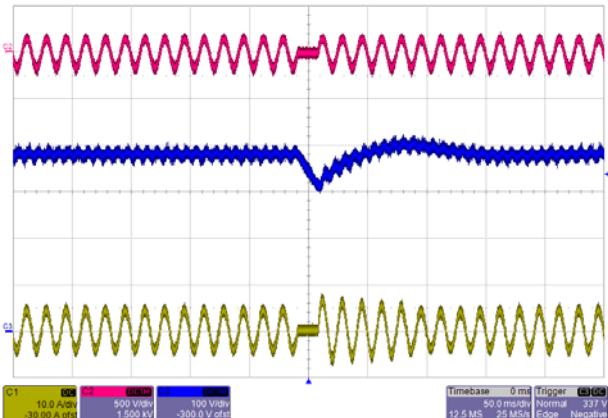
**Figure 37** – Line Dropout 115 VAC, 1000 ms.  
 Top: Input Voltage, 500 V / div.  
 Middle: Input Current, 10 A / div.  
 Bottom: Output Voltage, 200 V,  
 200 ms / div.



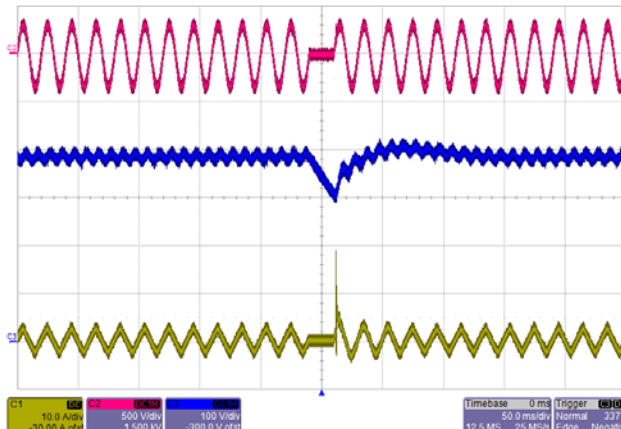
**Figure 38** – Line Dropout 230 VAC, 1000 ms.  
 Top: Input Voltage, 500 V / div.  
 Middle: Input Current, 10 A / div.  
 Bottom: Output Voltage, 200 V,  
 200 ms / div.

10.12 One Cycle Line Dropout (115 VAC / 60 Hz and 230 VAC / 50 Hz)

10.12.1 Full Load at Output



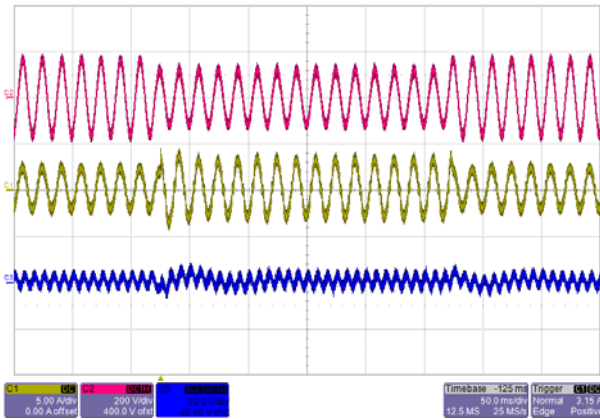
**Figure 39** – Line Dropout 115 VAC, 60 Hz  
 Top: Input Voltage, 500 V / div.  
 Middle: Output Voltage, 100 V / div.  
 Bottom: Input Current, 10 A, 50 ms / div.



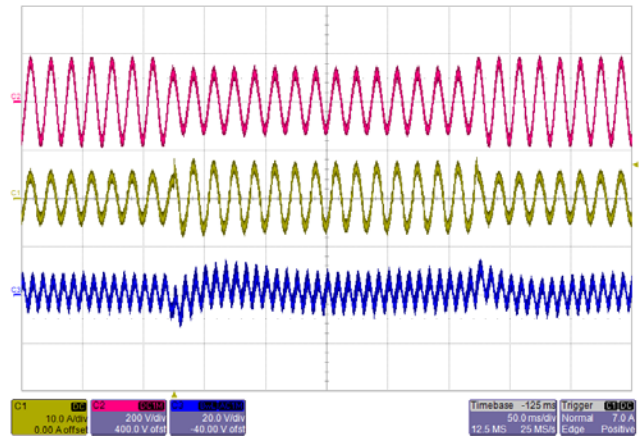
**Figure 40** – Line Dropout 230 VAC, 50 Hz  
 Top: Input Voltage, 500 V / div.  
 Middle: Output Voltage, 100 V / div.  
 Bottom: Input Current, 10 A, 50 ms / div.



**10.13 Line Sag (115 VAC – 85 VAC – 115 VAC, 60 Hz)**

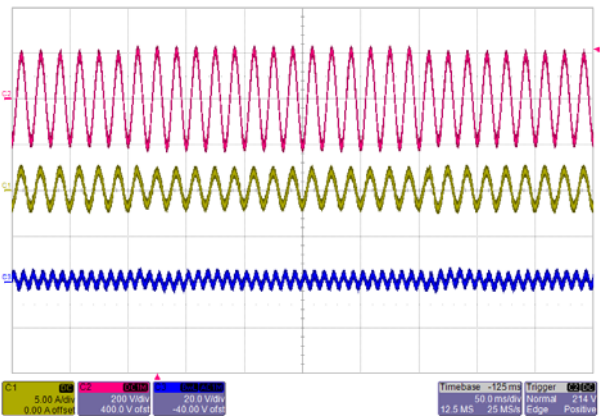


**Figure 41** – Line Sag 115 VAC, 50% Load.  
 Top: Input Voltage, 200 V / div.  
 Middle: Input Current, 5 A, 50 ms / div.  
 Bottom: Output Voltage (AC Coupled), 20 V / div.

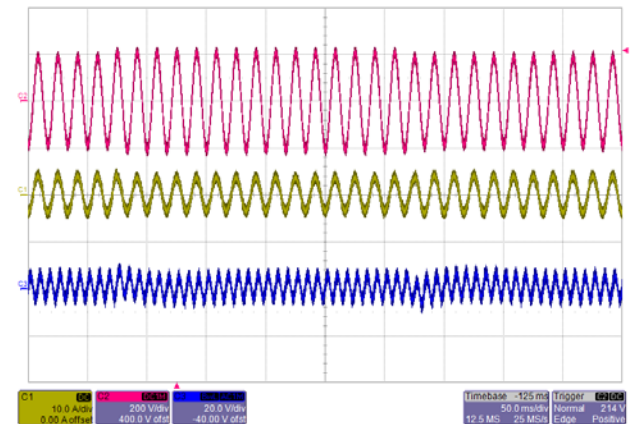


**Figure 42** – Line Sag 115 VAC, 100% Load.  
 Top: Input Voltage, 200 V / div.  
 Middle: Input Current, 10 A, 50 ms / div.  
 Bottom: Output Voltage (AC Coupled), 20 V / div.

**10.14 Line Surge (132 VAC – 147 VAC – 132 VAC, 60 Hz)**



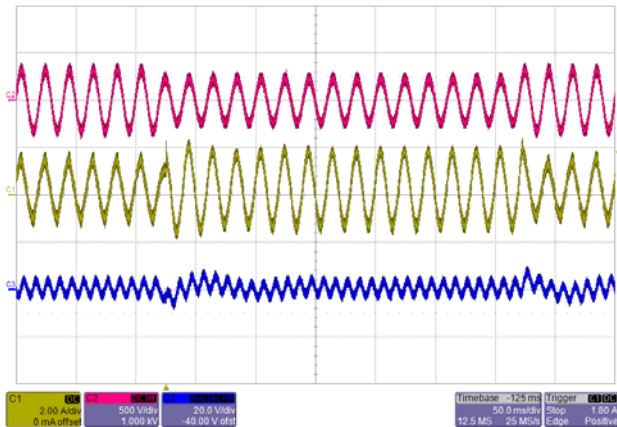
**Figure 43** – Line Surge 132 VAC, 50% Load.  
 Top: Input Voltage, 200 V / div.  
 Middle: Input Current, 5 A, 50 ms / div.  
 Bottom: Output Voltage (AC Coupled), 20 V / div.



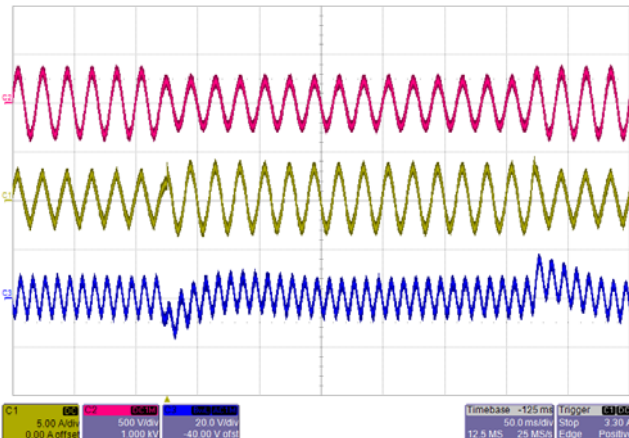
**Figure 44** – Line Surge 132 VAC, 100% Load.  
 Top: Input Voltage, 200 V / div.  
 Middle: Input Current, 10 A, 50 ms / div.  
 Bottom: Output Voltage (AC Coupled), 20 V / div.



**10.15 Line Sag (230 VAC – 170 VAC – 230 VAC, 50 Hz)**

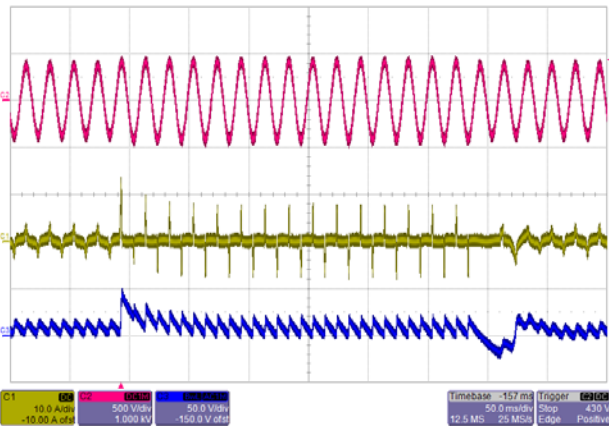


**Figure 45** – Line Sag 230 VAC, 50% Load.  
 Top: Input Voltage, 500 V / div.  
 Middle: Input Current, 2 A, 50 ms / div.  
 Bottom: Output Voltage (AC Coupled),  
 20 V / div.

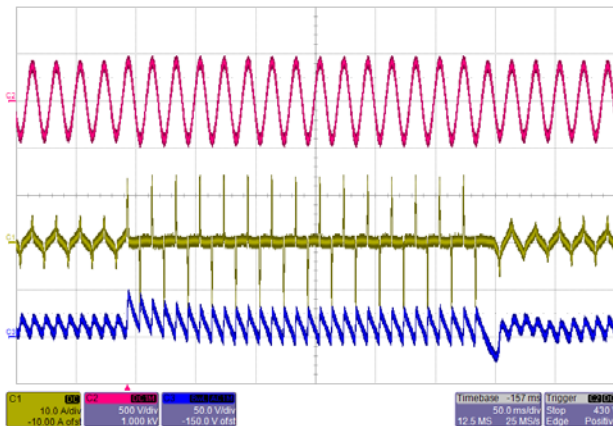


**Figure 46** – Line Sag 230 VAC, 100% Load.  
 Top: Input Voltage, 500 V / div.  
 Middle: Input Current, 5 A, 50 ms / div.  
 Bottom: Output Voltage (AC Coupled),  
 20 V / div

**10.16 Line Surge (264 VAC – 293 VAC – 264 VAC, 50 Hz)**



**Figure 47** – Line Surge 264 VAC, 50% Load.  
 Top: Input Voltage, 500 V / div.  
 Middle: Input Current, 10 A, 50 ms / div.  
 Bottom: Output Voltage (AC Coupled),  
 50 V / div.



**Figure 48** – Line Surge 264 VAC, 100% Load.  
 Top: Input Voltage, 500 V / div.  
 Middle: Input Current, 10 A, 50 ms / div.  
 Bottom: Output Voltage (AC Coupled),  
 50 V / div.



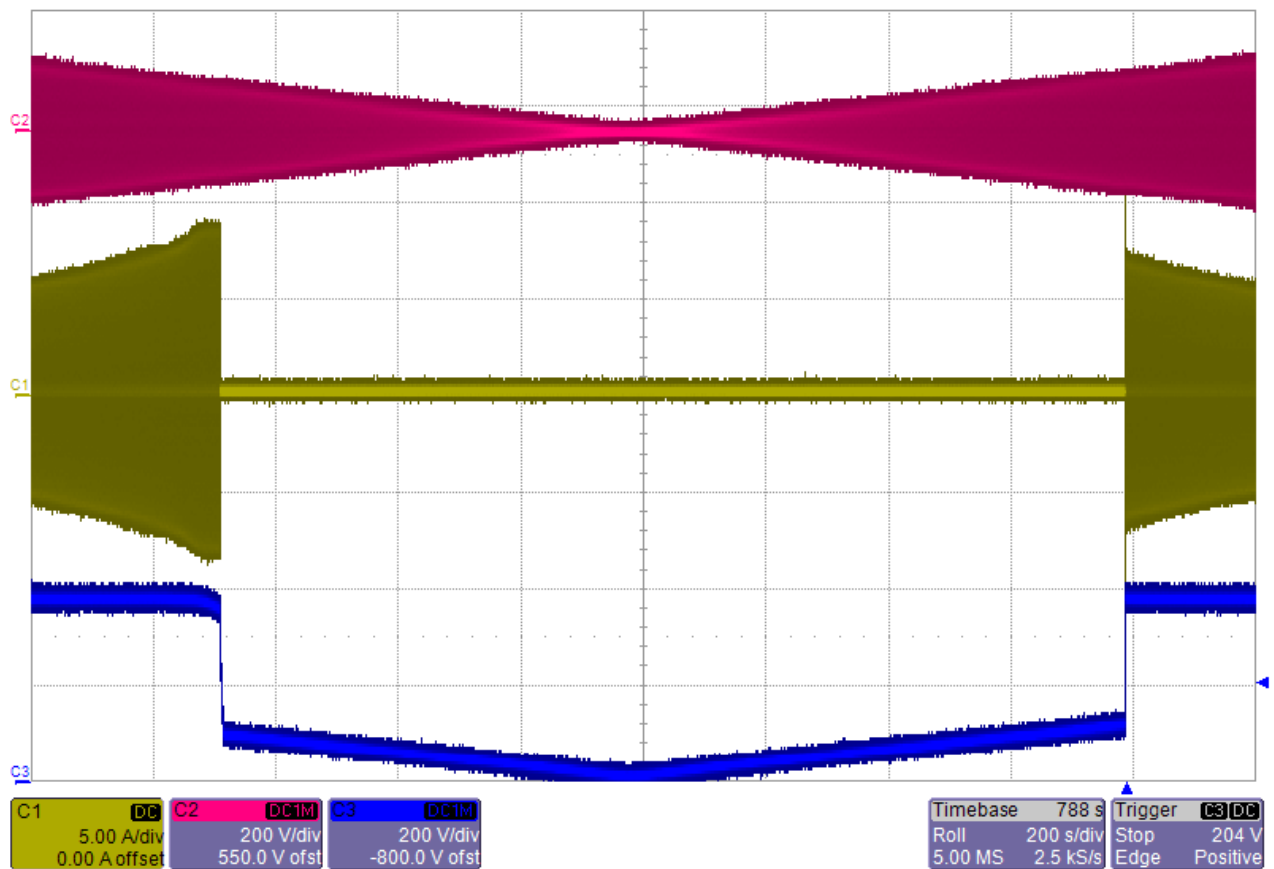


**10.17 Brown-Out and Brown-In at 6 V / Minute Rate**

Test conducted with reduction followed by increase of input voltage at the rate of 6 V/min. The DC output was connected to full load (electronic load) and it was programmed to unload at brown-out. A resistor of 17 kΩ was also connected at output to discharge the output capacitor of the PFC after brown-out. This resistor represents any auxiliary supply powered from the PFC output.

Measured Brown-Out Threshold            69.9 VAC  
 Measured Brown-In Threshold            78.1 VAC

**Note:** Operation at low input voltages results in higher power dissipation in many components on the board. Forced air cooling is necessary during this test.



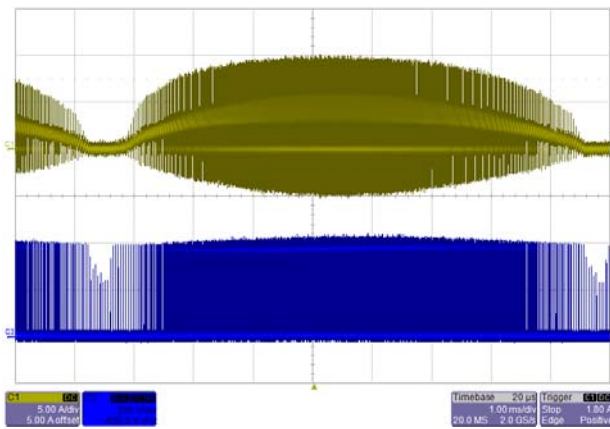
**Figure 49** – Brown-Out Followed by Brown-In at 100% Load.  
 Top: Input Voltage, 200 V / div.  
 Middle: Input Current, 5 A, 200 s / div.  
 Bottom: Output Voltage, 200 V / div.



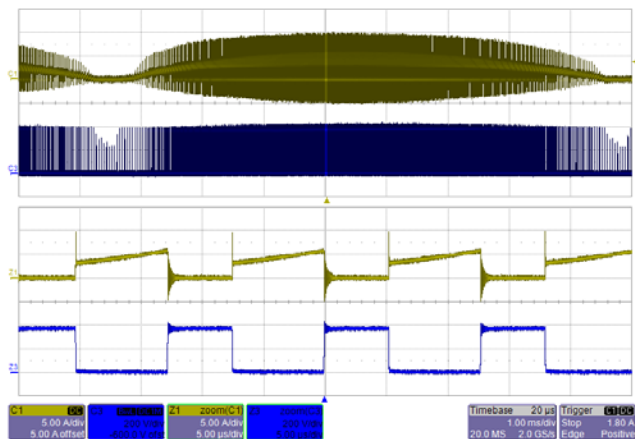
### 10.18 Drain Voltage and Current

The drain current was measured at Jumper JP4 location by replacing JP4 with a very short wire loop in order to insert the current probe. The drain voltage was measured at the Drain and Source pins of IC U1. Do not make the wire loop very large since the added inductance at the drain node can cause very large inductance spike and lead to very high  $V_{ds}$  voltage that could damage U1, therefore, we do not recommend breaking JP4 to measure the drain–source current. However, the drain–source current can be obtained from the inductor L5 current through some calculations. Please see Appendix C for output inductor current measurement setup and calculations.

#### 10.18.1 Dain Voltage and Current at 115 VAC Input and Full Load



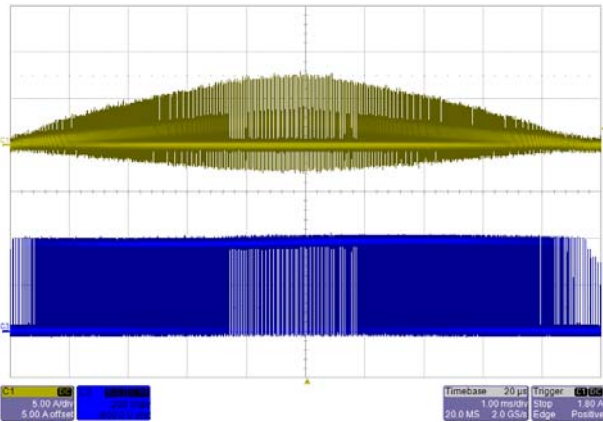
**Figure 50** – Input Voltage 115 VAC, 100% Load.  
Top: Drain Current, 5 A, 1 ms / div.  
Bottom: Drain Voltage, 200 V / div.



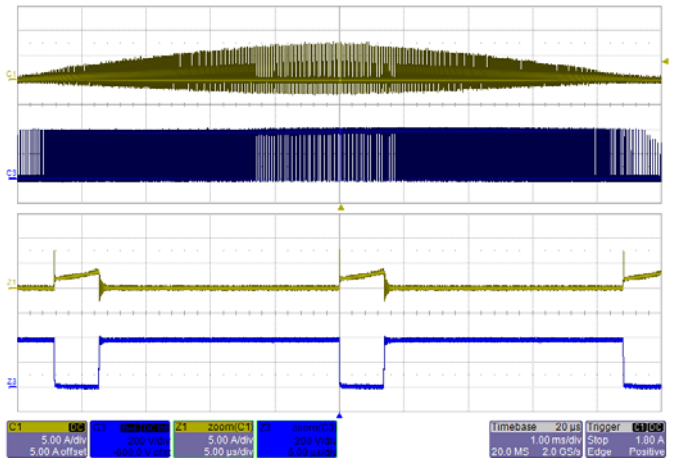
**Figure 51** – Input Voltage 115 VAC, 100% Load.  
Top: Drain Current, 5 A, 1 ms / div.  
Bottom: Drain Voltage, 200 V / div.  
Zoom Top: Drain Current, 5 A, 5  $\mu$ s / div.  
Zoom Bottom: Drain Voltage, 200 V / div.



10.18.2 Drain Voltage and Current at 230 VAC Input and Full Load



**Figure 52** – Input Voltage 230 VAC, 100% Load.  
 Top: Drain Current, 5 A, 1 ms / div.  
 Bottom: Drain Voltage, 200 V / div.



**Figure 53** – Input Voltage 230 VAC, 100% Load.  
 Top: Drain Current, 5 A, 1 ms / div.  
 Bottom: Drain Voltage, 200 V / div.  
 Zoom Top: Drain Current, 5 A, 5 μs / div.  
 Zoom Bottom: Drain Voltage, 200 V / div.

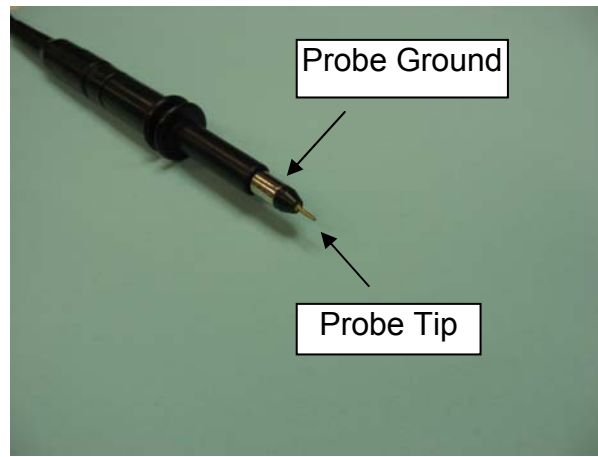


## 10.19 Output Ripple Measurements

### 10.19.1 Ripple Measurement Technique

For DC output ripple measurements, a modified oscilloscope test probe must be utilized in order to reduce spurious signals due to pickup. Details of the probe modification are provided in the figures below.

The 4987BA probe adapter is affixed with one capacitor 0.02  $\mu\text{F}$ /1 kV ceramic disc type tied in parallel across the probe tip.

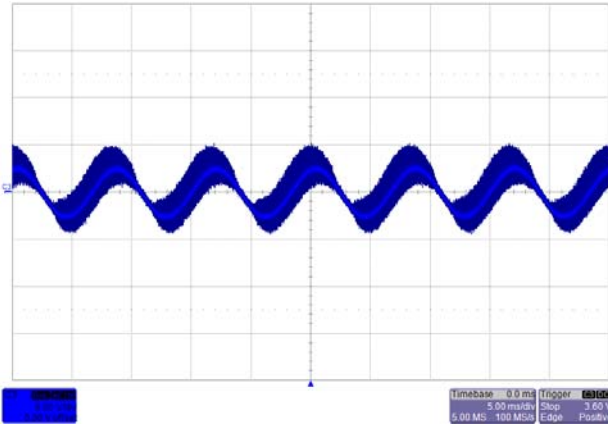


**Figure 54** – Oscilloscope Probe Prepared for Ripple Measurement (End Cap and Ground Lead Removed).

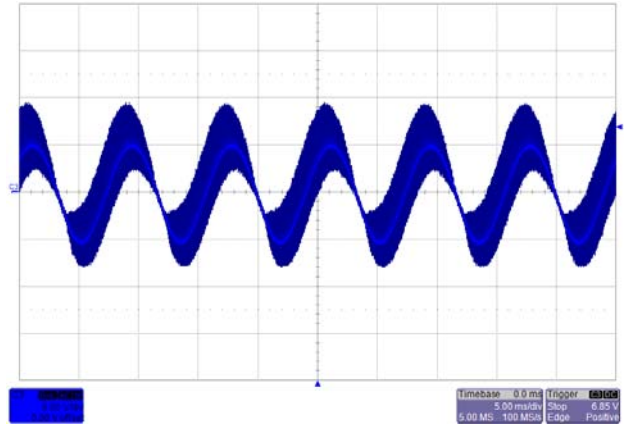


**Figure 55** – Oscilloscope Probe with Probe Master ([www.probemaster.com](http://www.probemaster.com)) 4987A BNC Adapter. Modified with wires for ripple measurement, and one parallel decoupling capacitor added.)

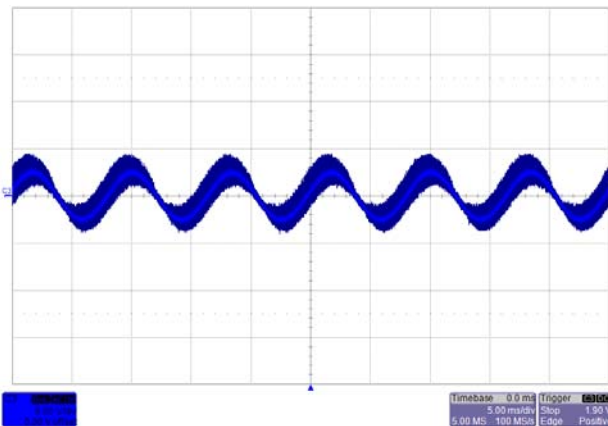
10.19.2 Measurement Results



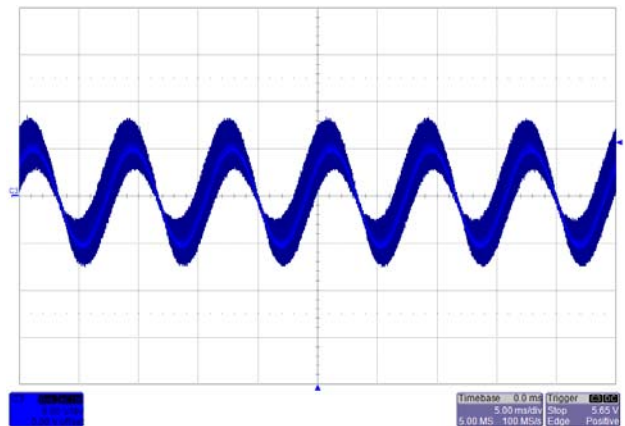
**Figure 56** – Ripple, 90 VAC, 50% Load.  
5 ms, 5 V / div.



**Figure 57** – Ripple, 90 VAC, 100% Load.  
5 ms, 5 V / div.

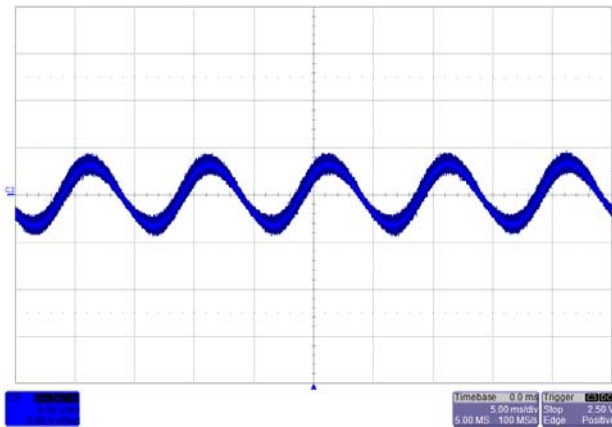


**Figure 58** – Ripple, 115 VAC, 50% Load.  
5 ms, 5 V / div.

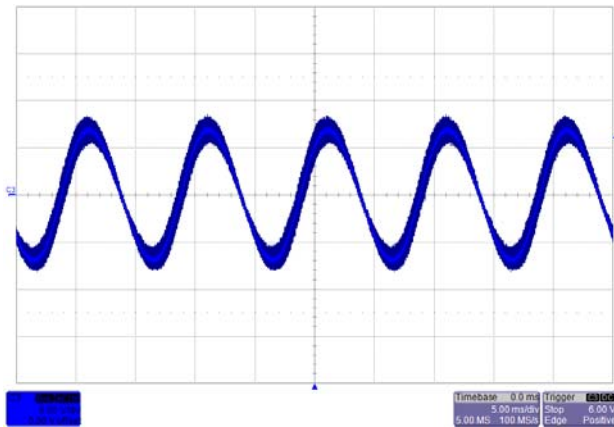


**Figure 59** – Ripple, 115 VAC, 100% Load.  
5 ms, 5 V / div.

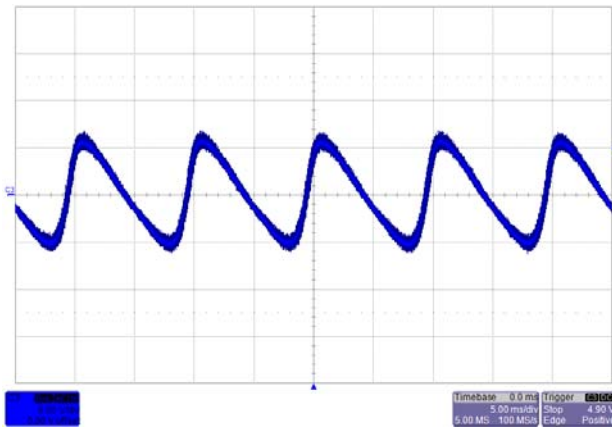




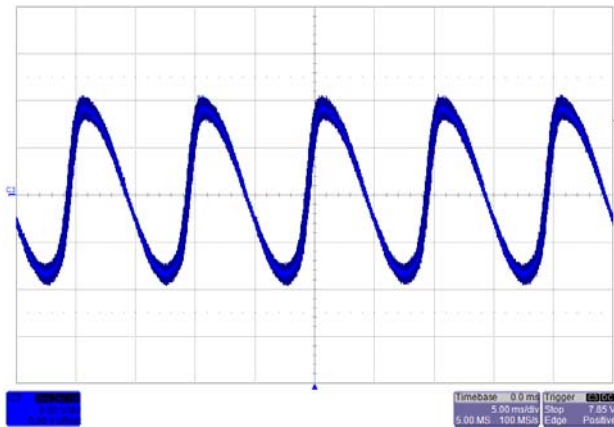
**Figure 60** – Ripple, 230 VAC, 50% Load.  
5 ms, 5 V / div.



**Figure 61** – Ripple, 230 VAC, 100% Load.  
5 ms, 5 V / div.



**Figure 62** – Ripple, 264 VAC, 50% Load.  
5 ms, 5 V / div.



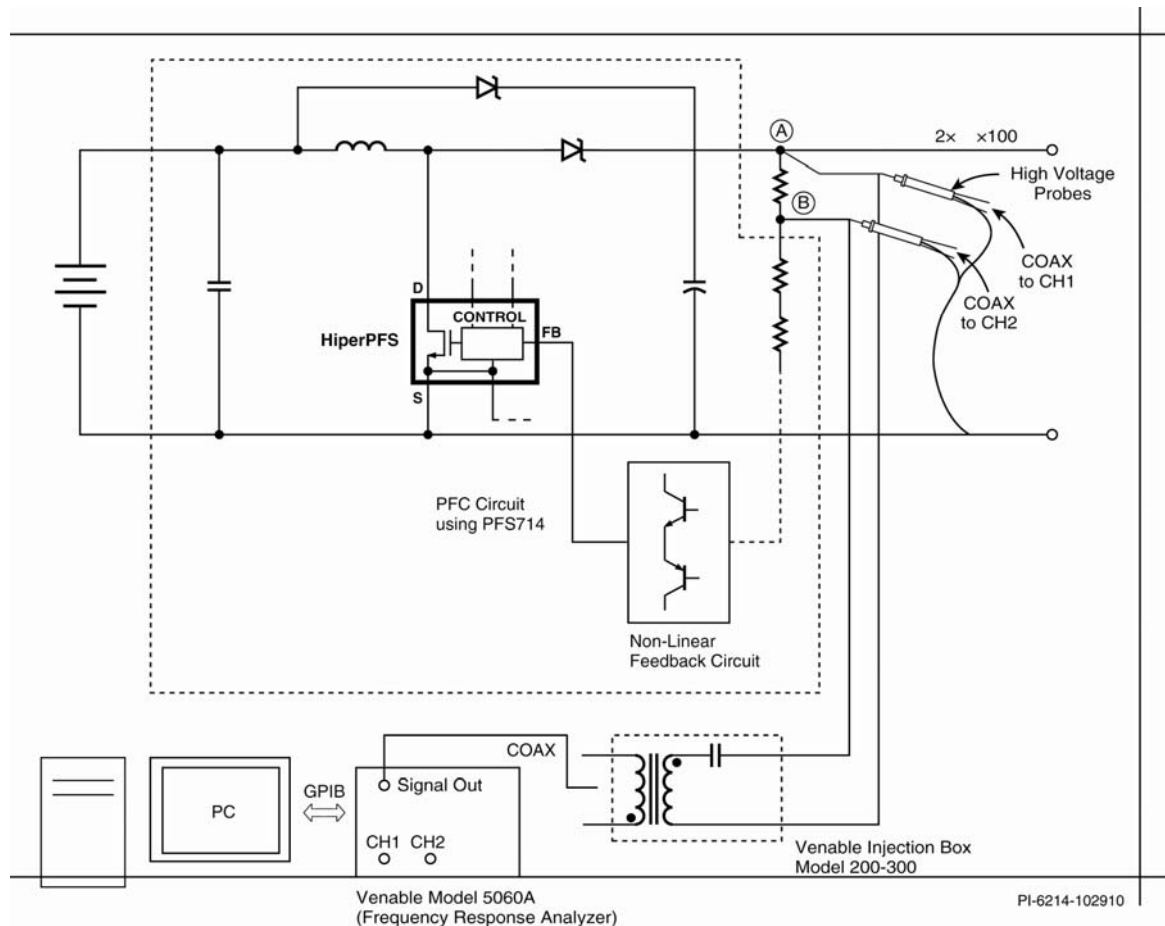
**Figure 63** – Ripple, 264 VAC, 100% Load.  
5 ms, 5 V / div.

## 11 Gain–Phase Measurement Procedure and Results

- The PFC stage is supplied from an adjustable DC source for this test. Connect the circuit as shown in Figure 64. Open the top end of the feedback divider network and insert a  $100\Omega$ – $2W$  resistor in series as shown. The signal injected in the loop for gain–phase measurement will be injected across this resistor.
- Nodes A and B (two ends of the injection resistor) are connected to Channel 1 and Channel 2 of the frequency response analyzer using high voltage  $\times 100$  attenuator probes. GND leads of both probes are connected to output return as shown.
- The signal to be injected is isolated using the Bode–Box injection transformer model – 200–000 from Venable Industries.

### Test Procedure:

- Adjust the input voltage to 150 VDC and confirm that the PFC output voltage is within regulation limits.
- Inject a signal from the frequency response analyzer.
- The injected signal can be seen in the output voltage ripple of the PFC.
- Plot the gain phase pot by sweeping the injected signal frequency from 3 Hz to 90 Hz



**Figure 64** – System Test Setup for Loop Gain–Phase Measurement.

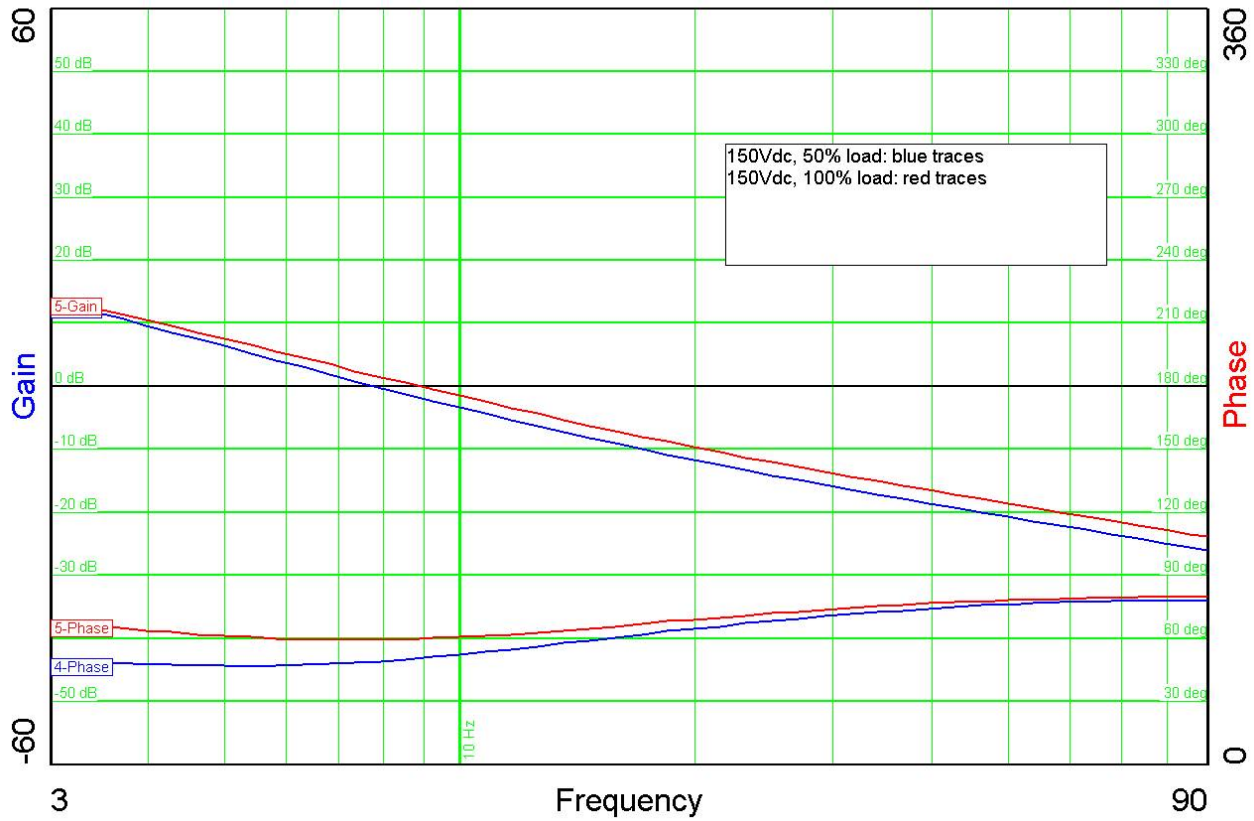


Figure 65 – Bode Plot with 150 VDC, 50% and 100% Load.

Note: phase margin is greater than 45 deg.





## 12 Line Surge Test

| Surge Level (V) | Input Voltage (VAC) | Injection Location  | Injection Phase (°) | Test Results (Pass/Fail # Strikes) |
|-----------------|---------------------|---------------------|---------------------|------------------------------------|
| <b>C.M.</b>     |                     | <b>(12Ω source)</b> |                     | <b>10 Strikes each Level</b>       |
| +500            | 230                 | L1 to PE            | 90                  | Pass                               |
| -500            | 230                 | L1 to PE            | 270                 | Pass                               |
| +500            | 230                 | L2 to PE            | 270                 | Pass                               |
| -500            | 230                 | L2 to PE            | 90                  | Pass                               |
| +500            | 230                 | L1, L2 to PE        | 90 <sup>1</sup>     | Pass                               |
| -500            | 230                 | L1, L2 to PE        | 90                  | Pass                               |
| <b>D.M.</b>     |                     | <b>(2Ω source)</b>  |                     |                                    |
| +500            | 230                 | L1 to L2            | 90 <sup>2</sup>     | Pass                               |
| -500            | 230                 | L1 to L2            | 270                 | Pass                               |
| <b>C.M.</b>     |                     | <b>(12Ω source)</b> |                     |                                    |
| +1000           | 230                 | L1 to PE            | 90                  | Pass                               |
| -1000           | 230                 | L1 to PE            | 270                 | Pass                               |
| +1000           | 230                 | L2 to PE            | 270                 | Pass                               |
| -1000           | 230                 | L2 to PE            | 90                  | Pass                               |
| +1000           | 230                 | L1, L2 to PE        | 90 <sup>1</sup>     | Pass                               |
| -1000           | 230                 | L1, L2 to PE        | 90                  | Pass                               |
| <b>D.M.</b>     |                     | <b>(2Ω source)</b>  |                     |                                    |
| +1000           | 230                 | L1 to L2            | 90 <sup>2</sup>     | Pass                               |
| -1000           | 230                 | L1 to L2            | 270                 | Pass                               |
| <b>C.M.</b>     |                     | <b>(12Ω source)</b> |                     | <b>10 Strikes each Level</b>       |
| +1500           | 230                 | L1 to PE            | 90                  | Pass                               |
| -1500           | 230                 | L1 to PE            | 270                 | Pass                               |
| +1500           | 230                 | L2 to PE            | 270                 | Pass                               |
| -1500           | 230                 | L2 to PE            | 90                  | Pass                               |
| +1500           | 230                 | L1, L2 to PE        | 90 <sup>1</sup>     | Pass                               |
| -1500           | 230                 | L1, L2 to PE        | 90                  | Pass                               |
| <b>C.M.</b>     |                     | <b>(12Ω source)</b> |                     | <b>10 Strikes each Level</b>       |
| +2000           | 230                 | L1 to PE            | 90                  | Pass                               |
| -2000           | 230                 | L1 to PE            | 270                 | Pass                               |
| +2000           | 230                 | L2 to PE            | 270                 | Pass                               |
| -2000           | 230                 | L2 to PE            | 90                  | Pass                               |
| +2000           | 230                 | L1, L2 to PE        | 90 <sup>1</sup>     | Pass                               |
| -2000           | 230                 | L1, L2 to PE        | 90                  | Pass                               |

<sup>1</sup> Note: 0° and 270° phase angle [relative to L1] was not tested; however, negative voltage polarity was performed at 90° phase angle for worst case total negative pulse on alternate phase [neutral].

<sup>2</sup> Note: 0° and 270° phase angle [relative to L1] was not tested on both polarities; however, negative voltage polarity was performed at 270° phase angle for worst case total negative pulse on alternate phase [neutral].



### 13 EMI Scans

#### 13.1 EMI Test Set-up

Use a plexi-glass board with complete copper coated on one side, connect the copper side of the board to test point TP8 with a wire clip. A RD-91 board was used here to provide  $V_{CC}$  input to RD-236 board. Both boards should sit on top of the plexi-glass board. Connect TP1/TP2 & TP6/TP7 test point pairs from RD-236 board to J1/J2 & J3/J4 test point pairs of the RD-91 board respectively. Connect the load to J2 2-pin header. All connections should be made as short as possible. See Figure 66 for set-up.



Figure 66 – EMI Test Set-up.

### 13.2 EMI Scans

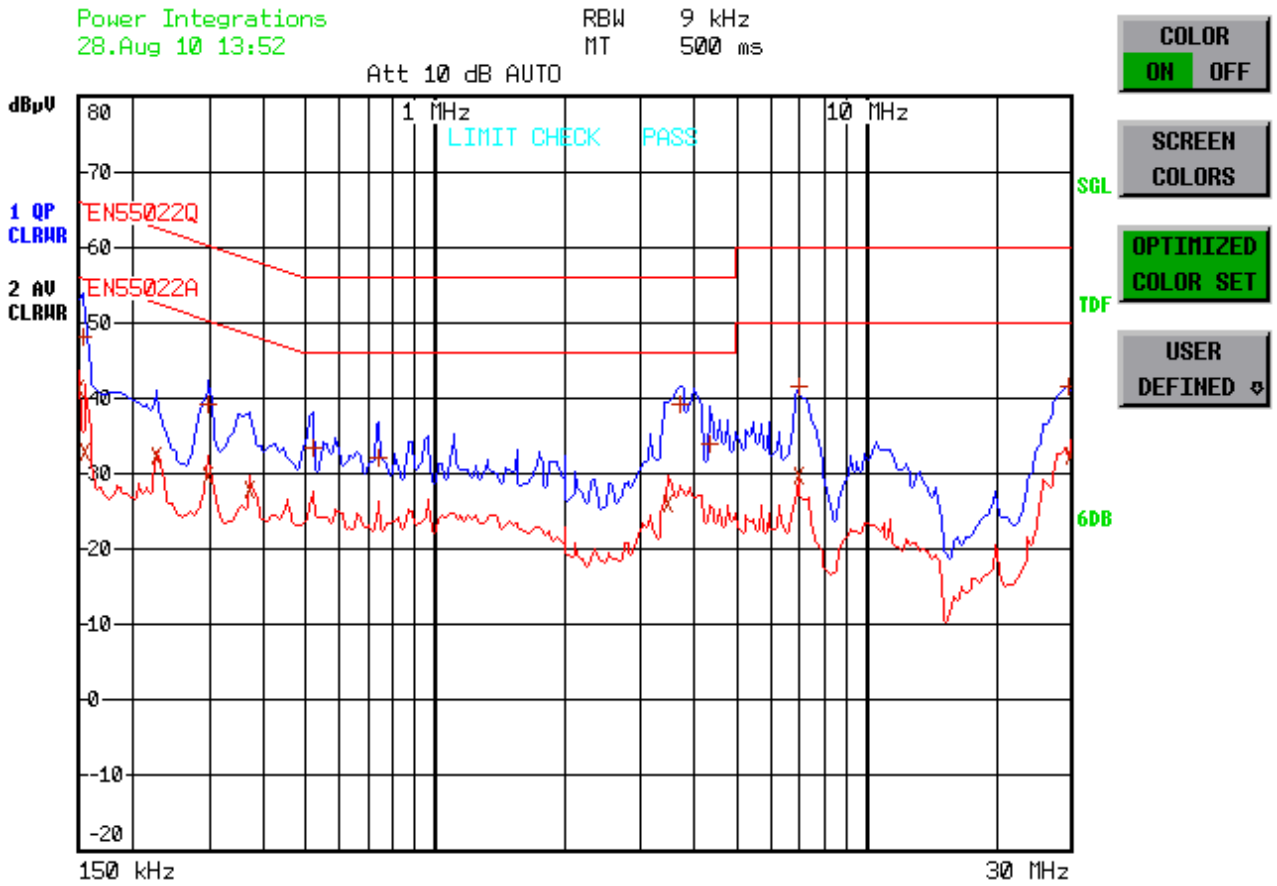


Figure 67 – 115 VAC, 100% Load.

| TRACE        | FREQUENCY         | LEVEL dBµV   | DELTA LIMIT dB |
|--------------|-------------------|--------------|----------------|
| Trace1:      | EN55022Q          |              |                |
| Trace2:      | EN55022A          |              |                |
| Trace3:      | ---               |              |                |
| 2 Average    | 150 kHz           | 41.38 L1 gnd | -14.61         |
| 1 Quasi Peak | 153 kHz           | 48.13 L1 gnd | -17.70         |
| 2 Average    | 156.06 kHz        | 32.78 L1 gnd | -22.88         |
| 2 Average    | 227.349951585 kHz | 32.24 N gnd  | -20.30         |
| 1 Quasi Peak | 299.983432899 kHz | 39.09 N gnd  | -21.14         |
| 2 Average    | 299.983432899 kHz | 29.86 N gnd  | -20.38         |
| 2 Average    | 372.991693411 kHz | 27.77 N gnd  | -20.66         |
| 1 Quasi Peak | 522.278418129 kHz | 33.32 N gnd  | -22.67         |
| 1 Quasi Peak | 745.942190883 kHz | 32.10 N gnd  | -23.90         |
| 2 Average    | 3.49557455365 MHz | 26.18 N gnd  | -19.81         |
| 1 Quasi Peak | 3.70953168093 MHz | 39.12 N gnd  | -16.87         |
| 1 Quasi Peak | 4.34630759308 MHz | 33.84 N gnd  | -22.15         |
| 1 Quasi Peak | 6.99076303039 MHz | 41.60 L1 gnd | -18.39         |
| 2 Average    | 6.99076303039 MHz | 29.64 L1 gnd | -20.35         |
| 1 Quasi Peak | 29.6713372241 MHz | 41.47 L1 gnd | -18.52         |
| 2 Average    | 30 MHz            | 32.41 L1 gnd | -17.59         |

Figure 68 – 115 VAC, 100% Load EMI Measurement Results.



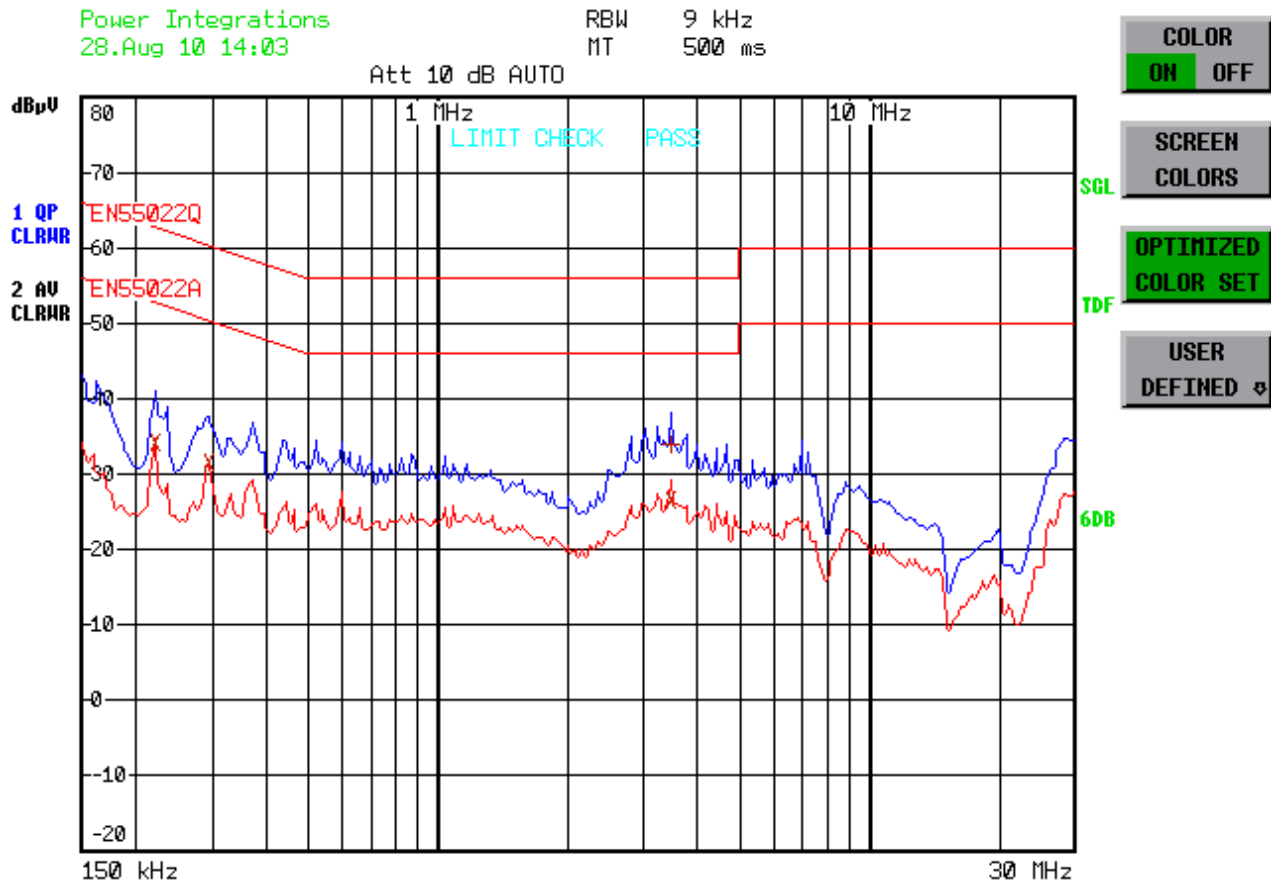


Figure 69 – 230 VAC, 100% Load.

|              |                   |             |                |
|--------------|-------------------|-------------|----------------|
| Trace1:      | EN55022Q          |             |                |
| Trace2:      | EN55022A          |             |                |
| Trace3:      | ---               |             |                |
| TRACE        | FREQUENCY         | LEVEL dBµV  | DELTA LIMIT dB |
| 2 Average    | 222.892109397 kHz | 34.13 N gnd | -18.57         |
| 2 Average    | 294.101404803 kHz | 31.65 N gnd | -18.75         |
| 1 Quasi Peak | 3.49557455365 MHz | 33.89 N gnd | -22.11         |
| 2 Average    | 3.49557455365 MHz | 26.64 N gnd | -19.35         |

Figure 70– 230 VAC, 100% Load EMI Measurement Results

### 14 Appendix A – Efficiency with Other Diodes and Core Materials

Use of Silicon Carbide Schottky diodes for PFC output can provide higher efficiency. Graph below shows efficiency improvement due to use of C3D06060A instead of the ultrafast STTH8S06D diode.

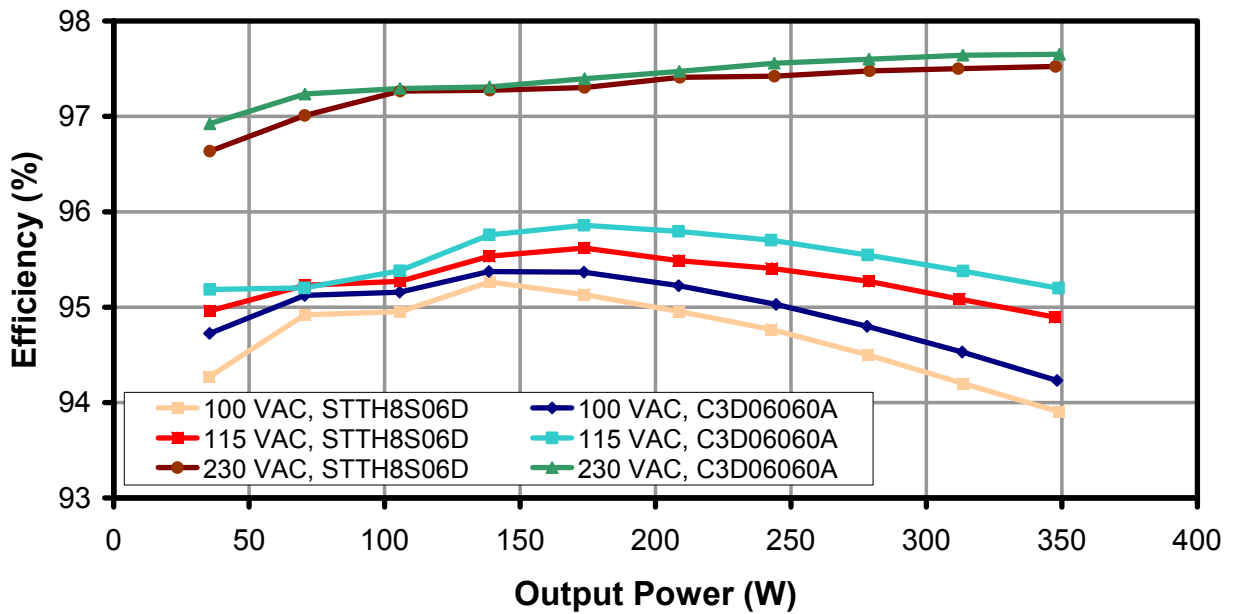


Figure 71 – Efficiency, Silicon Carbide Schottky C3D06060A vs. Ultra Fast STTH8S06D (Reference) Diode.



Choice of inductor material and inductor design affects PFC efficiency at light load. At lighter load levels, the PFC runs in discontinuous mode for significant portion of the input waveform which increases core losses. The example below shows effect of change of core material.

- 77324 is Magnetics Inc. Kool-Mu Material
- 55324 is Magnetics Inc. MPP Material
- 58324 is Magnetics Inc. High flux Material

Material choice is often a price / performance tradeoff.

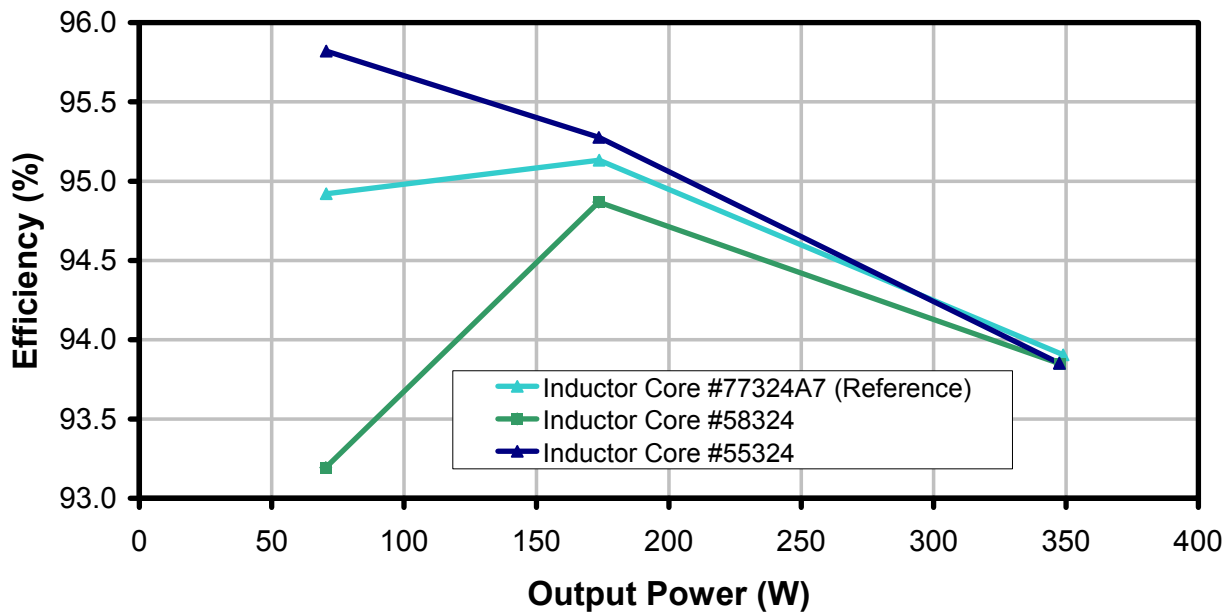


Figure 72 – Efficiency with Other Inductor Cores at 100 VAC.

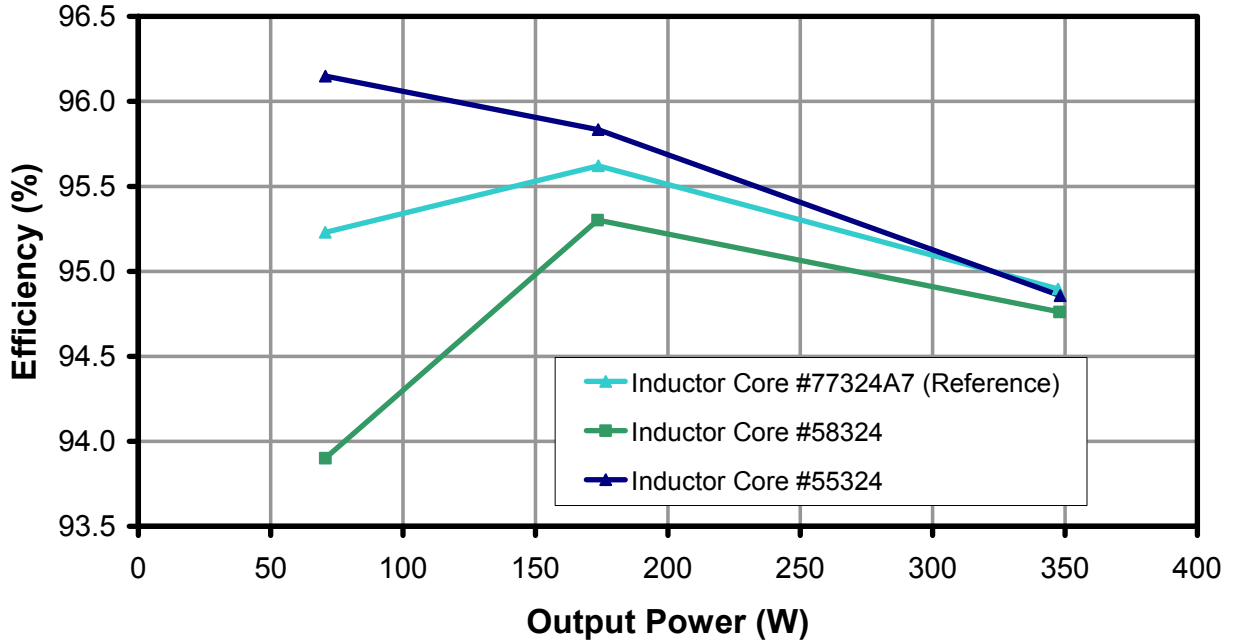


Figure 73 – Efficiency with Other Inductor Cores at 115 VAC.



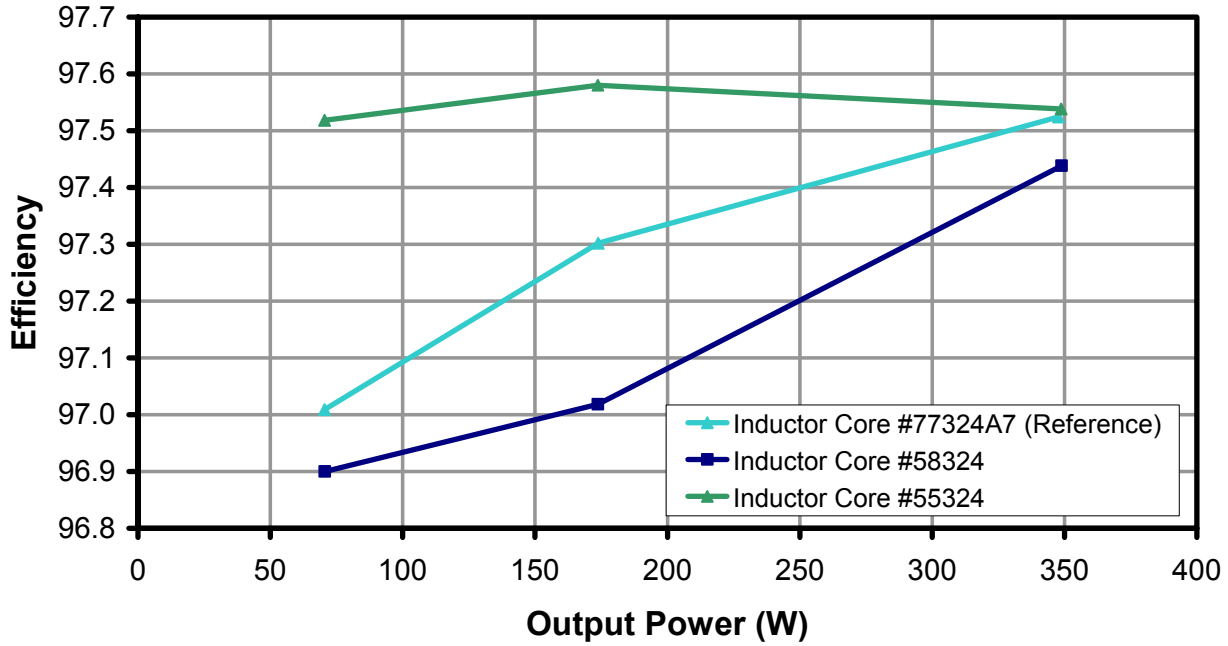
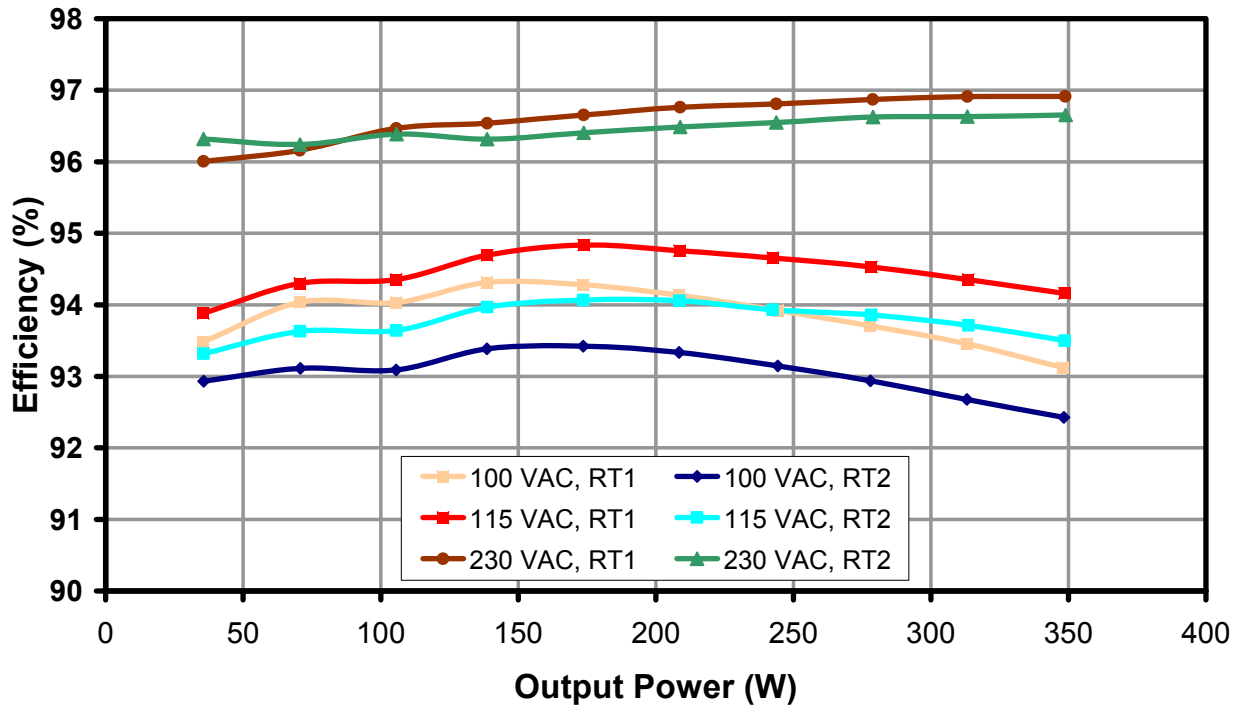


Figure 74 – Efficiency with Other Inductor Cores at 230 VAC.







**Figure 75** – Efficiency with Thermistor RT1 or RT2 in Circuit vs. Output Power.

Note: this is the PFC efficiency plot with thermistor RT1 in-circuit (RT1 shorting pads open and RT2 pads shorted), and thermistor RT2 in-circuit (RT2 pads open and RT1 pads shorted). The additional voltage drop in series with diode D2 or input line due to thermistor RT1 and RT2 degrade efficiency. By default, RT1 is shorted on the RD-236 board when shipped.

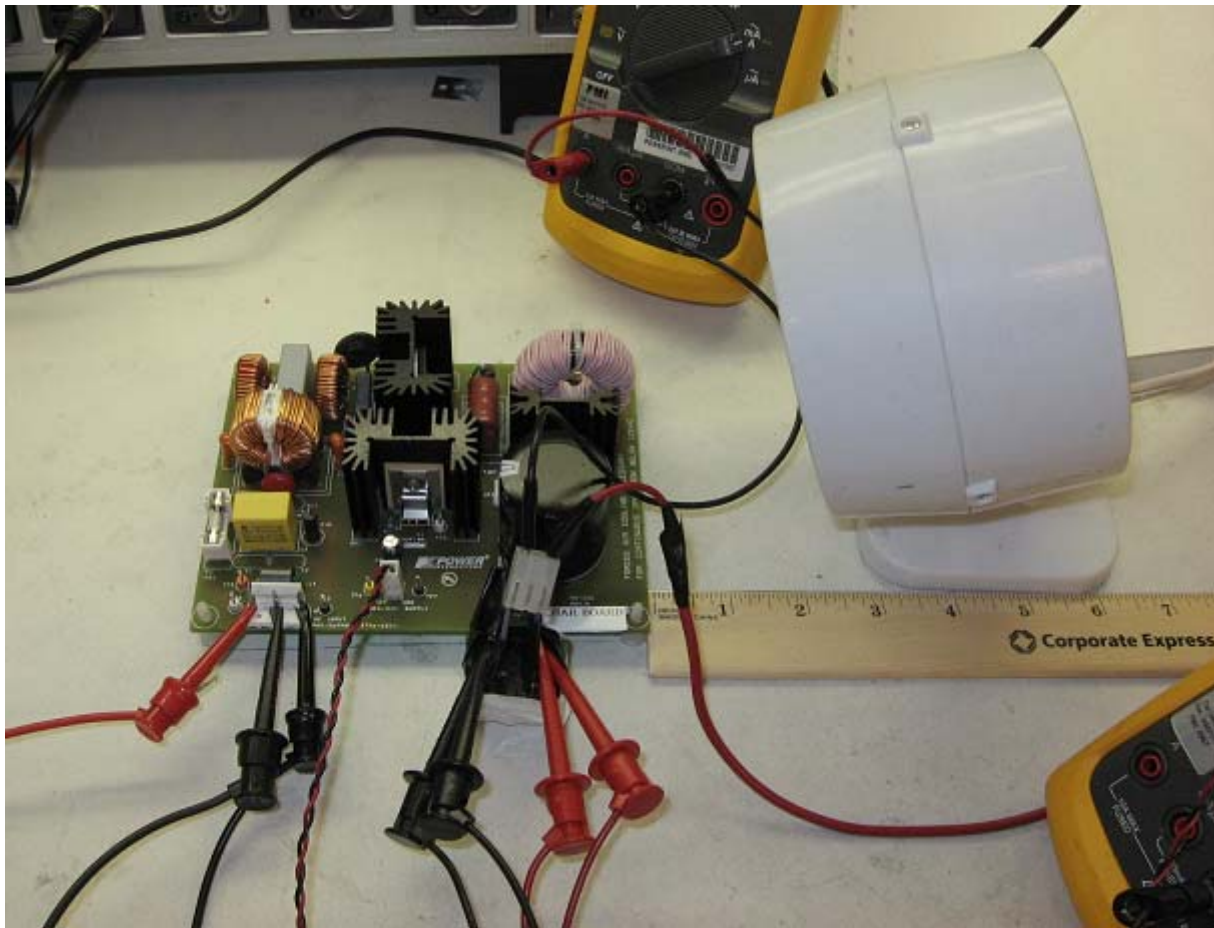
*Note: In most applications, a relay will be used to bypass the thermistor RT2 after start up in order to improve system efficiency.*



## 15 Appendix B – Test Set-up for Efficiency Measurement

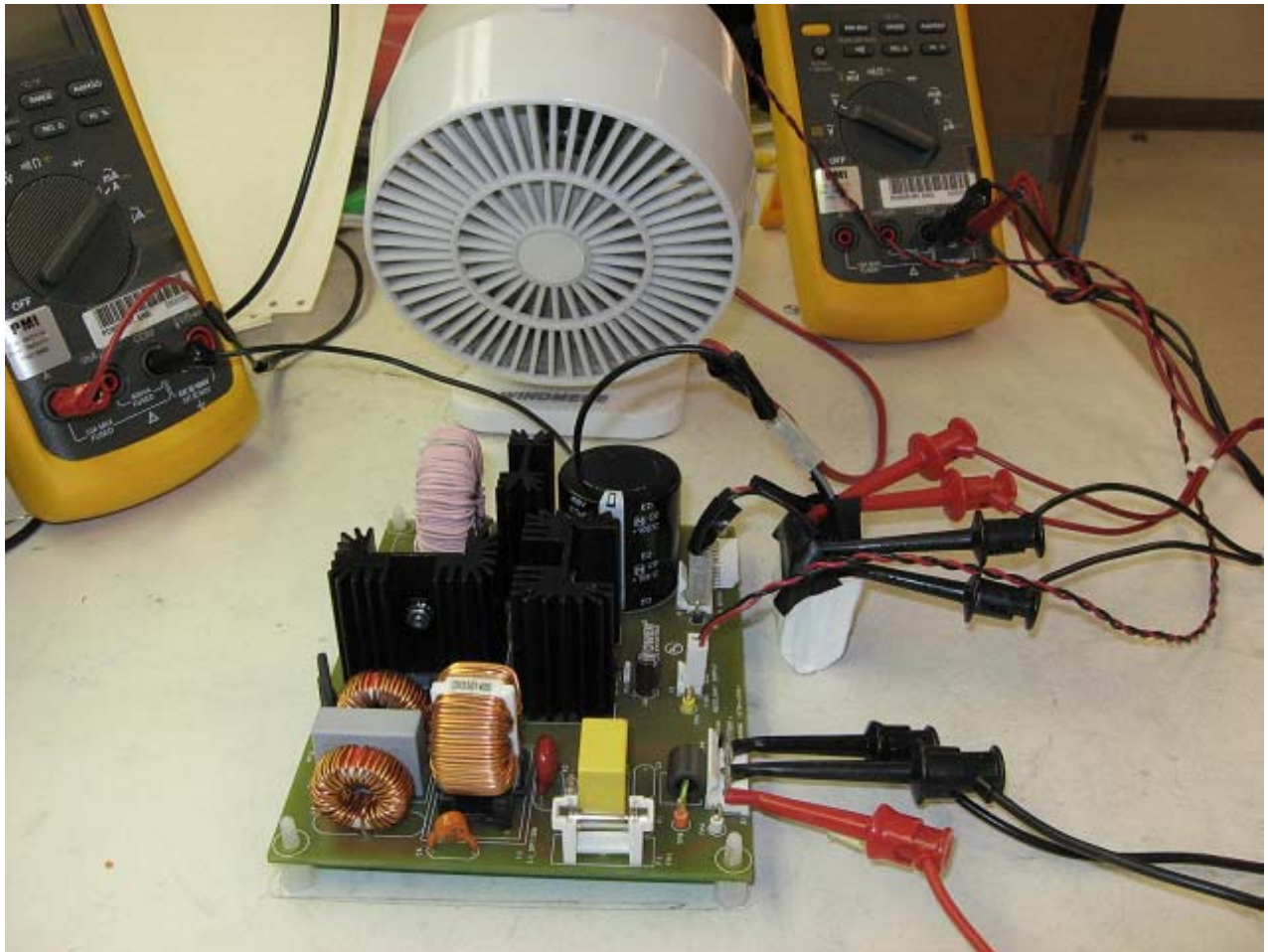
RD-236 is designed for continuous operation with full load only for a nominal voltage of 115 VAC. For performance evaluation at input voltage levels below the nominal input voltage, forced air cooling is necessary.

The following setup is recommended for system efficiency, PF and THD measurements. A 4.75" diameter AC fan is placed about 3" away from the right-side edge of the RD-236 board, in high speed position. Use high resolution meters for output current and output voltage measurements. See figures below for board and fan positions



**Figure 76** – Front View of the Test Setup for Efficiency, PF and THD Measurements.





**Figure 77** – Side View of the Test Setup for Efficiency, PF and THD Measurements.



### 16 Appendix C – Inductor Current Measurement Set-up

The output inductor current can be measured at jumper JP5 location. Simply replace JP5 with a very short wire-loop in order to insert the current probe. Attach the oscilloscope probe directly at the D and S pins of IC U1 at the bottom side of the board, as shown in Figure 79, to measure drain-source voltage. See figure below for set-up.

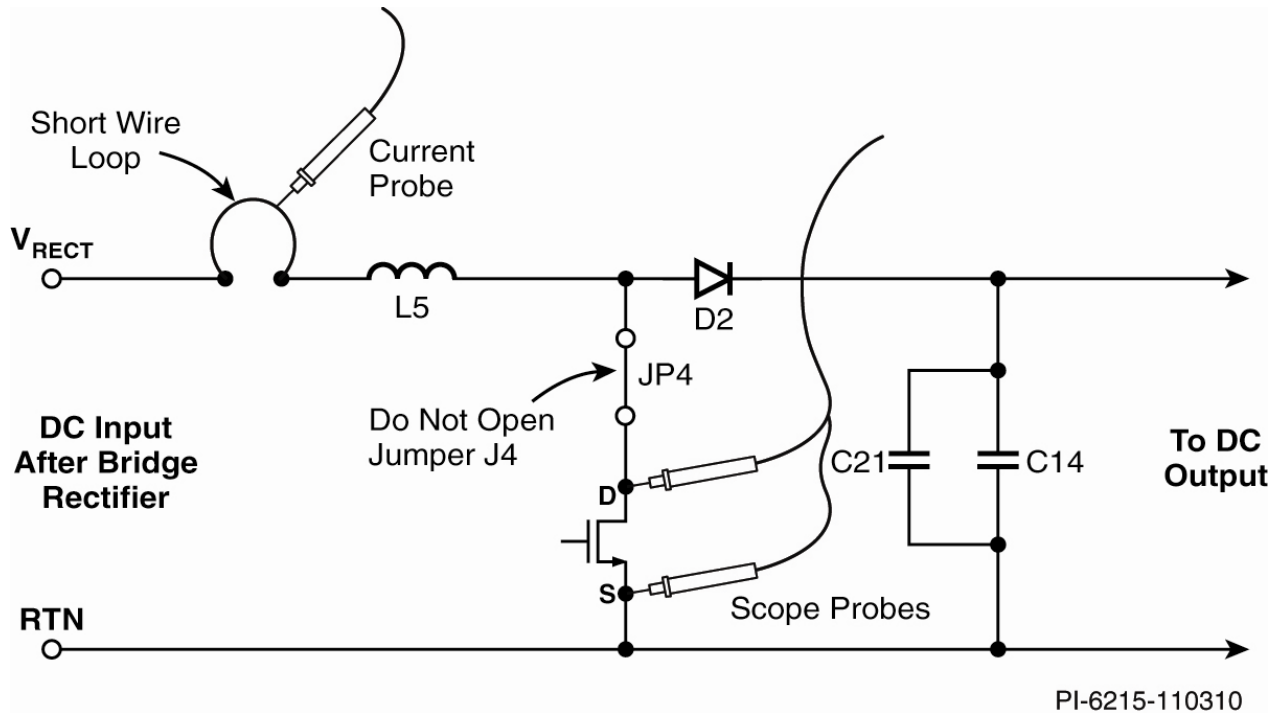
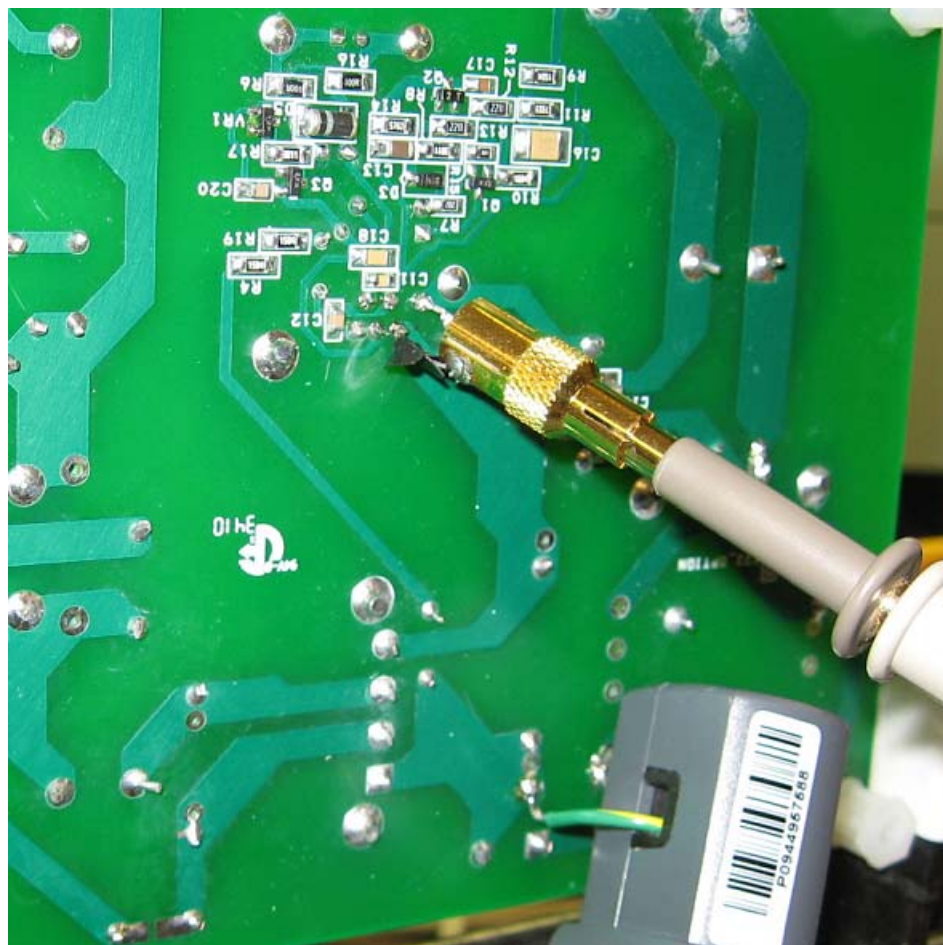
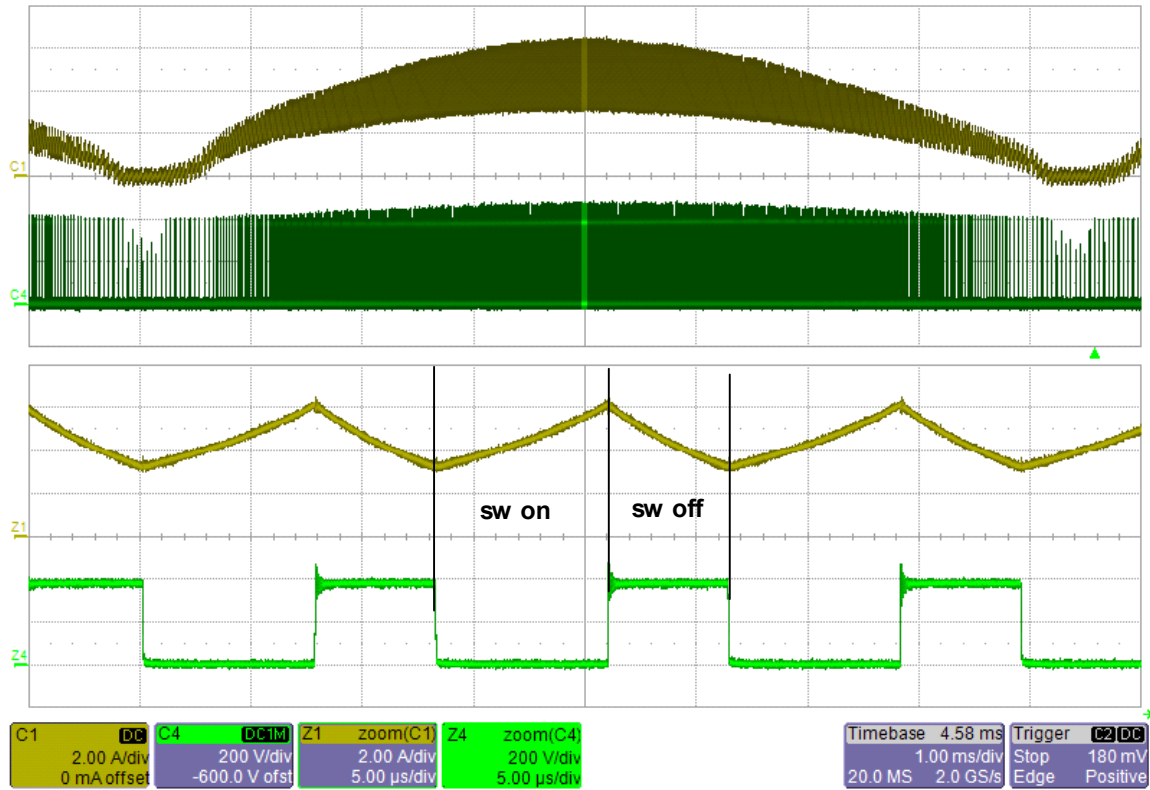


Figure 78 – Current Probe and Scope Probe Jack Insertion Locations.



**Figure 79** – Inductor Current and Drain Source Voltage Measurements Set-up.

MOSFET drain current is same as inductor current when the MOSFET inside HiperPFS is on. When the MOSFET turns OFF, inductor current is same as diode current. When the MOSFET is ON, the inductor current has a positive slope. When the MOSFET is OFF, the inductor current slope is negative. Information about the drain current and shape of drain current can be obtained from the inductor current waveform. This is a safe and recommended method to measure drain current of the MOSFET.



**Figure 80** – 115 VAC, 100% Load.  
Top: Inductor Current, 2 A / div.  
Bottom: Drain Voltage, 200 V / div.  
Zoom Top: Inductor Current, 2 A, 5  $\mu$ s / div.  
Zoom Bottom: Drain Voltage, 200 V / div., 5  $\mu$ s / div.



## 17 Revision History

| Date      | Author | Revision | Description and changes | Reviewed      |
|-----------|--------|----------|-------------------------|---------------|
| 09-Nov-10 | EJ     | 1.0      | Initial Release         | Apps and Mktg |
| 18-Nov-10 | KM     | 1.1      | Minor corrections       | Apps and Mktg |
|           |        |          |                         |               |
|           |        |          |                         |               |
|           |        |          |                         |               |



---

**For the latest updates, visit our website: [www.powerint.com](http://www.powerint.com)**

Power Integrations reserves the right to make changes to its products at any time to improve reliability or manufacturability. Power Integrations does not assume any liability arising from the use of any device or circuit described herein. POWER INTEGRATIONS MAKES NO WARRANTY HEREIN AND SPECIFICALLY DISCLAIMS ALL WARRANTIES INCLUDING, WITHOUT LIMITATION, THE IMPLIED WARRANTIES OF MERCHANTABILITY, FITNESS FOR A PARTICULAR PURPOSE, AND NON-INFRINGEMENT OF THIRD PARTY RIGHTS.

**PATENT INFORMATION**

The products and applications illustrated herein (including transformer construction and circuits external to the products) may be covered by one or more U.S. and foreign patents, or potentially by pending U.S. and foreign patent applications assigned to Power Integrations. A complete list of Power Integrations' patents may be found at [www.powerint.com](http://www.powerint.com). Power Integrations grants its customers a license under certain patent rights as set forth at <http://www.powerint.com/ip.htm>.

The PI Logo, TOPSwitch, TinySwitch, LinkSwitch, DPA-Switch, PeakSwitch, EcoSmart, Clampless, E-Shield, Filterfuse, StackFET, PI Expert and PI FACTS are trademarks of Power Integrations, Inc. Other trademarks are property of their respective companies. ©Copyright 2010 Power Integrations, Inc.

---

## Power Integrations Worldwide Sales Support Locations

**WORLD HEADQUARTERS**

5245 Hellyer Avenue  
San Jose, CA 95138, USA.  
Main: +1-408-414-9200  
Customer Service:  
Phone: +1-408-414-9665  
Fax: +1-408-414-9765  
*e-mail:*  
[usasales@powerint.com](mailto:usasales@powerint.com)

**GERMANY**

Rueckertstrasse 3  
D-80336, Munich  
Germany  
Phone: +49-89-5527-3911  
Fax: +49-89-5527-3920  
*e-mail:*  
[eurossales@powerint.com](mailto:eurossales@powerint.com)

**JAPAN**

Kosei Dai-3 Building  
2-12-11, Shin-Yokohama,  
Kohoku-ku, Yokohama-shi,  
Kanagawa 222-0033  
Japan  
Phone: +81-45-471-1021  
Fax: +81-45-471-3717  
*e-mail:* [japansales@powerint.com](mailto:japansales@powerint.com)

**TAIWAN**

5F, No. 318, Nei Hu Rd., Sec. 1  
Nei Hu District  
Taipei 114, Taiwan R.O.C.  
Phone: +886-2-2659-4570  
Fax: +886-2-2659-4550  
*e-mail:*  
[taiwansales@powerint.com](mailto:taiwansales@powerint.com)

**CHINA (SHANGHAI)**

Rm 1601/1610, Tower 1  
Kerry Everbright City  
No. 218 Tianmu Road West  
Shanghai, P.R.C. 200070  
Phone: +86-021-6354-6323  
Fax: +86-021-6354-6325  
*e-mail:*  
[chinasales@powerint.com](mailto:chinasales@powerint.com)

**INDIA**

#1, 14<sup>th</sup> Main Road  
Vasanthanagar  
Bangalore-560052  
India  
Phone: +91-80-4113-8020  
Fax: +91-80-4113-8023  
*e-mail:*  
[indiasales@powerint.com](mailto:indiasales@powerint.com)

**KOREA**

RM 602, 6FL  
Korea City Air Terminal B/D, 159-6  
Samsung-Dong, Kangnam-Gu,  
Seoul, 135-728  
Korea  
Phone: +82-2-2016-6610  
Fax: +82-2-2016-6630  
*e-mail:* [koreasales@powerint.com](mailto:koreasales@powerint.com)

**UNITED KINGDOM**

1st Floor, St. James's House  
East Street,  
Farnham Surrey, GU9 7TJ  
United Kingdom  
Phone: +44 (0) 1252-730-141  
Fax: +44 (0) 1252-727-689  
*e-mail:*  
[eurossales@powerint.com](mailto:eurossales@powerint.com)

**CHINA (SHENZHEN)**

Rm A, B & C 4<sup>th</sup> Floor, Block C,  
Electronics Science and  
Technology Building  
2070 Shennan Zhong Road  
Shenzhen, Guangdong,  
P.R.C. 518031  
Phone: +86-755-8379-3243  
Fax: +86-755-8379-5828  
*e-mail:*  
[chinasales@powerint.com](mailto:chinasales@powerint.com)

**ITALY**

Via De Amicis 2  
20091 Bresso MI  
Italy  
Phone: +39-028-928-6000  
Fax: +39-028-928-6009  
*e-mail:*  
[eurossales@powerint.com](mailto:eurossales@powerint.com)

**SINGAPORE**

51 Newton Road,  
#15-08/10 Goldhill Plaza  
Singapore, 308900  
Phone: +65-6358-2160  
Fax: +65-6358-2015  
*e-mail:*  
[singaporesales@powerint.com](mailto:singaporesales@powerint.com)

**APPLICATIONS HOTLINE**

World Wide +1-408-414-9660

**APPLICATIONS FAX**

World Wide +1-408-414-9760



**Power Integrations, Inc.**

Tel: +1 408 414 9200 Fax: +1 408 414 9201  
[www.powerint.com](http://www.powerint.com)