

Power Metal Plate™ Current Sense Resistors, Low Value (10 mΩ to 500 mΩ), Surface-Mount, High Power

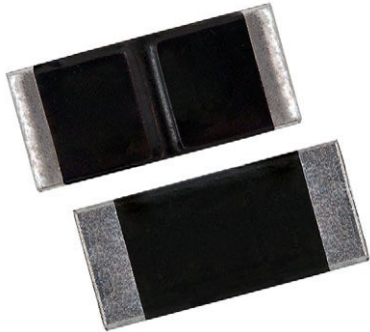

FEATURES

- 2010 and 2512 size package
- Ideal for all types of current sensing and pulse applications including switching and linear power supplies, instruments, power amplifiers, shunts, power inverters, and battery management
- Proprietary processing technique produces low resistance values (10 mΩ to 500 mΩ)
- Solid metal manganese-copper and nickel-chromium-aluminum alloy resistive element with low TCR (< 20 ppm/°C)
- Very low inductance 0.5 nH to 5 nH
- Low thermal EMF (< 3 μV/°C)
- Sulfur resistance by construction that is unaffected by high sulfur environments
- AEC-Q200 qualified ⁽¹⁾
- PATENT(S): www.vishay.com/patents
- Material categorization: for definitions of compliance please see www.vishay.com/doc?99912

 AUTOMOTIVE
GRADE

RoHS
COMPLIANT
HALOGEN
FREE
GREEN
(5-2008)

LINKS TO ADDITIONAL RESOURCES



3D Models



Did You Know?



Videos



Infographics

Note

- ⁽¹⁾ Flame retardance test may not be applicable to some resistor technologies

STANDARD ELECTRICAL SPECIFICATIONS

GLOBAL MODEL	SIZE	POWER RATING ⁽¹⁾ W	TOLERANCE %	RESISTANCE VALUE RANGE Ω	WEIGHT (typical) g/1000 pieces
WFMA2010	2010	3.0 at 70 °C	± 1.0	0.010 to 0.0329	32
WFMA2010	2010	2.0 at 110 °C	± 1.0	0.010 to 0.0329	32
WFMB2010	2010	3.0 at 70 °C	± 1.0	0.033 to 0.500	32
WFMB2010	2010	2.0 at 110 °C	± 1.0	0.033 to 0.500	32
WFMA2512	2512	4.0 at 70 °C	± 1.0	0.010 to 0.0329	41
WFMA2512	2512	3.0 at 95 °C	± 1.0	0.010 to 0.0329	41
WFMB2512	2512	4.0 at 70 °C	± 1.0	0.033 to 0.500	41
WFMB2512	2512	3.0 at 95 °C	± 1.0	0.033 to 0.500	41

Note

- ⁽¹⁾ Terminal temperature

GLOBAL PART NUMBER INFORMATION

Global Part Numbering Example: WFMB2512R5000FEA

W	F	M	B	2	5	1	2	R	5	0	0	0	F	E	A		
GLOBAL MODEL (3 digits)			ELEMENT MATERIAL (1 digit)	CASE SIZE (4 digits)				RESISTANCE VALUE ⁽¹⁾ (5 digits)					TOLERANCE CODE (1 digit)	PACKAGING CODE ⁽²⁾ (2 digits)		SPECIAL ⁽³⁾ (2 digits)	
WFM			A = CuMn B = NiCrAl	2010 2512				R = decimal R0100 = 0.01 Ω					F = ± 1.0 % J = ± 5.0 %	EA = lead (Pb)-free, tape / reel		Dash numbers 1 thru 99 as applicable	

Notes

- ⁽¹⁾ Power Metal Plate™ marking (www.vishay.com/doc?30327); WSL decade values (www.vishay.com/doc?30117)
- ⁽²⁾ Packaging code: EB (lead (Pb)-free) is a non-standard packaging code designating 1000 piece reels. This non-standard packaging code is identical to our standard EA (lead (Pb)-free), except that it has a package quantity of 1000 pieces
- ⁽³⁾ Follow link for customization capabilities: www.vishay.com/doc?48614

PATENT(S): www.vishay.com/patents

This Vishay product is protected by one or more United States and international patents.

TECHNICAL SPECIFICATIONS				
PARAMETER	UNIT	MODEL	RESISTOR CHARACTERISTICS	
			2010	2512
Temperature coefficient (20 °C to 60 °C) (element only) ⁽¹⁾	ppm/°C	All	< 20	
Operating temperature range	°C	All	-65 to +170	
Maximum working voltage ⁽³⁾	V	All	$(P \times R)^{1/2}$	
Maximum terminal temperature	°C	All	110	95
Temperature coefficient (-55 °C to +150 °C) (including terminals) ⁽²⁾	ppm/°C	WFMA	± 110	± 110
		WFMB	± 50	± 50
Temperature coefficient (20 °C to 60 °C) (including terminals) ⁽²⁾	ppm/°C	WFMA	± 30	± 40
		WFMB	± 20	± 20

Notes

- (1) Element TCR - only applies to the alloy used for the resistor element
- (2) Component TCR - total TCR that includes the TCR effects of the resistor element and the copper terminal
- (3) Maximum working voltage - the WFM is not voltage sensitive, but is limited by power / energy dissipation and is also not ESD sensitive

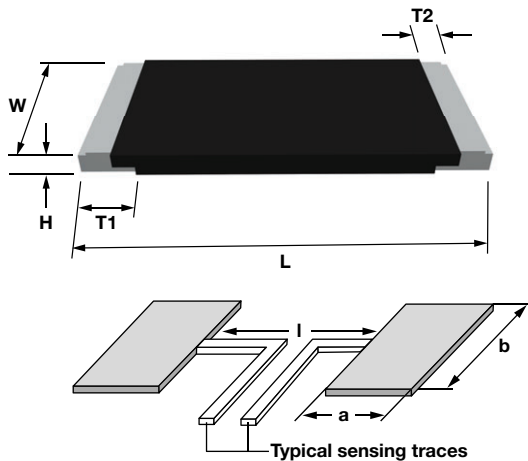
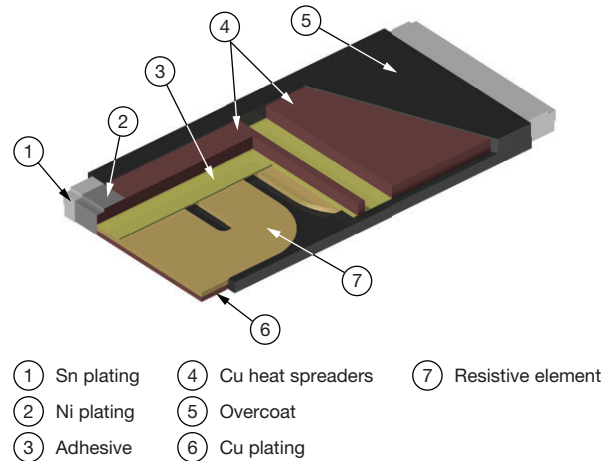
DIMENSIONS

CONSTRUCTION OUTLINE (1)

Notes

- 3D models available: www.vishay.com/doc?30401
- Surface mount solder profile recommendations: www.vishay.com/doc?31052
- (1) For construction advantages and performance details refer to "Did You Know?": www.vishay.com/doc?48567

CASE SIZE	RESISTANCE RANGE (mΩ)	DIMENSIONS in inches (millimeters)					SOLDER PAD DIMENSIONS in inches (millimeters)		
		L	W	H	T1	T2	a	b	l
2010	10 to 500	0.200 ± 0.008 (5.08 ± 0.20)	0.100 ± 0.008 (2.54 ± 0.20)	0.020 ± 0.006 (0.50 ± 0.15)	0.028 ± 0.008 (0.70 ± 0.20)	0.016 ± 0.006 (0.40 ± 0.15)	0.049 (1.25)	0.118 (3.00)	0.138 (3.50)
2512	10 to 500	0.250 ± 0.012 (6.35 ± 0.30)	0.125 ± 0.008 (3.18 ± 0.20)	0.020 ± 0.006 (0.50 ± 0.15)	0.035 ± 0.008 (0.90 ± 0.20)	0.020 ± 0.008 (0.50 ± 0.20)	0.061 (1.55)	0.142 (3.60)	0.173 (4.40)

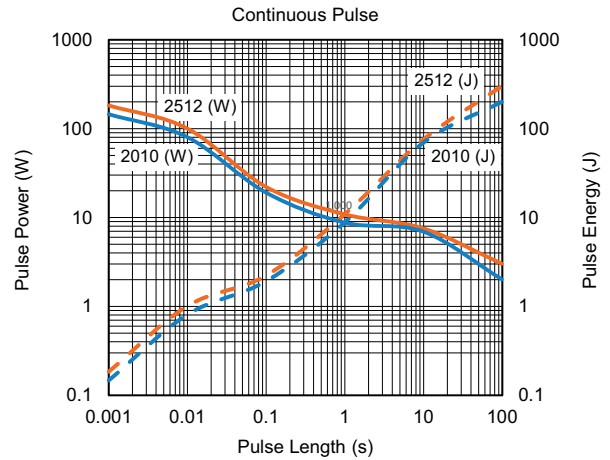
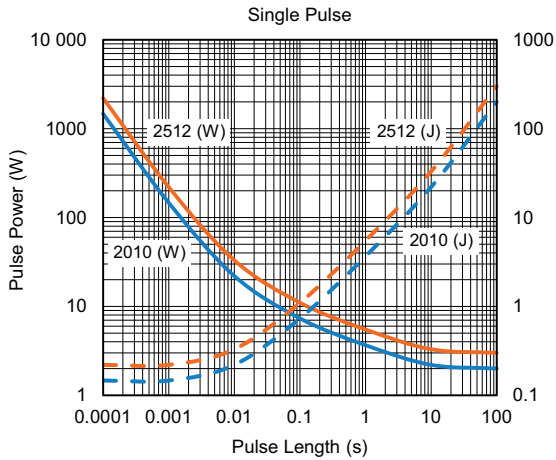
PRODUCT	RESISTANCE RANGE (Ω)	THERMAL RESISTANCE (°C/W)	ALLOY
WFMA2010	0.01 to 0.0329	< 30	Mn-Cu
WFMB2010	0.033 to 0.5	< 55	Ni-Cr
WFMA2512	0.01 to 0.0329	< 25	Mn-Cu
WFMB2512	0.033 to 0.5	< 40	Ni-Cr

PULSE ENERGY AND POWER VS. TIME



Notes

- Data is valid for 33 mΩ. Other resistance values require separate testing
- Continuous pulse chart is tested using a square wave pulse of 10 % duty cycle, not exceeding 0.5 % resistance change

DERATING - TERMINAL TEMPERATURE

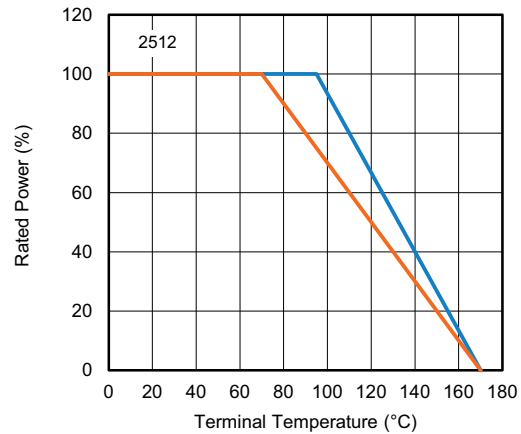
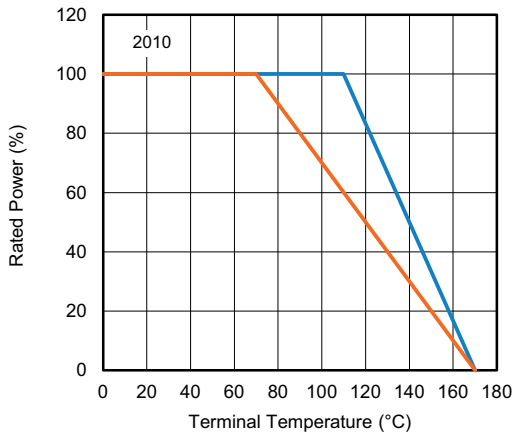

PERFORMANCE				
TEST	CONDITIONS OF TEST	TEST LIMITS	TYPICAL PERFORMANCE ⁽¹⁾	
			CuMn	NiCr
Thermal shock	-55 °C to +150 °C, 2000 cycles, 15 min at each extreme	± 0.5 %	-0.3 %	+0.15 %
Low temperature storage	-65 °C for 24 h	± 0.1 %	± 0.5 %	+0.05 %
High temperature exposure	2000 h at +170 °C	± 1.0 %	-0.18 %	+0.15 %
Bias humidity	+85 °C, 85 % RH, 10 % power, 1000 h	± 0.5 %	+0.1 %	+0.05 %
Mechanical shock	100 g's for 6 ms, 5 pulses	± 0.2 %	± 0.5 %	± 0.5 %
Vibration	Frequency varied 10 Hz to 2000 Hz in 1 min, 3 directions, 12 h	± 0.2 %	± 0.5 %	± 0.5 %
Load life	2000 h at maximum terminal temperature at rated power	± 0.7 %	-0.1 %	+0.1 %
Resistance to solder heat	+260 °C solder, 10 s to 12 s dwell, 25 mm/s emergence	± 0.3 %	+0.15 %	± 0.5 %
Moisture resistance	MIL-STD-202, method 106, 0 % power, 7b not required	± 0.3 %	+0.1 %	+0.05 %

Note

⁽¹⁾ Typical performance is based on summary statistics from qualification data. Performance may vary based on application operating conditions



PACKAGING				
MODEL	REEL			
	TAPE WIDTH	DIAMETER	PIECES/REEL	CODE
WFMA2010	12 mm / embossed plastic	178 mm / 7"	4000	EA
WFMB2010	12 mm / embossed plastic	178 mm / 7"	4000	EA
WFMA2512	12 mm / embossed plastic	178 mm / 7"	2000	EA
WFMB2512	12 mm / embossed plastic	178 mm / 7"	2000	EA

Notes

- Embossed carrier tape per EIA-481
- Additional packaging details at www.vishay.com/doc?20051



Disclaimer

ALL PRODUCT, PRODUCT SPECIFICATIONS AND DATA ARE SUBJECT TO CHANGE WITHOUT NOTICE TO IMPROVE RELIABILITY, FUNCTION OR DESIGN OR OTHERWISE.

Vishay Intertechnology, Inc., its affiliates, agents, and employees, and all persons acting on its or their behalf (collectively, "Vishay"), disclaim any and all liability for any errors, inaccuracies or incompleteness contained in any datasheet or in any other disclosure relating to any product.

Vishay makes no warranty, representation or guarantee regarding the suitability of the products for any particular purpose or the continuing production of any product. To the maximum extent permitted by applicable law, Vishay disclaims (i) any and all liability arising out of the application or use of any product, (ii) any and all liability, including without limitation special, consequential or incidental damages, and (iii) any and all implied warranties, including warranties of fitness for particular purpose, non-infringement and merchantability.

Statements regarding the suitability of products for certain types of applications are based on Vishay's knowledge of typical requirements that are often placed on Vishay products in generic applications. Such statements are not binding statements about the suitability of products for a particular application. It is the customer's responsibility to validate that a particular product with the properties described in the product specification is suitable for use in a particular application. Parameters provided in datasheets and / or specifications may vary in different applications and performance may vary over time. All operating parameters, including typical parameters, must be validated for each customer application by the customer's technical experts. Product specifications do not expand or otherwise modify Vishay's terms and conditions of purchase, including but not limited to the warranty expressed therein.

Hyperlinks included in this datasheet may direct users to third-party websites. These links are provided as a convenience and for informational purposes only. Inclusion of these hyperlinks does not constitute an endorsement or an approval by Vishay of any of the products, services or opinions of the corporation, organization or individual associated with the third-party website. Vishay disclaims any and all liability and bears no responsibility for the accuracy, legality or content of the third-party website or for that of subsequent links.

Except as expressly indicated in writing, Vishay products are not designed for use in medical, life-saving, or life-sustaining applications or for any other application in which the failure of the Vishay product could result in personal injury or death. Customers using or selling Vishay products not expressly indicated for use in such applications do so at their own risk. Please contact authorized Vishay personnel to obtain written terms and conditions regarding products designed for such applications.

No license, express or implied, by estoppel or otherwise, to any intellectual property rights is granted by this document or by any conduct of Vishay. Product names and markings noted herein may be trademarks of their respective owners.